



This is a digital copy of a book that was preserved for generations on library shelves before it was carefully scanned by Google as part of a project to make the world's books discoverable online.

It has survived long enough for the copyright to expire and the book to enter the public domain. A public domain book is one that was never subject to copyright or whose legal copyright term has expired. Whether a book is in the public domain may vary country to country. Public domain books are our gateways to the past, representing a wealth of history, culture and knowledge that's often difficult to discover.

Marks, notations and other marginalia present in the original volume will appear in this file - a reminder of this book's long journey from the publisher to a library and finally to you.

Usage guidelines

Google is proud to partner with libraries to digitize public domain materials and make them widely accessible. Public domain books belong to the public and we are merely their custodians. Nevertheless, this work is expensive, so in order to keep providing this resource, we have taken steps to prevent abuse by commercial parties, including placing technical restrictions on automated querying.

We also ask that you:

- + *Make non-commercial use of the files* We designed Google Book Search for use by individuals, and we request that you use these files for personal, non-commercial purposes.
- + *Refrain from automated querying* Do not send automated queries of any sort to Google's system: If you are conducting research on machine translation, optical character recognition or other areas where access to a large amount of text is helpful, please contact us. We encourage the use of public domain materials for these purposes and may be able to help.
- + *Maintain attribution* The Google "watermark" you see on each file is essential for informing people about this project and helping them find additional materials through Google Book Search. Please do not remove it.
- + *Keep it legal* Whatever your use, remember that you are responsible for ensuring that what you are doing is legal. Do not assume that just because we believe a book is in the public domain for users in the United States, that the work is also in the public domain for users in other countries. Whether a book is still in copyright varies from country to country, and we can't offer guidance on whether any specific use of any specific book is allowed. Please do not assume that a book's appearance in Google Book Search means it can be used in any manner anywhere in the world. Copyright infringement liability can be quite severe.

About Google Book Search

Google's mission is to organize the world's information and to make it universally accessible and useful. Google Book Search helps readers discover the world's books while helping authors and publishers reach new audiences. You can search through the full text of this book on the web at <http://books.google.com/>

9028 1900 54 2

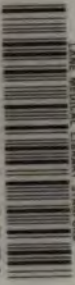

JANE MEDICAL LIBRARY STAFFORD

LANE

MEDICAL



LIBRARY

GIFT
SHRINERS' HOSPITAL

AMERICAN BANK NOTE CO. LITHO

MEDICAL

SHR.

MODERN PHYSIO-THERAPY.

A System of Drugless Therapeutic
Methods,

INCLUDING A CHAPTER ON

X-RAY DIAGNOSIS,

BY

OTTO JUETTNER, A. M., Sc. M., M. D., M. E., Ph. D.,

Professor of Practice at the "Cincinnati Post-graduate School of Physiological
Therapeutics," Associate Editor "Journal of Physical Therapy" and
"International Journal of Therapy," Fellow "American
Electro-Therapeutic Association," Member "Roent-
gen Society," London, England, etc., etc.



HARVEY PUBLISHING COMPANY.
CINCINNATI, OHIO.



1906, BY
THE PUBLISHERS, LONDON, Q.

Digitized by Google

u700
J93
1906

To my Mother.

*"Youth fades; love droops; the leaves of friendship fall:
A mother's secret hope outlives them all."*

—OLIVER WENDELL HOLMES.

PREFACE.

IN submitting this book to the indulgent consideration of my readers I feel disposed to refrain from giving the usual explanation or making the customary apology. The two hundred or more physicians from all parts of the American continent whom it has been my privilege to instruct in the theory and practice of modern therapeutic methods during the past three years, have almost without exception expressed a desire to possess a book of instruction which would enable them to refreshen their memory concerning the theoretical but more especially the clinical features of the work done at the CINCINNATI POST-GRADUATE SCHOOL OF PHYSIOLOGICAL THERAPEUTICS. Thus it seems but fair that those whose enthusiasm for drugless methods and good will for the author were instrumental in the conception and final birth of "Modern Physio-therapy" should shoulder a large share of responsibility if the progeny should prove a disappointment to its parents.

In reproducing my lectures and demonstrations in book-form I have adhered to the spirit and letter of delivery almost throughout, if only to avoid the dryness and orthodox "correctness" of a textbook. Physio-therapy is—in a medical sense—the *living* issue of the day. Hence the realism and fervor of *viva voce* presentation seem appropriate. The reader may miss the half-hearted, semi-apologetic way in which most of the books and journals refer to physiological methods as "valuable adjuncts." In view of the gradually waning drug-superstition and the wealth of light which the natural sciences have shed upon the theory and practice of medicine, physio-therapy does not require any

apologies. We are at this late day prepared to say that physio-therapy and scientific medical practice are well-nigh synonymous. If the reader, after perusing this book, does not agree with this statement, the fault lies with the author whose ability was not equal to the subject,—never with the subject, than which there is none more exacting as far as the knowledge, adaptability and resourcefulness of an author are concerned. I imagine, however, that the book will be found serviceable enough to stimulate further thought and study along physio-therapeutic lines.

The concrete conditions of medical practice give to the physiological methods a place in the treatment more especially of *chronic* diseases. The general practitioner is not so situated that he can practice medicine in a strictly scientific way. He can only be a physio-therapist in a conditional sense. The modern hospital with its facilities and conveniences is the ideal place for absolutely pure medical work in the treatment of both acute and chronic diseases. At the bedside of a hospital-patient the physician need not bow to the prejudices, superstition and ignorance of a patient's family and surroundings. He can allow his scientific conscience to dominate his actions. Habit, diplomacy and a utilitarian sense of making concessions to the lay-mind are bound to influence the actions of the general practitioner in no small degree. When these concrete conditions prevail, physio-therapy has but little chance. A full appreciation of these facts has influenced the plan of the book in keeping with the wants of the general practitioner. This accounts for the great prominence which has been given to the treatment of chronic diseases. Theoretically the book covers the entire field of clinical medicine. There is no doubt in the author's mind that a thorough perusal, study and comprehension of the subject-matter of the first part of the book, more especially the first four chapters, ought to enable any scientific physician to elaborate clinically any problem in practical medicine.

I trust that the book will be received in the spirit in

which it is offered: as an earnest effort on behalf of therapeutic progress. We all love the truth and try to find it. Our *methods* of seeking it may differ. Let those who find fault with the book, its plan, aims or tendencies, attribute its shortcomings to a defect in the *method* and not to any lack of earnest desire and sincere effort.

The most agreeable feature of the circumstances that attended the preparation and final publication of this book is the lively interest with which many of my brother-practitioners far and near rewarded my humble effort. The mere announcement of the book being in course of preparation, culminated in a veritable avalanche of demands for the book, resulting in the issuance of a first edition which is four times as large as was originally intended. For this display of interest and good will I am truly grateful. I hope to be excused for a bit of retrospection which may appear personal to all except those who are in a position to know something about the true inwardness of the subject I am discussing. My experience as a practical exponent of physio-therapeutic medicine has taught me that the practice of modern physio-therapy is not an unalloyed boon. It would require the heroism of a Galilei to not be disheartened amid the pitfalls of open and covert abuse, misinterpretation and calumny which beset the path of him who chooses to pursue the even tenor of his own way. My experience has been a repetition of what has been the lot of others in my line of work. And to think that we all—persecutor and persecuted—are sheltered under the ægis of one great profession! I make these statements on this auspicious occasion in order to encourage those whose hearts may be growing faint. The path of the consistent physio-therapist is up hill. *Per aspera ad astra!* As long as purity of motive and sincerity of effort ease the mind and sweeten the conscience of man, the slings and arrows of outrageous fortune will avail nothing against him.

Those who busy themselves casting the odium of charlatanism upon the practice of physio-therapy, have much to

learn. In fighting physio-therapeutic medicine and surgery they imitate their reactionary brethren of three hundred years ago who called one William Harvey a quack and persecuted him with all the venom and arrogance characteristic of people of their ilk. Let the believer in modern methods who is suffering for a principle, find comfort and solace in the illustrious example quoted.

In conclusion I beg to acknowledge a debt of gratitude to all those who have, in some manner or other, helped to shape the favorable circumstances which have marked the preparation and publication of this book, notably to Dr. John T. Pitkin, of Buffalo, N. Y., to whom I am indebted for the four excellent illustrations of X-ray dermatitis; to Dr. Homer C. Bennett, of Lima, O., author of "The Electro-Therapeutic Guide," through whose courtesy I was enabled to reproduce the splendid diagrams illustrating static technique; to Max Woche & Son, Surgical Instrument Makers, Cincinnati, O.; to the Kny-Scheerer Company, New York; to the F. S. Betz Company, Hammond, Ind.; to the Sanitas Elektrizitätsgesellschaft, Berlin, Germany; to Mr. Richard G. Badger, publisher of the "Archives of Physiological Therapy," Boston, Mass.; to Dr. Clarence Edward Skinner, editor of the "Archives" and author of a valuable monograph on the "Therapy of Dry Hot Air;" to Dr. Gustavus M. Blech, of Chicago, Ills., editor of the "Journal of Physical Therapy," who has given to the profession the English translation of August Bier's important book on "Hyperemia;" to Dr. Wm. B. Snow, editor of the "Journal of Advanced Therapeutics" and author of a good work on static electricity; and to the Electric Dental Specialty Company, Cleveland, O., makers of gloves, etc., for the protection of X-ray operators.

OTTO JUETTNER.

Cincinnati, O., New-Year's Day, 1906.

PART I.
**The Principles of Physiological Thera-
peutics.**

CHAPTER I.

THE PHILOSOPHY OF PHYSIOLOGICAL THERAPEUTICS.

"Some few, whose lamp shone brighter, have been led
From cause to cause to nature's secret head
And found that one fixed principle must be."

—DRYDEN.

THE term "physiological therapeutics" (physio-therapy) is used in contra-distinction to "empirical therapeutics." Some speak of *physical* therapeutics to express the same idea which *physiological* therapeutics is supposed to convey. Practically "physiological" and "physical" refer to the same subject-matter in medicine. In a strictly logical sense, however, the two terms are not synonymous.

Physiological therapy (physio-therapy) is a mode of treatment whose rationale is suggested by the laws of physics and physiology. The term "physiological," therefore, qualifies the meaning of "therapy" by suggesting *the effect to be produced*.

Physical therapy is a mode of treatment by means of forces and agencies that are physical¹ in character. The term "physical," therefore, qualifies the meaning of "therapy" by suggesting *the means which are employed* in producing physiological or therapeutic effects.

From the standpoint of purely scientific medicine the term "physiological" is distinctly suggestive of a principle. The principle is: Therapy must correspond to and supplement established and demonstrable physiological and physical phenomena. The term "physical therapy" does not suggest such a principle. It simply refers to certain agencies

¹The word "physical" is used synonymously with "mechanical."

and means used, irrespective of their (scientific or empirical) character. Physical therapy is not necessarily physiological in character. Physiological therapy can never be empirical while physical therapy may be. As stated above, the two terms are used synonymously in practice, although they, strictly speaking, do not convey the same concept.

The principle which is contained in the term "*physiological* therapy" places this term in logical antithesis to "*empirical* therapy." If therapeutic phenomena are produced by a certain agent, *i. e.* a drug-preparation of some kind, and the same phenomenon has been known to follow the use of this agent at different times and in the hand of different observers, the relation between the phenomenon following and the drug-administration preceding is thought to be that of effect and cause. It is the frequency of the occurrence that suggests such a relationship. The relation is not explained by a logical process of reasoning because it can not be explained in this way. After the drug has been administered, there is a necessary gap in our reasoning. We are expecting something to happen, because it has happened before under similar circumstances. We are satisfied to note the suggestive frequency of the relationship. This is the meaning of *empirical* or experimental therapy.

The so-called physiological effect of a drug is a deduction from the empirical phenomenon which is supposed to follow the administration of the drug. First the drug is administered, then the empirical effect is noted, and from the physical characteristics of the effect the physiological action of the drug is deduced. In applying a physiological therapeutic agent we know the physiological effect before it takes place, because we are familiar with the laws of physics and physiology which control the life of the organism. There is no guess work, no empiricism, no experiment. The effect *must* follow the given cause under given conditions. This is the meaning of *physiological* therapy.

Even the most ardent physio-therapist, however, will admit that the millennium of absolutely scientific medicine

has not as yet arrived. That we have progressed and that we are nearer to it than we were fifty or even fifteen years ago, no one will deny. It can not be gainsaid that we avail ourselves of certain methods to-day that are purely scientific and can not and should not be compared with the empirical drug-methods of the past and present. These scientific methods are mechano-therapy, hydro-therapy, thermo-therapy, photo-therapy, and above all the fundamental branches of medical practice, to-wit: hygiene and dietetics. Electro-therapy, including X-ray therapy, is not on the same plane of scientific exactness. Both the character of the agent employed and the nature of the effect produced are subject to speculation. It is a strange fact that of all these modern methods, those that are truly scientific have not achieved the degree of professional favor and popular applause which has been accorded to electro- and radio-therapy in spite of the markedly experimental character of the latter.

The first step in our reasoning must be the clear recognition and statement of the premises. We must try to understand the subject-matter before we can grasp its basic logic and extraneous relations. What is meant by health? What is disease?

In viewing the human body from its origin to its dissolution through various stages of development, the most striking feature of its life is the apparent unity of intention manifested in the preservation of the integrity of the whole and in the mutual co-operation of the parts. There is not only life, but coincidentally the manifest desire to live in a state of the highest relative perfection. The living body contains an ever-active principle which guards the structural and functional integrity of every part and counteracts within the limits of its potency any internal or extraneous agencies which threaten such integrity. It tends toward a certain standard of well-being under any and all circumstances. The action of this principle or vital force, considered *per se*,

is LIFE itself,—in its relation to the body and the parts thereof whose structural and functional perfection this force unceasingly tends to preserve and restore, it is HEALTH. Life and health are, therefore, the same concept from two different points of view. In its efforts to counteract inimical elements or to repair damage, it presents itself as the force which medical men for want of a better name have designated as the *vis medicatrix natura*. The period of activity of this principle in its restoring or repairing efforts is DISEASE. It is clear, therefore, that disease is not an entity, not a something definable, having clearly marked attributes, entering the body in a certain way, causing certain disturbances and producing certain ultimate effects. Disease is the force or principle of life (health) viewed in its efforts to protect, preserve, restore or to repair whenever the structural or functional perfection of the body or any part is endangered or impaired. To consider a disease an entity *per se* would be fundamentally erroneous. Life, health and disease are, to all intents and purposes, only different aspects of one and the same concept.

Let me interpose that the activity of the life-principle in the individual body is analogous to the action of a corresponding force which is manifest in the existence and regeneration of the species. Nature protects the individual body in very much the same way as it guards the integrity of the species of which the individual body is a part. There is the same uniformity of intention in the aggregate (species) as well as in the integral (single body). In either there is the manifest desire or tendency to live in a state of relative perfection. The species demonstrates this tendency, not only by propagation of its integrals, but by sacrificing an imperfect part in the interests of the whole. This, for instance, is illustrated by the manner in which Nature tries to prevent the propagation of syphilitic or tubercular stock and thus prevents degeneration or corruption of the species. The unhealthy offspring dies in early childhood or even during fetal development. Thus the integrity of the species

is guarded. Analogously the body will survive at the expense of a part,—for instance, in the case of a felon. Rather than allow the morbid material of a felon to be absorbed into the general circulation and poison the whole system, Nature makes an effort to isolate the poison, even if the suffering part, *e. g.* a phalanx, is destroyed in the effort of getting rid of the poison. In the species as well as in the individual body, the integrity of the part is invariably inferior to the integrity of the whole. The species lives at the expense of the integral, analogously the body lives at the expense of the part, the organ at the cost of the cell. It is the universal struggle which ends in the survival of the fittest (Darwin). The "fitness" of the integral is determined by a fixed criterion of the viability possessed by the species. The fitness of the species as expressed in the preservation of its integrals is the viability (fitness to live) of the integral. Whenever the fitness of the part falls beneath the fitness of the whole, the part as such ceases to be viable, *i. e.* the part is destroyed by a more or less rapid process of dissolution. The process of dissolution may extend over a number of generations² before Nature's object, *i. e.* to destroy a deteriorating member of the species, is accomplished. Upon this fact rests the biological explanation of heredity, atavism, etc. Thus, the scrofulous condition of an individual may be a part of a process of destruction which began two or three generations ago and ends in the extinction of a non-viable family. To the physician this process presents itself as a state characterized by lessened or entirely suspended activity of the *vis medicatrix naturæ*. There is no attempt at restoration or repair, no "disease" in the sense suggested above. This distinction contains all the logic of pathology. Disease is never a something *per se*, a something passive or

² The same may be said concerning qualitative *improvement* of the species as expressed in the relative perfection of an individual. Mental or physical improvement or deterioration is a process which concerns the species. The individual simply typifies a phase in the process. There is no doubt that criminals as well as gentlemen are made a hundred years before they are born.

static; it is not a condition, but a process; not an accomplished thing, but an accomplishing movement. It means either return to normal conditions or dissolution *in parte* or *in toto*. Clinically this biological concept of disease means everything. If disease is a well-planned restorative or destructive effort, it stands to reason that Nature does not proceed in a blind, purposeless or haphazard manner, but follows a certain method. To define and understand this method is the object of scientific medicine, to co-operate with and supplement Nature's method is the task of the physician. The statements made convey the great fundamental truths upon which all rational medicine rests. The study of medicine logically resolves itself into an analysis of the phenomena of life (health or disease) and the mode of action of the vital principle under various conditions. To cure disease means to direct the activity of the vital principle in its efforts to bring the body or any part back to the normal state of well-being and in removing whatever obstacles might impede the work of this ever active force. Medicine, therefore, is an analytical science and by its very essence discountenances any tenets except those established by critical analysis,—*quod erat demonstrandum*.

In the light of the statements made we are prepared to look upon diagnosis as being the discernment, not of a condition produced by some internal or external cause, but rather as being the recognition of the cause itself. Biologically the disease-process must appear to the physician as the effort made by the vital principle to counteract the cause and remedy its effects. Logically, therefore, the physician must be in sympathy and in co-operation with disease. His province is to understand Nature's efforts, to direct them into the proper channel and to augment them in keeping with their ultimate purpose. This strictly scientific view of the subject will enable us to construct a groundwork upon which we can erect a rational system of medicine. Physiological medicine is based upon facts, not upon coincidences,—upon demonstration and knowledge, not upon as-

sumption and belief. Thus, the physician must be a medical philosopher whose realm of thought is bounded only by the confines of truth, and should not be hemmed in by impenetrable walls of preconceived ideas, prejudices, schools and isms.

Since, as has been suggested, the knowledge of disease is substantially the clear recognition of the various causes, and of the means which Nature adopts in counteracting them and in restoring normal conditions, it stands to reason that we must above all things try to identify and classify these causes. In a general way we may say that these causes are either contained in the organism or are introduced from without, *i. e.* they are either internal or extraneous. We can conveniently recognize a third variety, comprising the action and effects of physical or mechanical forces acting upon the organism from within and without.

INTERNAL CAUSES.—The objective manifestation of life in the human body is the process of nutrition by which all the parts of the body are kept intact and normally active. The chemical and physiological elements of the organism are constantly regenerated by the taking up of corresponding material from without, principally through the digestive and respiratory organs. These elements are distributed to the body at large through the structures composing the circulatory system (lymph- and blood-vessels). Material which is unavailable or has been utilized and is ready to be cast off, is gotten rid of by the excretory organs (lungs, kidneys, bowels, skin). The internal causes of disease are the disorders affecting the whole or any part of this triple process of taking up food-elements, assimilating them and casting off waste material. Under this caption would come all disturbances of nutrition, local and general, (inflammations, active and passive congestions, anemia, all disturbances of the hematopoietic process, interference with the chemical or physiological composition of the blood, thrombus, embolus, neuralgia, rheumatism, etc., etc.). Most

nervous diseases belong under this head since they are primarily disturbances of the blood-supply to certain nerves or nervous areas, likewise all catarrhal conditions. A second series of internal causes comprises the vast number and variety of conditions in which there is impairment of physiological digestion, assimilation of food-elements, etc., etc. A third series includes all disorders of excretion (imperfect or perverted function of the skin, kidneys and bowels, diabetes, all forms of auto-intoxication, perhaps all malignant diseases, although the latter are probably with more propriety classifiable under the head of increased or perverted nutrition).

EXTRANEOUS CAUSES.—Under this head belong all causes originating outside of the body and in reality foreign to the organism (vegetable and animal parasites, paludal, chemical and physiological poisons). The diseases due to these extraneous causes are principally tuberculosis, all the acute infections, tetanus, typhoid and typhus, trichinosis, helminthiasis, scabies, tinea, all parasitic diseases of skin and mucous membranes, malaria, conditions produced by chemical poisons, drugs and gases, ptomain-infections, etc., etc.

MECHANICAL CAUSES.—These causes are agencies operating according to the general laws of physics. All traumata belong under this head, being the effect of the action of mechanical forces, *i. e.* wounds, contusions, the presence of foreign bodies, ruptures, fractures, luxations, compressions, strangulations, etc., etc., and the conditions accompanying or following them. Conditions produced by increased, lessened or misdirected blood-pressure are included in this category, *e. g.* the results of disturbance of the hepatic or portal circulation, the various organic, particularly valvular, diseases of the heart, etc.

These causes might operate singly, successively, or conjointly. It devolves upon the clinician to analyze the individual case and identify the causes and their relations to each other. Thus, gall-stones, being concretions of one of

the normal digestive secretions, belong to the first variety of causes. If they should obstruct the common duct and thus give rise to distention of the gall-bladder and to all its distressing symptoms, the conditions produced would be classified under the third variety. If a perforation should occur, giving rise to a purulent peritonitis, the presence and activity of pyogenic organisms would suggest the second variety of causes.

The above classification is the first step toward the establishment of a rational pathological method. Biologically, disease receives its identity from the cause or combination of causes which it tries to correct or combat. Nature always adapts means to the end. We can, therefore, assume that the disease-process will plainly indicate the means which Nature adapts to the end, *i. e.* by which Nature re-establishes normal conditions. Hence, there is contained in the analysis of disease (1) the clear conception of a cause or a combination of causes, and (2) a sharply defined method which Nature adopts in its efforts of repair. Therefore it is plain that the idea of treatment in any given case is in reality suggested by the analysis of "disease" in connection with recognized laws of physics and biology, and the established principles of hygiene and physiology. Treatment is to all intents and purposes the physician's way of cooperating with, augmenting or anticipating Nature's plan. It is the logical correlative of disease, and can, therefore, never be vague or symptomatic unless the physician bluntly admits his inability to analyze and, therefore, his ignorance of a given case. In order to establish a rational system of medicine it is necessary to study Nature's bedside-method which might justly be called "clinical physiology."

The Rationale of Disease and Symptoms.

Whenever any of the causes mentioned begin to act upon the organism, either singly or conjointly, there is a coincident response on the part, not only of the structure attacked, but in a greater or less degree on the part of the whole sys-

tem. The response will correspond to the nature of the cause, to its relative speed of action, to its intensity, to its more or less continuous character, and to certain peculiarities of the cause or causes, or of the structures acted upon. This response is the series of subjective or objective symptoms accompanying disease. Symptoms bear the same relation to disease (or restorative effort) which language bears to thought,—they are the outward form of disease, but not its substance. They are guide-posts along the path of identifying an active cause. Biologically there are two kinds of symptoms: (1) *Causal symptoms, i. e.* those directly due to the activity of the cause (*e. g.* pain caused by a wound, dyspnea produced by a distended stomach, nervous disturbances due to ptomain-intoxication of the cerebral centers, etc.); (2) *Restorative symptoms, i. e.* those produced by and accompanying the disease-process proper (elevation of temperature accompanying fever, hyperemia coincident with active absorption, diarrhea following intestinal indigestion, etc., etc.). The classification given above seems scientifically exact and clinically useful. This will become more apparent as we progress in the discussion.

An ordinary case of typhoid fever will illustrate these points. Typhoid fever is due to an extraneous cause, *i. e.* the entrance into the organism of vegetable parasites which attack the intestinal surface at certain places of selection, giving rise to ulceration of the places attacked, and after entering the general (lymph- or blood-) circulation, either *per se* or through certain morbid products generated by them, bring about a condition of poisoning. The entrance of the germs and their subsequent absorption is the cause,—Nature's effort to eject the germs and their products, to heal the intestinal ulcers, and to repair whatever damage has been done, is the disease. Clinically, typhoid fever presents an array of causal and restorative symptoms. Thus, pain in the right iliac region, malaise, mental hebetude, delirium are causal symptoms; diarrhea, fever, diaphoresis are restorative symptoms. To the thoughtful observer there is a

great deal of logic in the semeiology of a condition. Thus, pain points to an affected part and is Nature's demand for rest; anorexia is Nature's warning that the digestive apparatus is impaired. Similar examples could be quoted *ad infinitum*. Treatment should be the assistance we give Nature in its efforts. It would be absurd to stand at the bedside and deliberately cover up a causal symptom or hide a restorative sign without connecting either with the element of causation or restoration, from which neither can logically be separated. The distinguishing feature of the true physician is not the euphony of scientific terminology or depth of therapeutic resources, but the intelligence of action. Thus, fever suggests to the true physician Nature's attempt to accelerate tissue-change and regenerate the organism by intensified oxidation, the object being the elimination of some material or element foreign to the organism. The thoughtless empiric sees in the fever, not the means, but the end; not the remedy, but the disease. He aims at the fever as the thing to be attacked, to be treated. Incidentally let me say that there is hardly a subject in medicine the biology of which is so generally misunderstood and misapplied by most physicians as "fever." The great hydropath, Priessnitz, was wont to say: "What a glorious achievement it would be to find a way of producing fever and controlling it as a remedial agent in the treatment of chronic diseases! What wonderful results would crown our efforts!" Only the man who is a biological thinker can appreciate the meaning of this remarkable statement made by one of the keenest clinicians in medical history.

It can not be repeated too often, nor impressed too deeply, that disease is not an entity to be removed by treatment, but that it is a physiological movement toward repair or destruction of the organism or some special part. To treat disease, scientifically means to understand this movement, and assist it in taking a certain course. It behooves us now to apply to concrete conditions the principles conveyed.

The Rationale of Treatment.

Before there can be any thought of helping Nature to restore normal conditions it is essential to bear in mind the general laws which govern the life and well-being of the human body while normal conditions prevail. These laws apply to the sick body with even more force than to the healthy body. They constitute the groundwork of scientific medicine, and necessarily take precedence of any methods we might devise, however rational the latter might be. These fundamental laws which control the health of the human body are the principles of *hygiene* and *dietetics*.

Hygiene aims at the establishment of the surroundings and outward conditions which the human body requires for its well-being, and at the removal of deleterious elements. Hygiene provides air and light as required by the organism, regulates the periods of activity and rest of the body and its parts, inquires into the sanitary condition of our surroundings, enforces cleanliness of the surface of the body, examines into the manner in which our bodies are clothed, and removes all external influences which might impair the integrity of the body or any part. Hygiene is of supreme importance to the body in the state of health, and, therefore, most emphatically so in the state of disease. Hence, the first duty of the scientific physician in the treatment of any diseased condition is the enforcement of the fundamental laws of hygiene. Numerous diseased conditions are due to the violation of hygienic principles. Analysis of the case should reveal the cause and point to methodical enforcement of the law which has been violated, as the logical treatment. Nature will gladly restore health if given a chance and assisted in an intelligent way.

The science of *dietetics* is likewise of fundamental importance. The physician should be equally familiar with the physiology of the alimentary canal and the chemistry of foods. Since the stomach performs the lion's share of function in supplying fuel to the slowly oxidizing organism, the knowledge of dietetics is of special import in all conditions

which are characterized by intensified and accelerated oxidation (fever). A thorough knowledge of dietetics leads to a clear conception of the physiology of the process of excretion (throwing off waste through the skin, lungs, bowels, and kidneys), impairment of which constitutes the pathology of not a few diseases. The physician having familiarized himself with the hygienic and dietetic requirements of the *healthy* human body is able to think physiologically in adapting any special mode of treatment to the *sick* body.

In keeping with our previously given classification of causes of disease we can analogously classify the methods of treatment. Disturbances of the triple process of nutrition (nutritive function of lungs and alimentary canal, assimilation through the lymph- and blood-circulation and elimination of waste through the excretory organs) can be controlled if we are able to control the physiological functions which are affected. Thus, if we are able to, by some method, cause hyperemia or anemia of any part of the body at will, we can certainly control a disease which is due to a disturbance of the blood-supply of the part. If the lungs, for instance, are hyperemic, and in spite of nature's effort at unloading the over-supply by absorption or increased skin activity, the congestion continues, an inflammatory condition of the lung will be the result. It stands to reason that the logical way of meeting the exigencies of such a condition is to apply some method by which the over-nourished lungs can be unloaded without detriment to the organism at large. Thus, if we are able to force enough blood into the lower extremities so that they will hold three times the normal quantity, it stands to reason that the quantity of blood normally present in the trunk and head is correspondingly lessened,—there must necessarily follow an unloading of the congested lungs. Are there methods by which the circulation can be thus controlled and diseases due to internal causes influenced? Can we cause hyperemia of an organ and thus stimulate its functional activity? Can we counteract a hyperemia and thus prevent, jugulate or lessen an in-

flammation? Can we increase the activity of the skin and thus encourage excretion? Can we relieve passive congestion? Can we influence the absorption of exudates? Can we accelerate, retard, or modify the process of nutrition locally and generally? If there are methods which are capable of producing these effects, we are ready to admit that medicine within the range of their usefulness is a science. To illustrate these points let us refer to some of these strictly physiological methods in their practical application at the bedside. By way of contrast, let me briefly discuss the subject of empiricism, both as a part of rational medicine and as a species of charlatanism.

Empirical Methods.

By empirical methods are meant modes of treatment based upon experience without, however, admitting of demonstration of their *modus operandi*. The relative value of an empirical method is determined (1) by the regularity with which an effect follows the activity of a certain cause, *e. g.* the administration of a certain drug, and (2) by the degree of knowledge we have concerning the effect in all its aspects. Thus, if we administer quinin to a malarial patient, and produce a decided effect, even to the extent of causing morphologically destructive changes in the plasmodium, we *might* consider this effect a *propter hoc* as well as *post hoc*. Yet this method is not a physiological one, because while we can connect cause and effect we can not define the connection. What becomes of the quinin after absorption, what chemical changes it undergoes, what chemical and physiological elements of the organism it affects, how it affects them, its *modus operandi* in disintegrating the plasmodium, we can not demonstrate.

To practically illustrate the distinction between a physiological and an empirical method let us consider the case of a patient who is suffering from a severe congestive headache. If we give this patient a moist pack from the feet to the costal border and find the patient within a few min-

utes relieved of his pain and ready to fall asleep, we are fully conscious of the physiological process through which this effect was produced. Dilatation of the vessels of the region packed is followed by contraction of the cerebral and meningeal vessels (Schüller's classical experiment with rabbits). The effect is a lowering of intracranial blood-pressure and a cerebral anemia. The result is relief and somnolence. This is the clinical application of a *physiological* method. If, instead of being treated according to the above plan, the patient is given ten grains of phenacetin and should find himself relieved, the therapist would tell us that coal-tar products depress the heart and thus lower the blood-pressure, hence the relief. *How* the effect is produced, is subject to physiological speculation. The therapist has seen the same effect, with more or less promptness and intensity, follow the administration of the drug. His statement is a generalization of a proposition based upon repeated experience. He associates effect and cause, but does not and can not define the nature of the association. He presumes, but he can not demonstrate. After producing the effect he assumes a physiological *modus operandi* instead of demonstrating the physiological action in its various relations to the organism, and then letting the clinical effect follow as a necessary sequence, just as a conclusion follows its premises. In regard to the moist pack the conclusion (clinical effect) follows the premises (physiological demonstration). Every link of the argument is complete and clearly set forth. The action of the moist pack upon the skin, upon the cutaneous vessels, upon the subcutaneous structures, can be seen and measured by the senses and by physiological instruments (Schüller's experiments on rabbits, Goltz's experiments on frogs, Winternitz's observations on animals and patients, Ludwig's investigations concerning the "thermic" sense of blood-vessels, etc., etc.). Not so in regard to phenacetin or, for that matter, any drug taken internally. What becomes of the drug after absorption, what path it takes, what chemical changes it undergoes, what physiolog-

ical elements it attacks, how the organism as a whole and in its parts responds to the presence of the foreign substance, —all these are uncertain, ill-defined links in our argument. As long as they are, the use of drugs can not rise to the dignity of a scientific or physiological method. The cause may be clear, the effect may be distinct and characteristic, yet the method is empirical as long as the *nexus causalis* is a physiological speculation only.

The internal administration of drugs is an art and not a science. Drug methods can never be free from uncertainty and doubt. Yet, while drugs do not cure or heal, they are frequently capable of relieving certain urgent symptoms without detriment to the organism. Even then they are at best but necessary evils. The longer we practice, the more skeptical we become in regard to the *materia medica*. The scientific physician prescribes little and rarely. The gun-shot prescription is notoriously an indication of an unscientific mind, for the intelligent physician tries to be exact and to the point even in his symptomatic therapy.

Materia medica is the least important branch of medical teaching because it contributes the smallest share to scientific medicine. It owes its prominence to the efforts of those who make their school or pathy or ism the criterion of scientific medicine instead of proceeding *vice versa*. Its empirical character caused Mephisto to utter his caustic criticism about doctors and their work:

“The work of doctors is not hard to grasp;
They rack their brains, and study high and low;
Yet in the end the sick get well or gasp
Their last, if Mether Nature wills it so.”

(Goethe's *Faust*.)

In view of the vast amount of quackery which is practiced at the bedside under the guise of therapeutics, would that the last two lines of Mephisto's remarks were true! What a boon it would be to suffering humanity to be left expectantly alone and at the tender mercies of ever-merciful

Nature! Nature is, indeed, generous and indulgent to a fault. The poor typhoid-fever patient who for weeks has been persistently dosed with some coal-tar product, survives, though his blood has been subjected to constant deoxidation and his red blood-corpuscles have been destroyed in vast numbers. His heart bears up under the double burden of the fever-process and the drug-depression. Nature opens up the pores of the patient's skin to eject the offensive substance. The patient finally recovers, in spite of the so-called treatment,—an anemic or even cyanotic semblance of his former self. This kind of empiricism savors of blatant quackery. Even from the standpoint of symptomatic treatment it is totally unjustifiable.

It is plain that the external use of chemical agents is not open to these objections because—*ceteris paribus*—their *modus operandi* or rather *medendi* can be made as clear and logical as any laboratory-experiment, *e. g.* the use of silver nitrate on a mass of unhealthy granulations or the application of a solution of corrosive sublimate to an exposed surface representing an immense culture-bed of pus-producers. The action of these purely chemical agents is well-defined, and for this reason is a logical major premise in the argument. The minor premise is the clinical problem to be solved. If the reasoning of the physician in regard to the existing state of affairs is as sound as the logic presented by the drug-agent and its chemical and physiological potency, the conclusion, *i. e.* the treatment adopted, must be correct. Such a therapeutic method is physiological. Internal medication can never be a logical argument of this kind, because both premises are incomplete. This reason accounts for the notorious discrepancy of opinions among doctors in regard to internal medication. The chemical use of drug-agents is subject to analysis and is, for this reason, never a bone of contention. The physiological therapist aims at a complete and thoroughly correct clinical syllogism. Drug-therapy can not be logical in this sense. Any substance that enters the organism through the channels of

assimilation must necessarily be either a food or a poison. There is no other alternative. That which is supposed to be a physiological effect, *e. g.* the diaphoretic action of jaborandi or the cathartic effect of calomel, is nature's means of getting rid of a poisonous substance. That drugs are capable of producing effects on the system, no one questions. All poisons have some sort of action. The fallacy of drug-medication consists in the assumption that these ill-defined and ever-variable drug-effects are curative in the sense of influencing a disease-process physiologically. Thus, the physiological therapist establishes the same criterion for all agents that are used in the treatment of disease. In availing himself of the poisonous effects of some drugs he chooses the lesser of two evils, *e. g.* he prefers a mild degree of opium-poisoning to severe suffering. This is a mode of action which the concrete conditions of practice require, *e. g.* the anodyne action of morphin, the anaesthesia produced by chloroform-poisoning, the parasitocidal action of antiseptics, anthelminthics etc. The argument between physiological and purely empirical (drug-) methods refers to their relatively *curative* action in influencing a pathological process, using the word "curative" in its most exacting physiological sense.

Physiological Methods.

Among the methods which are in accord with biological reasoning and, therefore, might be designated as being strictly scientific, *hydro-therapy* occupies a most conspicuous place and may well serve as a type for illustration. In order to illustrate the theoretical points of our discussion about the rationale of physiological methods, I shall confine myself to pointing out the salient features of hydrotherapeutics as a typical physiological method.

Water as a carrier of temperature is the agent *par excellence* by which we can control at will the circulation of the whole body and of any part. By exposing the surface of the body to the action of cold (heat) we can cause a

condition of cutaneous anemia (hyperemia) and coincidentally a congestion (depletion) of the deep vessels. Likewise, we can by increasing the blood-supply of any special part cause a corresponding decrease in some other part. Goltz has shown that it is possible to almost entirely deplete the head and the extremities and crowd all the blood into the abdominal vessels. The strictly physiological action upon the sensory cutaneous nerves, and through these upon the central and peripheral ganglia controlling the vasomotors and thus upon the muscular coat of the cutaneous blood-vessels, necessarily affects the process of nutrition, of tissue-change (oxidation), of absorption and excretion. By hydrotherapeutic means we can arbitrarily accelerate or retard these processes, both locally and generally. An inflammatory process in any part of the body can be acted upon in any stage. During the stage of congestion it can be aborted or jugulated by drawing the blood into some distant part, thus depleting the affected area and depriving the inflammatory process literally of its working capital. In cases in which the stage of congestion is over and active inflammation has been established, the hydrotherapist again avails himself of the "derivating" action of water, and controls the severity of the process by carrying off the surplus blood crowding in upon the inflamed area. By acting upon the surface of the whole body he causes the body to oxidize more rapidly and absorb and excrete the products of inflammation. Thus he intensifies the action of Nature's greatest restorative agent, the fever-process proper. The physiological constituents of the body are regenerated, proving that water after all is directly *the* great alterative or blood-purifier. To be able to arbitrarily control the quantity of blood and the rapidity of circulation in any part, means to be able to control nutrition, to relieve active and passive congestion, to promote the metamorphosis of tissue, to encourage absorption and excretion. The vast usefulness of "derivating" water-applications can be best appreciated when we compare the results we achieve, with the uncertainties

and disappointments of drug-medication, especially in the treatment of chronic diseases, *e. g.* such conditions as chronic rheumatism, malaria, abdominal plethora, etc., etc. The marvelous effect of water-applications is emphasized by such an authority as Henoeh, who quotes the following interesting case of a gastric neurosis in this connection: A lady whose stomach would not retain any food and even rejected water, was given up to die. A last attempt at treatment was made by a French hydrotherapist, who immersed the patient's feet up to the knees in hot water and applied a (cold) Kneippdouche to the head. The effect was remarkable. The sensory gastric nerves, which had been irritated by the passive congestion in the walls of the stomach, and perhaps, too, by the endless number and variety of drugs administered, became quiet in consequence of the "derivating" and the reflex sedative effect of the water-applications. The lady made a prompt recovery.

That the therapy of water has received so little attention from the majority of the profession is, in view of the strictly scientific character of the method, somewhat surprising. With the exception of the cold sponge-bath, the moist pack, and the hot-water immersion-bath in surgery, physicians know very little about water and its universal applicability and efficacy. And yet, as a remedial agent, it is infinitely superior to any drug, or combination of drugs. The study of the physiology, therapy and technique of *external* applications of water (hot, warm, lukewarm, and cold baths; douches, sponge-baths, complete and partial moist packs, sweat-baths, etc., etc.), and likewise of the *internal* uses of water (irrigation of stomach and intestines, drinking of water of various temperatures, etc., etc.), forms one of the most fascinating subjects in medicine. Incidentally, let me say that water is not the only carrier of temperature for clinical purposes. The thermotherapist frequently avails himself of air, in order to apply heat or cold, with gratifying results. By way of illustration, let me refer to the use of hot air in cases of chronic rheumatism, in fact

in all cases in which accelerated oxidation, or tissue-metamorphosis, in the affected part is desirable. I remember the case of a woman who had a stiff, painful knee for many months, and after taking medicines without limit, was cured completely in one week by the daily use of the hot-air chamber, into which the limb was introduced. The physiology of these applications is as simple as it is exact.

Another important physiological method is *massage* or the manual or instrumental manipulation of the tissues for a variety of purposes. Its effects resemble those of hydrotherapy. It affects local circulation, and in this way local nutrition, tissue-change, absorption and excretion. It restores impaired innervation, gives tone to the muscular coat of the arteries, and promotes the activity of the absorbent vessels, relieving passive congestion and encouraging the absorption and excretion of morbid material. It supplements the action of water most effectually. It would take me beyond the confines of my present subject to discuss at length the subject of physiological massage. I wish, however, to correct the current impression that the practice of massage is beneath the dignity of the physician. This impression is the result of the erroneous notions entertained by the profession in reference to massage. The application of massage as a muscular and nerve tonic in cases of general debility and neurasthenia is only a small part of its field of usefulness. For these purposes it is the proper province of the professional masseur. There are many cases, however, in which massage requires the *tactus eruditus* of the educated physician. Whenever it is desired to cause the absorption of inflammatory products or to break up adhesions or cicatricial tissue by massage, the physician should be the masseur. Pelvic exudates (Thure Brandt's method), chronic inflammatory swellings (rheumatic and otherwise), chronic synovites, etc., are of this character. It is remarkable how promptly the affected parts respond to treatment. It is not generally known that massage is an anodyne of great virtue, especially for the relief of rheumatic and neuralgic pain. It

regenerates the part by relieving passive congestion, stimulating arterial circulation, and thus produces a powerful alterative effect upon the nutrition of the part. As an analgesic its action is prompt, *e. g.* in cases of torticollis, lumbago, pain in any of the accessible muscles of the body. In such cases the "laying on of hands" (by way of massage) will at times lead to miraculous results. During the treatment of a fracture or luxation, massage helps to reduce swelling and to preserve the functional usefulness of joints and muscles. Massage is a valuable adjunct to the treatment of many surgical³ conditions. Its technique is as exact as its *modus operandi* is scientific. The same may be said of certain other physiological methods which operate according to the same principles, *e. g.* the various forms of gymnastic therapeutics, Swedish movements, etc., etc.

A strictly biological concept of disease should be the basis of our therapeutic methods. Let us rise out of the foggy recesses of exclusive drug-methods into the pure atmosphere of physiological reasoning. The drug-dispenser is never an exact thinker. He could not be if he would. He many times hovers dangerously near the border-line of quackery. If he is conscious of this fact (and I dare say most physicians are), his mind is ripe for newer and better therapeutic ideas and methods. He is ready and willing

³ Incidentally let me say that physio-therapy is in principle and practice the ally of conservative surgery or the surgery that aims to preserve structure rather than mutilate or destroy it. The discovery of anæsthesia, the principles of surgical cleanliness, and the Esmarch method of bloodless operations, have made invasion of the body by the knife comparatively safe. This fact accounts for the great strides that have been made in the department of operative surgery and the assiduous cultivation of mechanical skill on the part of the operating surgeons of to-day. Whether the operative surgery of to-day signifies actual scientific progress in medicine is more than questionable. During the times of Billroth, Langenbeck, and Gross the essence of surgical education was the knowledge of *when* and *why* to operate. To-day it seems to be all-important to know *how* to operate. Such is the effect of the example of a mechanical genius like Lawson Tait on the many men of much smaller caliber who attempt to follow in his footsteps. This accounts for the present age of unnecessary operations. Clinically operative surgery thrives

to share in Nature's restorative work, not merely to go through the motions before his patients and prescribe something—"ut aliquid fiat." In most cases it is commendable to sit idly by and let Nature do the work. This is the success of homeopathy.

The physio-therapist should be physiological, not only in his methods, but more especially in his ratiocinations. He must absorb the spirit of physiological therapy, not merely its practice. To apply the methods without being imbued with the spirit of their rationale is an injustice done to the most glorious achievement that has marked the history of clinical medicine. In doing clinical work try to elaborate within your minds the philosophical axioms embodied in the practice of drugless medication. After you have made the philosophy of physiological therapeutics a part of your inner consciousness, you will realize that you are not merely adding a new method or two to your way of practicing medicine, but that your work has become the embodiment of a new principle which, in its last conclusions and applications, means the disintegration and ultimate destruction of *faith* in the *art* of medicine and aims at the establishment of knowledge of the *science* of medicine.

at the expense of other lines of practice. That a reaction is bound to follow this era of surgical overwork, especially in gynecology, is plain to any one who is familiar with the history of medicine and knows the causes that led up to the present dominating influence of operative surgery. The development of conservative methods along physiological lines will eventually force surgery into its proper place as the handmaid of medicine. Abstracting from the glamour of a modern surgical operation and the mechanical skill displayed, there is usually not much of the true scientific medical element in it. Lawson Tait and his disciples defer a diagnosis until after the abdominal section. Joints are resected that might be restored, amputations are made that might be avoided, etc., etc., etc., *ad absurdum*. The physiological therapist has a well-equipped armamentarium to choose from before he resorts to the knife. Mechanical skill should not be the end and purpose of surgical education, but always be the means to the end. This statement characterizes the attitude of physio-therapy to surgery.

CHAPTER II.

PERSONAL HYGIENE.

"I have thought that some of Nature's journeymen had made men and not made them well, they imitated humanity so abominably."—SHAKESPEARE.

HYGIENE (from the Greek *hygieia*—"health") is the science of preserving health and preventing disease. It involves the knowledge of all the means and agencies by which the health of the organism, wholly and in part, is sustained. It deals with the various potencies and activities by which disease is produced.

Inasmuch as hygiene is the science of preserving health, it is practically synonymous with *applied physiology*, using the latter term in its widest biological sense. Physiology indicates the principles of animal life, hygiene suggests their application. Hygiene, therefore, presupposes the knowledge of physiology.

The science of preventing disease necessarily depends upon the various agencies and potencies by which disease is produced. It presupposes the knowledge of heredity, etiology and pathology, using the latter term in its widest biological sense. Thus hygiene is synonymous with *prophylactic medicine*.

An exhaustive treatise on hygiene would practically be a complete exposé of medicine and the collateral sciences. In a restricted sense we may refer to hygiene as a therapeutic agent. As such it represents an important branch of physio-therapeutic medication. It involves the forces that affect the body of man directly and the immediate agencies

which commonly are concerned in the production of the various ills to which his organism is liable to fall a victim (*personal* hygiene).

The physical condition of man to-day represents a more or less well-marked deviation from the natural standard. His occupation, his manner of living, his diet, his environments, his habits, are all calculated to impair his vitality and to cause partial or general deterioration and collapse. The demands of Nature are constant and fixed. Health depends upon certain conditions. In proportion as man complies with Nature's demands he will enjoy a corresponding degree of health. Let man deny nature's demands *in toto* or *in parte* and a proportionate amount of normal well-being will be denied to him. Disease does not put in a haphazard appearance. It follows like a logical sequence to the premises furnished by man. I have stated on another occasion, and beg to repeat and emphasize it, that the normal man as intended by nature is not the average man as produced by twentieth-century civilization. There are a thousand illustrations which might be adduced in explanation and corroboration of this statement. Thus, the modern city is like an immense prison wherein individuals and families vegetate, deteriorate and finally succumb. In spite of all our vaunted progress it can not be denied that man has improved only in accidentals, but is becoming more and more woefully deficient in essentials.

In treating the sick human body the physician's concepts of hygiene should resolve themselves into a continued effort to restore natural conditions and environments and to encourage man to return to the natural standard. Let the physician beware lest he forget the fundamental laws of health while he is busily engaged in remembering and prescribing the latest remedy for the relief of some conspicuous symptom. We live in an age of contradictions and absurdities. The ubiquitous medicine-bottle looms up like a specter of long-forgotten days, while anatomy, physiology, hygiene, dietetics and other branches of purest medical

science can only be found on the shelves of medical libraries, carefully secured behind lock and key lest they escape.

In presenting hygiene as a therapeutic measure in a practical form, we can summarize hygienic philosophy in the old and trite but eternally true saying of the father of medicine: "A man with active emunctories (skin, lungs, kidneys and bowels) can not be sick!" Apply this statement logically and consistently to its very last consequences and you will establish a system of personal hygiene as perfect and modern as any man could to-day. The function of the four emunctories should, therefore, receive the first and constant attention of the physician in the treatment of disease.

Before proceeding to consider these and other special aspects of therapeutic hygiene, let me interpose a short reference to a feature of our subject which is not directly connected with the clinical purposes which we, in the enforcement of hygienic rules of action, may have in view, but which is nevertheless closely interwoven with the physician's work and its ultimate objects. Men and more especially women sacrifice many a hygienic principle to a perverted sense of the beautiful. A truly æsthetic appreciation of the glorious masterwork of construction which the human body in its perfect lines and proportions represents, is a species of education of untold hygienic value. A sick, sickly or sickly-looking body is not beautiful. Man can not improve upon the splendid beauty of form and proportion which an all-wise Providence designed. An appearance of beauty must convey a suggestion of health and hygienic perfection. An attempt to mutilate or deform the human body is an æsthetic crime and a hygienic outrage. To impair the physical perfection of the body and to undermine its health in order to satisfy notions and fancies of a perverted or morbid character are insults offered to what Ludwig Buechner calls the godlike dignity of the human frame. Think of the ear-rings which are worn in imitation of the habits and customs of savages. Think of the modern high-

heel shoe with its necessarily disastrous results on the poise of the whole superstructure and the perversion of the purpose which nature had in view in planning the human body and its finely adjusted bony frame. Think of that typical example of concentrated ugliness, the narrow waist, and that most cruel of modern instruments of torture, the tight corset, the disease-producer *par excellence*. Amid the men who, by virtue of their profession or their office, are to take care of the health of the people, there is not one who does not fully realize and understand the position of the tight corset as a pathogenic factor with a most sorrowful record. Why are disease-producers like this not fought like the tubercle-bacillus, etc.? Indifference in this respect and frantic sanitary activity in other directions,—what a satire on human intelligence and modern civilization! Nature is all beautiful, and true culture never offends against the intentions of Nature. Modern man and modern woman constantly do. The Indian who paints his forehead, cheeks and chin with gaudy colors, and decorates his head with feathers, beads and other ridiculous trinkets, while the scalp of a vanquished foe dangles from his belt, seems to be the prototype of the modern woman with powder and paint, with feathers and plumes, that speak many a mute but eloquent necrologue on behalf of the gay songbird whose tuneful lays were hushed when the singer was sacrificed in the interest of a woman's headgear. Try to behold before your mind's eye the classic type of feminine beauty, the Milesian Venus, clad in a waist-constricting corset. Fancy her going through equilibristic performances on high-heel shoes, crowned with what looks like a hybrid between a botanical collection and an ornithological museum, while the thousand fragrant odors that emanate from her suggest the incense that the lord of creation offers up to his gaudily attired and gaily decorated mate. Surely the modern female biped must be a mental imbecile. This is the only plausible explanation of and apology for the insults to her physical perfection to which she constantly submits. In fulfilling your mis-

sion as physicians, remember that you, as Hyrtl says, are to be apostles of true culture (hygiene of the mind). You are to be missionaries of that eternal religion which is preached in eloquent language by the myriads of stars above, by the merry songsters of the woodland, by the flowers that scent the shady banks of the brook and the sun-kissed brow of the distant hills. Teach your patients to have respect for the human body. Make them understand that normal form and natural function are the prime conditions of health and, therefore, of beauty. Having done so, you can begin to teach them the principles of personal hygiene.

In applying the Hippocratic admonition concerning the four emunctories let us briefly consider the hygienic importance of the skin, the lungs, the kidneys and the bowels.

FUNCTIONS OF THE SKIN.—Physiologists tell us that the skin is an organ of excretion as well as of respiration. A man in good health loses by the skin in twenty-four hours approximately 1-25 of his body-weight. The skin resembles the lungs in its function, in that it takes up oxygen and excretes carbonic acid. The skin is the great thermic regulator of the body. Therein lies its clinical importance. It is the protective covering of the body, at once shielding the latter and communicating outside impressions to the various parts of the body.

What animal-heat means to the organism will be seen later on under the head of Hydro-therapy. The very life of the organism is bound up in the process of oxidation. Radiation of heat-units constantly takes place through the skin in the form of gases, vapors or even liquids. Through the skin we can influence the fever process, the metabolic changes in the organism and thus the very life of the latter. It is plain, therefore, that the skin should receive a large share of clinical attention. It not infrequently is the barometer by which conditions within are indicated. It serves as a sort of dumping-ground for the inactive sewers of the body, and becomes the seat of various forms of morbid conditions that are secondary to functional disturbances

in the organism. Non-parasitic skin-diseases are never primary or local affections. They are evidences of trouble somewhere in the machinery of the body and should be looked upon as symptoms and not as diseases *per se*. (See SKIN-DISEASES.)

It is easy to understand why the face is more frequently the seat of skin-disease than any other part of the body-surface. It is exposed to light and air more and, therefore, is functionally more active than any other portion. The skin of the face is doing compensatory work and is, therefore, the seat of continuous congestion. Hence the frequency of facial skin-troubles. Exposure of the body at large is the beginning of logical treatment.

The care of the skin depends on three factors of cardinal importance, to wit: cleanliness, air and light. Before clothing was invented, the skin was well-nigh able to take care of itself. The skin being exposed to air and light was kept hygienically clean. Excretion was unhindered. The dew of the morning, an occasional rainfall or a bath in the inviting waters of a crystal-clear brook removed the deposit of dirt from the skin of primeval man. Fresh air and light kept the skin functionally active and the organism at large free from slack. This was in the happy days when even fig-leaves were a luxury and when man in all his pristine perfection traversed the fields and meadows pure at heart and beautiful like all of Nature's works. *Naturalia non sunt turpia!* Eternal vigilance and constant physical strife kept him in prime condition. Disease was unknown beyond the injuries that were incidental to his mode of living.

Compare these splendid physiological conditions with the innumerable hygienic sins which the average man of to-day, who is the prisoner and victim of unhygienic environments and health-impairing influences, commits. The skin of the average man in the large towns who is poor and vegetates in the dust-laden atmosphere of a factory and in the ill-ventilated and badly lighted prison-cells of a tenement-house, is necessarily covered with a slimy and mal-

odorous mixture of sweat, sebaceous material and oil from the cuticle. There is no sunlight, no fresh air to cleanse and disinfect his skin. Eventually the functional activity of the skin is impaired and favorable conditions are created for the development of the thousand and one forms of auto-intoxication. Thus the vitality of the body is lowered and the soil rendered fertile for the reception and development of microscopic scavengers. The resisting power of the organism sinks below par. Thus liability to sickness and premature death are the inevitable result.

The beneficent hygienic effects of air and light on the skin, and thus on the whole organism, can not be overestimated. In all diseases of metabolism, the sun-bath should be given a foremost therapeutic place. The skin in all febrile conditions and all wasting diseases requires light and air, for obvious reasons. In all chronic diseases the patient's skin should receive the benefit of the alterant action of light and air. This and the use of water should be insisted upon as a matter of routine. Light and air are never contra-indicated. Remember this more especially in connection with that most neglected portion of our anatomy, the feet. Exposure to light and air is a prophylactic of prime importance and a therapeutic agent of marvelous power.

It would carry me too far to fully discuss the hygienic aspect of *clothing*. The object of clothing should be to cover those parts of the body which conventional notions teach us to cover, and to protect the body against cold. It should not interfere with the function of the skin. This refers more especially to underwear which should be loose and of wide texture. Woolen underwear is nearly always objectionable. The outer garment should be of denser texture in order to protect the body against atmospheric moisture. Tight fitting clothing is never proper. Loose garments do not interfere with evaporation. The air should circulate freely between the skin and the clothing and between the different layers of the latter for purposes of ventilation. In addition it must be remembered that this volume of

air in itself plays the part of an article of clothing because it prevents the too rapid radiation of heat. Underwear should absorb moisture, the outer garment should not; both, however, should be poor conductors of heat, but should not be air-tight. In a general way, it must be admitted that the tendency is towards too much clothing. Perversions of taste and sense, as displayed in the garments especially of women, are prolific sources of bodily ills. A book might be written on the diseases and diseased conditions produced by high-heel shoes and tight corsets.

The care of the skin involves strict enforcement of cleanliness through the consistent and liberal use of soap and water. This should be the beginning of the hygienic regime in all chronic disturbances of nutrition and metabolism. Soap and water are never contra-indicated unless the skin itself is the seat of disease and forbids violent manipulation. Discourage the habitual use of warm or hot water. Cold water is the skin-regulator *par excellence*, unless there are special indications against its use, *e. g.* in cases of chronic nephritis and whenever skin-reaction, owing to loss of vascular tone, is absent or deficient.

FUNCTIONS OF THE LUNGS.—The stomach is sometimes referred to as the furnace which receives the fuel, and by burning it up keeps the fire of life from going out. In reality this simile does not hold good. The stomach prepares the fuel for the burning-up process. The latter takes place in the lungs. The lungs take up the oxygen from the air. Over a space of from eighteen to twenty-two square feet (for such is the extent of the breathing surface in the chest) oxygen is absorbed by the blood, is carried by the coloring matter of the red blood-cells to all parts of the organism and acts upon the combustible constituents of the body. The principal waste left from this burning-up process (oxidation) is carbonic acid, which is excreted by the lungs and discharged with the exhaled air. Complete exhalation never takes place. Even after forced expiration there still remains a volume of residual air in the chest

(about one hundred cubic inches). About twenty cubic inches of air are taken in and given off during each act of normal respiration. Physiological oxidation requires a corresponding amount of oxygen. Thus we see that metabolism or the constant regeneration of tissue depends on normal lung-function. The clinical significance of this statement becomes apparent when we consider that in most chronic diseases we are dealing with disorders of metabolism.

Oxygen is the life-element *par excellence*. The first principle of hygienic medication, therefore, is to supply the organism with oxygen (fresh air) and to preserve the oxygen-receiving and oxygen-carrying power of the body. Sunlight has a marked affinity for oxygen. Therefore, fresh air and sunlight represent an inseparable duality. The perfection of the mechanical act of respiration is necessary for the proper reception of oxygen. From a clinical point of view, therefore, the hygiene of lung-function consists in giving the body fresh air and sunlight and in training the individual to practice the mechanism of respiration in as perfect a manner as possible.

In proportion to the physiological perfection of oxidation, the body will possess the power of resisting the deteriorating effects of disease-producers. The less oxygen is actually utilized and consumed, the less resisting power the body possesses. The oxygen-consumption of the organism determines its degree of vitality. Both are in direct proportion to each other. This is a hygienic and therapeutic principle of overtowering significance. Disease-producing germs can not gain a foothold and will not grow and thrive, unless the vitality of the organism is low enough to make the latter a favorable soil for germ-culture. Micro-organisms are ubiquitous. Every one of us is exposed to the same danger of infection. Some are infected, others are not. Some recover, some succumb. The pathogenic germs are present everywhere and invade the organism of every one within reach of infection. The tubercle-bacilli are indigenous in every community. Every one of us, at some

time or another, inhales these germs. Yet only a certain number of individuals are infected and contract bacillary phthisis. Why do others escape? A better opportunity will never offer itself for the discussion of the peculiar changes which the study of microscopic life has wrought in our clinical reasoning. The undue prominence of bacteriology (biology of germs) has detracted from the attention to which physiology (biology of the animal body) is entitled. The former has only a secondary importance as compared to the latter, which by its very nature must come first in theory and practice.

Bacteria, like all plants, require a soil to furnish the necessary conditions favorable to their development. Without a suitable soil or culture-medium germs can not grow. It is evident, therefore, that the preparation of the soil is the life-condition of the germ and its growth. The crusade against tuberculosis should not primarily be a warfare against the bacillus. The latter can be left out of consideration because its life and growth are secondary to the condition of the tissues of the human organism. These are the soil. Render the soil sterile and tuberculosis will, after another generation or two, be stamped out of existence. Teach the individual and the community the first principles of hygiene in connection with their mode of living; compel them, if need be, by main force to practice hygiene in taking care of their bodies, and the tuberculosis-problem will solve itself. This dire and murderous affliction is the logical punishment which nature metes out to those who sin against fundamental hygienic principles. The offender may be an individual, a family, a tribe, a race. In the struggle for existence the fittest, *i. e.* the most viable, is bound to survive. Appease outraged Nature and the ban is lifted. If the hygienic quality, *i. e.* the resisting power of the body, is kept at a certain level, the tubercle-bacillus is not any more to be feared than the numberless forms of microscopic plant-life that inhabit Nature's vast domain. The term "scavenger" is distinctly relative in its meaning. In discussing

the philosophy of physiological therapeutics I had occasion to refer to that ever-present and ever-active tendency of Nature toward a standard of perfection characteristic of every species. The activity of the scavenger is the outward expression of Nature's desire to destroy what falls beneath this standard of specific perfection. Nature invariably sacrifices the individual to the species, the part to the whole. In this sense the activity of the scavenger is *constructive* to the species while it may be *destructive* to the individual. The scavenger is a pathogenic element in this provisional sense. The treatment of a tubercular subject is a problem of sanitation with a wide economic meaning. It really involves a triple task, to wit: 1. To protect the integrity of the species (prevention of marriages between consumptives or, for that matter, all individuals whose physical standard is below that of the species); 2. To remove hotbeds of scavenger-breeding from our midst (by isolating all consumptives) and 3. By giving each consumptive patient the benefit of a rational therapeutic regime.

To be able to cope with great problems of sanitation and hygienic therapy, such as indicated, a thoroughly conscious appreciation of the physiological meaning of lung-function is necessary. The lungs of the average person offer a surface of approximately twenty square feet to the oxygen-laden air. The process of physiological combustion ("life") depends on the supply of oxygen and its proper usage in the system. There are four important lessons in therapeutic hygiene contained in this statement: *Fresh air* to furnish oxygen; *light* to aid in the assimilation of oxygen; *gymnastics of the thorax* to preserve the mechanism of respiration in a state of relative perfection; *muscular exercise of the whole body* to preserve the physiological equilibrium in the exchange of gases. In all chronic diseases, especially of the blood and the respiratory organs, this fourfold aspect of lung-function should be the beginning and the basis of our therapeutic reasoning.

FUNCTIONS OF THE BOWELS AND KIDNEYS.—The com-

bustible material which is acted upon by the oxygen in the body and slowly consumed, enters the body mainly through the stomach in the form of food. We can easily understand the physiological wisdom in the Hippocratic dictum concerning the four emunctories. Slow oxidation means life. In the process of physiological oxidation the four emunctories play the most essential part, and, therefore, they are the true pillars of life.

The functions of the bowels and kidneys are properly discussed under the head of alimentary hygiene or dietetics. The latter deals with the quantity, quality and preparation of food, with the physiological purposes of food, and with the therapeutic application of the principles involved. While it is properly a part of personal hygiene, it covers an immense field and comes home to the individual patient more than any other part of hygiene. I have, therefore, thought it wise to consider dietetics separately.

I can not refrain, however, from calling attention to a few characteristic points in connection with alimentary hygiene. Bad habits are not infrequently the cause of disease. The constipated hypochondriac is probably the only person who has the true heartfelt appreciation of the privilege, the luxury and the happy possibilities of a good *evacuation*. The latter is a boon to be thankful for and an accomplishment to be proud of. Frederick the Great, who was as much of a philosopher as he was a strategist, was discussing the wants of the common soldier on the field of battle. A field-chaplain suggested that the soldiers before a battle should be taught to pray. Frederick opined that soldiers who fall on the field of battle have done their full duty and would, therefore, go straight to heaven. Those who survive have plenty of time to pray after the battle. The chaplain thought that soldiers ought to be prepared in some manner or other. Frederick said: "Fill their powder-bags and empty their bowels; all else is of no consequence."

People should be taught to have some respect for the calls of nature and extend this respect to others who might

be called. Catherine of Russia subordinated even diplomatic functions of state to the peristaltic function of her large intestines. No assemblage of princes and diplomats, however distinguished and brilliant, superseded in her mind the importance of alimentary excretion. On one occasion a gorgeous delegation of Oriental potentates had to wait over thirty minutes while Her Imperial Majesty occupied the throne where no one else could have taken her place. To-day—with more definite knowledge of hygiene—people are afraid to do the bidding of nature for fear of giving offense or because they are denied the chance. They invite the legion of troubles and complaints¹ which follow the disregard for the demands of health. Children in school, women in the midst of social obligations, men in business suppress and ignore what ought to be a welcome invitation. Thus a race of constipated malcontents is being bred in an age of alleged enlightenment. In some of our large cities where health-officials arrest a man who is supposed to aid in the propagation of tuberculosis by expectorating on the sidewalk, there are no public commodities for the relief of urgent necessities. Thus the spread of disease is encouraged among the human species, while horses, cows and dogs are well and happy in the enjoyment of the unconditional privilege of depositing their alimentary excreta unhindered on the public highway. *O tempora! O mores!*

The hygiene of the alimentary canal requires a sound and healthy condition of its several parts. The *mouth* should

¹Auto-intoxication from the residual matter in the large intestines is by many considered the most prolific cause of disease and of the many phases of decay and retrograde metamorphosis included under the head of senility (BOUCHARD, METSCHNIOFF). There seems to be no doubt that man would be better off without his large intestines. After many ages of evolution man will no doubt be freed from the encumbrance of an appendage which is not only unnecessary, but a constant source of infection, disease, and decay. The future man, under these improved conditions, will be in his prime when he reaches the biblical allowance of threescore and ten. Metschnikoff thinks that health (life) depends upon the degree

receive its share of attention. It should be washed out, especially in the morning. The teeth should be fit for their work of thorough and *slow* mastication. In this age of superior dental surgery there is no excuse for poor teeth. They are not infrequently the cause of disease. Other points in connection with the subject of alimentary hygiene I will have occasion to discuss under the special head of Dietetics.

The hygienic importance of *water* is not appreciated as it should be. It is nature's beverage and can never be supplanted by artificial substitutes like beer, wine, coffee, tea, soda-water, etc. Father Kneipp, who was not a scientist, but made up for the lack of scientific training by a liberal supply of common sense, discountenanced the use of artificial beverages as substitutes for water. In his characteristic picturesque language he appeals to his fellow-men to return to the simplicity and frugality of former, physically stronger generations, and refers thus to water: "You that are sickly and weak, nervous and irritable, that distend your stomachs with thin beer and strong coffee; you that reek with the dirt and filth of ill health,—go and take from the hand of Nature the goblet of life filled with the pure, cold, crystalline blood of the meadows and mountains!" People do not, as a rule, drink enough pure water. The bulk of it should be drunk between meals, not during meals. Like a cadaverous voice from a musty grave comes the admonition of the modern health-officer to *boil your drinking-water*.

of phagocytic power possessed by the corpuscular elements of the blood. He believes that the human body is the battling ground and that a continued contest takes place between the normal cell-elements of the blood and the microscopic intruders from without. The problem of sustaining life (health) consists in preserving the fighting quality of the red corpuscles. This quality is contained in the hemoglobin, the oxygen-carrier. Gaseous combustion-products in the blood disintegrate the hemoglobin. Since the large bowel is always filled with these waste-derivatives, and since absorption from the large bowel constantly takes place, we are prepared to understand the pathogenic importance of auto-intoxication.

Pettenkofer, of Munich, declared that he would rather eat live germs than dead ones, that he would rather make an aquarium than a cemetery out of his stomach. Boiled water is stale water and can never take the place of fresh water. If water is infected, it should be filtered, aerated and exposed to light. Geisler's experiments show that typhoid bacilli die, if the water containing them is aerated and exposed to sunlight. Oxygen and actinic rays of light are nature's own disinfectants. Water, after aeration and transillumination, can be cooled and served. The proper management of the water-supply in large cities is an economic and hygienic problem of stupendous importance. It involves the health of thousands of people. It is a problem which should be solved by men who have brains and hearts, and independently of politicians and rotten municipal governments. "The health of the people," says Lord Beaconsfield, "is the first duty of the statesman." Again we arrive at the same hygienic principle which teaches us that bacteria are not pathogenic unless the soil is favorable to their development. A healthy human body is proof against these microscopic scavengers. All these problems can be solved by making physiology and hygiene a part of the practical education of the people. Little Japan might in this respect serve as a shining example for the white races of the East and West that have had a monopoly on civilization.

The liberal use of good drinking water is probably the best tonic that the physician can recommend. It keeps the kidneys active, prevents passive congestions and dilutes the renal excretion. There is hardly a condition in which water as a beverage is not indicated. Further reference to this important subject will be made under the head of Dietetics.

It would be foreign to the purposes of our discussion to enter into the details of a subject of such proportions as hygiene. The question of sex, age, race, heredity, contagion, infection, environment, occupation, habit, etc., offer a vast field for research and speculation. The many aspects

of domestic and civic hygiene are of absorbing interest and vital significance. I wish to restrict myself to what might be designated as therapeutic hygiene or hygiene as a therapeutic agent in the treatment of disease. I wish to emphasize the essentials of hygienic treatment in as far as they concern the physician in his clinical work. In the treatment of chronic diseases the tide is not infrequently turned in the patient's favor by the correction of a violation of some hygienic principle. Many a patient goes from one physician to another without receiving any benefit until some simple phase of his case is discovered that clears up the situation. It is notoriously a fact that the elementary truths of medical science, the simplest laws of health, are not infrequently disregarded by the physician who takes too much for granted in investigating his patient's case or who tries to find something unusual which his predecessors have failed to discover. Five good clinicians in succession examined and treated a case of epilepsy in a young woman. The patient became worse until an old practical country doctor took hold of the case, stopped all medication, made the patient discard her high-heeled shoes and thus cured her. Her epilepsy was a reflex neurosis. (See REFLEX DISORDERS.) The simple fundamental laws of health which culminate in the hygienic importance of air, light, exercise, proper food, cleanliness and excretion, have lost none of their importance. They have become more significant and necessary because the tendency of modern man is to deviate from the normal standard more and more. The stereotyped advice given to patients to "get out more and take more exercise" should be formulated by a deeply rooted and conscious appreciation of light, air, exercise, etc., etc., as therapeutic agents of fixed value in a given case. For this reason I have availed myself of this opportunity to emphasize and repeat things that every schoolboy is supposed to know, and that many a doctor forgets when it is most essential that he should remember them.

The patient's daily life offers many a problem for investigation and solution. Try to connect his condition or some conspicuous feature thereof with the kind of work he does, the position of his body during his working hours, the amount of recreation and sleep he gets, the bodily and mental influences to which he is exposed at different times or under various conditions, the manner in which he eats and what he eats, the amount of physiological exercise, light and air he gets, how his home-surroundings might react upon him, and a thousand other circumstances suggested by the personality, the surroundings and mode of living of your patient. Remember the all-powerful influence of mind over body, and analyze the factors that are liable to react upon his mind and through it upon his body. The mind should be at ease before we can hope to re-establish the equipoise of the physical man. More frequently the body acts upon the mind. In such cases the body must be regulated before we can hope to remove the mental effect. The mind is as much a part of the man as the body. Either must suffer through the afflictions of the other.

The attempts which have been made to impress the mind of patients through the *organs of special sense*, especially the eye and the ear, have not only shown the value of sensory suggestions, but have opened up a wonderful field of clinical and experimental possibilities especially in the treatment of nervous disorders. The development of the beauty-sense by a well-planned system of æsthetic culture has become a recognized branch of therapeutic hygiene.

The effects of different colors and their combinations on the eye, and through the latter on the nervous system, can be made therapeutically available. The colors of the solar spectrum represent distinct physical potencies. Beginning with the red end of the spectrum and gradually passing through the green field to the violet end, the effects on the animal organism, respectively, are stimulating and sedative. Finsen himself, who was not a poetic dreamer but an exact scientist, attributed the healthful influence of life

in the country in no inconsiderable degree to the prevalence of blue and green (sky and vegetation). That the undulations of light do not affect merely the nerve-structure of the eye but exercise an inestimably profound influence over the molecular elements of matter and their vibratory life-manifestations (see chapter on FORCE-MODALITIES), is sufficiently well established to justify further speculation along these fascinating border-lines of a new and tempting territory. Who knows but what beauty is concord of vibrating force-modalities and that the beauty-sense is based on a purely physical relation of different forms of ethereal vibrations? Richard Wagner looked upon perverted taste, imperfect taste or absence of taste as an evidence of disease, or rather as an evidence of a lower standard of health. The vibratory character of all force-manifestation (color, sound, heat, and the corresponding nerve-force-modalities which give a subjective reality to an objective potentiality—"Kraftumwerthung") seems to give a physical basis to speculations of this kind. In regard to the effect of sound on the nervous system the evidence of physical reaction is unquestioned. Sound in its composite and perfected form (music) is undoubtedly an agent that is capable of affecting the potential energies of nerve-molecules and cause the latter to arrange themselves in a state of more or less close aggregation (stimulation, sedation). Organisms that are not affected by these different force-modalities are certainly not normal, *i. e.* not in a state of perfect health. The lesion or defect is somewhere in the finest and most highly organized force-centers. It is the capability of undulations of light and sound reacting upon certain nerve-cells that has given us the therapy of color and music. Both light and sound are capable of affecting (establishing, changing, disturbing) the relation of the organism to its surroundings. Health has been defined: "A condition of perfect relation of the body to its surroundings." If this be health, both color and music must be powerful therapeutic agents. The therapy of color (Chromo-therapy) will be referred to

under the head of Photo-therapy. Music offers a wide field for therapeutic experiment. It is distinctly a nerve-tonic, a nerve-restorer. Reference to this subject in medical journals and books has always been made in a more or less jocular manner. This is unfortunate. In this age of nerve-exhausting activity music has become and is a social-economic necessity. It is a therapeutic agent like rest and physiological exercise. Considerable experimentation along this line has convinced me that music will bring about physiological and therapeutic effects which no other agent or agents are capable of producing. The music-sense (capability of reacting upon sound-undulations) is normally present in every organism. Its absence (Lombroso, Wagner, Nordau) is a sign of degeneration. Shakespeare foreshadowed this truth in his characteristic manner :

"The man who hath no music in his soul,
And is not moved by concord of sweet sounds,
Is fit for treasons, stratagems, and spoils :—
Let no such man be trusted!"

The hygienic importance of light and sound should teach us to avail ourselves of their capabilities in shaping the environments of our patients, whose lives can be made happier and whose physical tone can be improved by the gently invigorating and preserving power of these physical agents. In view of all that has been said we are prepared to agree with Wagner, who declared that artistic culture is a part of personal and public hygiene.

A discussion of personal hygiene as a therapeutic agent would be incomplete without reference to that most active, most powerful and universally present agent for good or evil, the *sexual instinct*. No other force or impulse can compare with it in shaping the destinies of men and nations, the objections of prudes and religious sentimentalists notwithstanding. Religion, patriotism and all the other agencies that sway and move the human heart dwindle into in-

significance if compared to the sexual instinct. The craving for food is the only force that can be said to be equal to the power of the sex-instinct. Hunger is the tendency towards self-preservation on the part of the individual. The sexual instinct is the tendency toward self-preservation on the part of the species. If it were not for hunger and love, the human family would soon cease to exist. Says Schiller:

“Methinks that while philosophy
Does not the world sustain,
The race of man will live as long
As love and hunger reign.”

Sexual hygiene has been and is the *noli me tangere* of moralists, ministers, educators and physicians. A sense of false modesty, a perverted conception of morality prevents the propagation of knowledge along this most important line. An agent of such gigantic power as the sex-instinct which is ever-active should certainly be regulated according to the physiological laws that control the sex-function. Sexual starvation, sexual overstimulation and sexual perversions are frequently the causes of disease and should be discovered by careful questioning and individualization. There is no subject that requires for its discussion as much common sense, as much freedom from religious or other prejudice and as much exact physiological knowledge, as the subject of sexual hygiene. Prudes, religious cranks and hysterical bluestockings of both sexes forget that men and women are made of flesh and blood and that no amount of reasoning and preaching will remove the most characteristic trait of the animal body, *i. e.* the sexual appetite. To look upon it as an evil that ought to be feared and crushed, is a lamentable mental aberration. To allow it to rule and to ruin is an equally deplorable state of affairs. Sexual hygiene consists in applying the functions of sex in a physiological manner for physiological purposes. As a part of personal hygiene it presupposes good judgment and the power of individualization, as far as the medical adviser is

concerned. His knowledge and his judgment should prompt him to give advice and adapt it to the individual requirements. What the advice should be, depends on a thousand different circumstances. I am satisfied to know that I have directed your thought towards this all-important and much neglected subject. In your diagnostic and therapeutic reasoning the sexual habits of your patient should find proper consideration. In diseases of the nervous system the sexual element not infrequently furnishes the clew to diagnosis and therapy.

In applying the principles of hygiene to any given clinical problem the criterion of judgment should be the natural physical standard of man under relatively primitive conditions. Always go back to first principles. Civilization is not an unalloyed boon. In many respects it has brought about inferior conditions and appreciable deviations from the natural standard. In all cases of disease try to make the habits and environments of the patient conform to the standard established by Nature. Hygiene, after all, is physiology applied to actual conditions for the purpose of preserving health and preventing disease. It is, therefore, the true groundwork and support of physiological therapeutics.

CHAPTER III.
DIETETICS.

"Tell me what you eat and I will tell you what you are."—
HIPPOCRATES.

INASMUCH as the food which we eat and drink is one of the conditions upon which the preservation of health depends, the subject of dietetics is in reality a subdivision of personal hygiene. While it is true that as a purely hygienic measure the food question is of inestimable importance, it rises to the level of a therapeutic subject of vital significance when viewed in connection with the sick human body. Many physicians attribute but little importance to the question of food, as shown by the vagueness of the dietetic instructions given to their patients. "Do not eat anything heavy;" "Confine yourself to light, easily digested food;" "Take liquid food only." These and similar vague directions are given to govern the patient's diet. The doctor who habitually makes statements of this kind could not, if pressed, give an intelligent account of what he means by "heavy food," "light food," etc. The truth of the matter is that the importance of the food-question both in the preservation and in the restoration of health can not be overestimated. In many chronic cases the dietetic directions represent the bone and sinew of scientific treatment. Let me begin our discussion by a short résumé of first principles.

The process of low oxidation or combustion of the body, which is one of the outward evidences of its life, would soon lead to a consumption or a burning up of every vestige of tissue, if Nature had not provided for means of keeping the

combustion a-going. Nature demands the proper kind of fuel to keep the fire from going out, and to keep the organism from being consumed. The fuel is added, the process of combustion goes on undisturbed, material that has been utilized and is no longer available is gotten rid of in the form of waste. Since, however, the stomach is not merely a furnace and since food is not consumed like coal in a furnace, the process of burning and keeping the fire up is a trifle more complex than the burning up of coal in a furnace. The fuel which we utilize in continuing the combustion of the organism is not food unless it is available for taking the place, quantitatively and qualitatively, of substance that has been consumed. This brings us to the physiological definition of *food*, which is *any chemical substance or combination of substances capable of aiding in the preservation of the quantitative and qualitative integrity of the body during the process of physiological consumption or of helping in the keeping up of the slow oxidation which constantly consumes the tissues of the body*. This complex definition embraces the physiological meaning of food and suggests the fundamental classification of foods as tissue-builders and tissue-consumers. The latter and likewise the air we breathe conform to the definition given, and must, therefore, be classified as foods. In a dietetic sense we abstract from all foods except those that enter the organism through the so-called alimentary canal. Thus we get a dietetic definition of our subject and are prepared to say that *food is any physiological tissue-builder or tissue-consumer that enters the organism through any part of the alimentary canal*. Any substance which enters the organism through the circulation and is not a food in the sense indicated, is called a *poison*.

Foods, therefore, must be either tissue-builders or tissue-consumers. If they aid in the preservation of the structure of the body, they are tissue-builders and are called proteids, proteins, albumens, albumines, albuminoids or *nitrogenous foods*. These names are synonymous. Foods may add heat

or force by playing the part of fuel and being consumed. They are called *carbo-hydrates*. The large amount of liquids (*i. e.* water) and of mineral salts which the human body needs is to a large extent contained in the foods mentioned.

Quantitatively *water* is the most important element in the organism because it represents approximately 65 per cent of the body. The body of an adult requires about eighty ounces of water daily. One-third of this quantity enters through the solid foods in the chemical composition of which water represents nearly one-half. In some varieties of fruit, water represents 90 per cent and more. The importance of water as a food can hardly be over-estimated. The blood needs water in order to circulate with ease and carry its life-giving elements to every cell in the body. The cells of the body, as Cohen remarks, are distinctly aquatic in their habits. Water represents the largest bulk of their substance and is in one form or another the element in which they exist. Water represents the bulk of excretion through bowels, kidneys and skin.

The *tissue-builders* (nitrogenous foods) are principally lean meat, eggs, fish, milk, cheese, peas, beans, lentils and gluten of all cereals. This means that these foods, as far as their chemical composition is concerned, contain a larger relative amount of tissue-building elements than of carbo-hydrates and mineral salts.

The *tissue-consumers* (force producers, carbo-hydrates) are mainly fats, starch, sugar, gum and alcohol. The fats are frequently called hydro-carbons.

Many of the foods in daily use really belong to both classes inasmuch as they contain approximately the proper proportion of tissue-building and tissue-consuming elements. Milk, meat, eggs, wheat and oats contain both kinds of food-elements. Ordinarily, the animal-foods are considered tissue-builders (nitrogenous) and vegetables tissue-consumers (carbo-hydrates).

The Digestive Process.

The process of introducing food into the organism for the purposes of digestion, assimilation and nutrition begins in the mouth where the food is macerated by the grinding action of the teeth and slowly moulded into a soft mass by the admixture of the secretion of the parotid, submaxillary, sublingual and buccal (mucous and serous) glands. The secretion of these glands is known as saliva and is an alkaline fluid which has the property of changing starch into sugar at a moderate temperature.

The function of the mouth as an organ of perfect digestion depends upon (1) the condition of the teeth, which are the organs of maceration; (2) the slow moulding of the food into a soft mass, it being necessary to grind slowly in order to macerate thoroughly and allow the fluids of the mouth to permeate the mass perfectly; (3) the good condition of the physiological digestive fluids of the mouth. The latter point refers particularly to cleanliness of the mouth, by which foreign more or less offensive substances are excluded and thus kept from causing a deterioration of the normal mouth-fluids. Keeping the mouth clean is, in more senses than one, a praiseworthy task. The filthy habits of the tobacco-chewer and the equally disgusting ruminations of the female gum-habitué are offensive alike to the æsthetic sense and to the physiological instinct. Both habits are frequently productive of digestive disturbances. The filth (bacterial and otherwise) of an unclean mouth may be carried into the stomach and absorbed into the system. The fact that the digestive action of saliva ceases above and below certain temperatures, proves the harmful effects of very hot and of extremely cold drinks or morsels, *e. g.* the habitual drinking of ice-water. That the continued action of extreme heat or cold is bound to injure the mucous membrane of the mouth, is readily understood.

After a morsel of food has been prepared in the mouth, it passes through the œsophagus into the stomach, where it is acted upon by the so-called gastric juice, which is an acid

secretion containing pepsin, hydrochloric acid and a mild curdling ferment called rennet. The gastric juice acts upon the tissue-builders (lean meat, eggs, milk, cheese, fish, peas, beans and the gluten found in wheat, oats and other cereals) and starts the process of disintegrating fat-cells and changing the fats into fatty acids and glycerines. The gastric juice likewise converts cane-sugar into grape-sugar and in this way prepares it for absorption into the system. Cellulose (the substance out of which the cells are constructed which contain the starch granules) is not digested in the human stomach. It must be broken up by mastication or cooking, otherwise it remains totally indigestible. This holds good in regard to all starchy vegetables and cereals.

Food remains in the stomach from one to six hours, depending on the kind of food, the manner of its preparation, the mixture of different food-substances and the condition of the stomach. Coagulated albumen is hard to digest. In the digestion of meat this is an important point. A piece of raw lean meat, if its fibrous elements are thoroughly broken up by maceration, pounding, scraping or grinding, is easily digested. The longer meat is cooked, especially roasted or fried, the less easily digestible it becomes on account of the coagulating effect of heat on albumen. It becomes harder to digest the more fat meat contains, on account of the limited action of the gastric juice on fat. If lean meat or eggs are fried in fat, they accordingly become harder to digest.

The condition of the stomach determines, to a certain extent, the relative speed of the process of gastric digestion. There may be a dearth or an excess of acid in the gastric juice. The greater the amount of acid, the more rapid the digestion of nitrogenous foods. The stomach may temporarily lack the power of digestion. During its period of activity it requires approximately six times more arterial blood than ordinarily. If the required supply, for some reason or other, is not present, digestion will necessarily be slow. Cerebral hyperemia (mental anxiety, study, etc.)

may draw the blood to the brain away from the stomach and thus weaken the digestive power of the stomach. The general system may not require any food, and through the sympathetic nervous system announce this fact to the stomach. The latter responds by declining to ask for food (physiological anorexia; absence of hunger or appetite, nature's demand for food). The stomach may be the seat of disease and through this fact be unable to digest, especially if afflicted by the manifold varieties of gastric dyspepsia. Sluggish digestion may be due to chemical action of one kind of food upon another variety, *e. g.* the presence in the same stomach of albuminous food (egg) and tannin, a large percentage of which is contained in strong tea. The tannin would precipitate the white of egg and render it totally indigestible.

The change which food undergoes in the stomach is the second act in the process of digestion. Little by little the food is discharged into the small intestines through the pyloric end of the stomach. The peristaltic movements of a stomach after a meal affect the ramifications of the solar plexus posteriorly like gentle stimulating massage. Nerve-energy is assembled in the abdominal nervous system. Tension in all other parts of the nerve-supply of the body is relieved. The organism lapses into a delightful condition of repose. Man is at peace with himself and with all the world. The brain is easy owing to reduced blood-pressure. It enjoys a state of absolute rest, which frequently merges into a condition of actual somnolence. I have never taken the old German adage seriously which tells you that

"After eating you must talk,
Or must take a little walk."

It surely refers to an hour or two after eating, not immediately after the meal. The after-dinner nap is a physiological luxury which is sanctioned by that Providence to whom we bow in deference for being so fearfully and wonderfully made. With some persons the after-dinner nap is a physiological necessity.

The most important part of the digestive process takes place in the small intestines, which represent a tube about twenty feet in length. The part which is known as the duodenum is equal in point of importance to the stomach and is sometimes called the second stomach. The digestive ferments are furnished by the pancreas (dissolution of nitrogenous food elements, splitting up of starch, saponification of fats) and the liver (preparing fats for absorption, rendering the intestinal contents alkaline, preventing fermentation) and numerous small intestinal glands (changing starches into sugar, preventing fermentation). Small projections along the entire intestinal canal, called villi, take up particles of digested food and cause them to be received by the so-called lacteal vessels, which assemble their contents in the receptaculum chyli and the thoracic duct, and finally discharge them into the left subclavian vein. The chyle is lifted upward from the abdominal cavity through the mechanism of breathing, the upward movement of the chyle being facilitated by the valves in the thoracic duct which prevent regurgitation of the fluid. The fluid becomes a part of the blood and is carried to all parts of the body.

The contents of the small intestines diminish constantly, owing to the absorbent action of the villi, and practically represent a mass of residue or waste when they are discharged into the large intestines through the ileo-cæcal valve. In the large intestines no digestion takes place. The residue of food and the admixture of mucus, etc., from the bowel is moulded into fecal matter and finally discharged through the anus in a state of fermentation. Physiologically the large intestines represent an unnecessary encumbrance. Pathologically and etiologically they are of the greatest importance. (See AUTO-INTOXICATION.)

The Hygiene and Ethics of Food.

How often should man eat? Under normal physiological conditions man should eat when he is hungry. In the

normal body hunger is the cry of the system for sustenance. It is impossible to say what, when, how often, how much a man should eat. Civilized man is in many respects the product of unnatural surroundings and conditions, and thus the results achieved by civilization (so-called) frequently present perversions and not logical evolutions of Nature's intentions. Decayed teeth, dyspepsia and constipation are some of the gifts of civilization in a dietetic way. Even the domesticated animals share in these doubtful blessings. The punishments which outraged Nature metes out to man for his deviations from the fixed standard, follow in logical sequence. They are the thousand varieties of disease. In this sense disease is an artificial product which appears as the necessary sequence of given premises.

What should man eat? A type of man which is distinctly the product of modern civilization is the meat-eater *par excellence*, who manages to sustain his organism by means of immense quantities of nitrogenous foods served at the rate of three or four meals per day. Habit has caused this man to crave meat and to imagine that meat alone will satisfy his desire for food. Meat is food to him, everything else is an unimportant side-dish. The liquid elements which his organism needs, are introduced in the form of strong stimulating liquors. That the man with carnivorous instincts should want liquor is not surprising. He fills his stomach with tissue-building elements and naturally craves for stimulants to take the place of the force-producing or heat-furnishing carbo-hydrates. He is constipated because his food leaves but little waste. His circulation is constantly in an uproar, his blood not sufficiently liquefied, his nerve-centers are in a state of continued agitation. As a result, the central organ of circulation is weak. This man is the type of a patient who quickly succumbs to an acute disease like pneumonia. The heart can not stand the strain. The organism which has been sustained by immense quantities of nitrogenous foods, collapses, because the power of appropriating food of such quality and in such quantity has been

weakened. The fever-process destroys the organism which is not accustomed to rapid and intense combustion. The meat-eater can not stand capital surgical operations as readily as the vegetarian. The modern man who practically lives on meat is constantly paving the way for some form of disease or other. He is nervous beyond endurance, like the carnivorous tiger in his cage. His instincts gradually become those of the carnivorous beast. His intellectual powers wane while the instincts of his animal nature inversely increase. He craves liquor to equalize the disproportion between tissue-builders and tissue-consumers. Finally his stomach and bowels succumb to the strain and the endless chain of diseases of the organs of assimilation with their complications and sequelæ begins. The urea-laden renal excretion of the meat-eater undermines the function of the kidneys and chronic nephritis is the result. Skin-diseases of variable type follow in the wake of an excessive meat-diet, not to speak of rheumatism which is the meat-eater's disease *par excellence*.

The champions of a nitrogenous diet point to the magnificent physique of the typical meat-eater, the lion, as an example of beauty and superb strength. The illustration is not well chosen. Aside from the fact that the lion belongs to an entirely different species, he eats a great deal at one time, but this does not happen every day nor every other day. In proportion he eats much less meat than the typical carnivorous man, and exercises the muscles of his body much more. Lions in captivity become lazy and even sickly—for obvious reasons.

The large apes resemble the species of man more than any other group of animals. The apes are vegetarians, very healthy and strong, are long-lived and possessed of fine sensibilities and instincts. In captivity they become sickly, weak, learn to eat meat and appropriate many bad traits characteristic of the human species. Civilized apes usually die of tuberculosis. The influence of civilization and captivity on the human and the simian species is interestingly

shown by Darwin ("Origin of Species") and Brehm ("Thierleben"). The latter tells of a French naturalist in Africa whose party ran short of supplies and was compelled to live on berries, nuts, etc. Not being familiar with some of the varieties of fruit which the country produced, the men allowed themselves to be guided by the instincts of a large ape they had caught and tamed. Whatever the ape ate, they proceeded to eat. Whatever he refused, they did not touch. The ape instinctively avoided poisons and other substances not suitable for eating.

The natural history of the entire animal kingdom testifies to the influence of diet over physical and mental qualities. The finer instincts and evidences of soul-life are apparent in the plant-eater more than in the meat-eater. The dove is the emblem of gentleness, the lamb that of purity. The noblest of all domestic animals, the steadfast friend of man behind the plow and on the field of battle, is a vegetarian, the horse. The horse combines all the excellent traits of character that we are wont to admire: courage, gentleness, fiery temper, generosity, intelligence, strength, endurance and devotion to his master. Another of our domesticated animal-friends, the dog, is brutal and savage when fed to meat (the bull-dog), but represents the highest type of animal-intelligence and keen instincts if he is largely or entirely a vegetarian (the hunting dog). The hawk and the eagle are exclusively carnivora and, accordingly, carnal and cruel in their habits. In point of character and intelligence the herbivorous animals are, throughout the whole animal kingdom, superior to the meat-eaters.

The physical effects of diet among the animals is no less characteristic. The plant-eaters possess marvelous endurance (birds of passage, camels, horses, elephants, hunting-dogs). The meat-eaters are vigorous and can make a wonderful display of strength, but they possess little endurance. The lion engages in a terrific battle, and, after it is over, feasts on the mangled carcass of his adversary and spends his time lazily in his haunts until hunger compels him to seek

another bloody encounter. Endurance is the characteristic physical trait of the vegetarian. The winners in athletic contests where it is a question of endurance (swimming, walking, running, etc.) are usually plant-eaters. The enduring power of the vegetarian is shown in the work done by the Chinese coolies, who are not giants in strength and stature, but apparently never wear out. Who has not marveled at the accomplishments of the little brown men of Japan who are principally rice- and fish-eaters? The world has never seen more admirable traits of mind and heart than those recently displayed by the pagans of Nippon. These are facts too well known to require any further demonstration.

The lesson which the study of animal life teaches us is too plain to be misunderstood. It conveys three dietetic principles which are as firm and unshakable as the Rock of Gibraltar:

1. Modern man eats too much and too often in proportion to his physiological wants;
2. Modern man eats too much meat in proportion to the amount of carbo-hydrates;
3. The treatment of all general diseases and many local troubles must begin with a rational dietetic regime.

I do not wish to be understood as saying that man should abstain from meat entirely. While total abstinence in this respect would certainly improve man physically and morally, and would take away the sting of many an avoidable disease and prolong the life of the average man, it would involve many hardships and inconveniences because it would be at variance with the established order of things. In the large cities it is almost impossible to be a practical physiological dietarian. The average man thinks it is impossible to live and remain well and strong without meat. To disabuse the mind of man of this erroneous impression, would be, in its last consequences, an epoch-making accomplishment in social economy. The belief in the dietetic

necessity of meat is a sample of the ignorance that covers physician and layman alike with its nightly shades.

The meat-habit (overindulgence in meat) does not differ from the opium-habit or any other bad habit. It is a habit, never a physiological necessity. It is perpetuated by a perversion of the sense of taste, not by a physiological demand of the system. The need of tissue-building elements is amply filled by a mixed diet of vegetables (principally) and meat (sparingly). Meat in modest quantity should never be served more than once a day. In cases of constipation it should not be given. It leaves but little waste to engage the peristaltic activity of the large bowel, and, therefore, favors the absorption of toxins from the fermenting residue. Most meat-eating animals, especially in captivity, are constipated. Compare the frantic defecatory efforts of the constipated canine with the pastoral tranquillity of the ruminating bovine during the bountiful act of excretion through the *primæ viæ*.

I could not illustrate the clinical physiology of food better than by a short reference to rheumatism. Rheumatism is a disease of nutrition. Uric acid, which is the form in which the nitrogenous derivatives of food exist when they have nearly reached the last stage of chemical change, is present in excess when nitrogenous foods are taken in undue quantity. When there is deficient oxidation or a lack of exercise, the uric acid is partly retained, gets into the blood- and lymph-circulation and causes the familiar symptoms of rheumatism. The modern treatment consists in giving but little nitrogenous food (*i. e.* give it in a vegetable form), in stimulating excretion and in augmenting oxidation. (See RHEUMATISM.) The same logic prevails in the treatment of many other conditions due to deranged metabolism. Let it be remembered that many vegetables contain the proper physiological proportion of nitrogenous elements. They are capable of preserving the human frame in prime condition with all physical and mental forces at their best, as shown by the example of Sir Isaac Newton, who lived to the

ripe old age of ninety and was a lifelong vegetarian. A vegetable diet stimulates tissue-change because carbo-hydrates are most easily oxidized, prevents the accumulation of redundant fat and waste, keeps the body active and the mind sharp and clear. Shakespeare was a wonderfully keen judge of human nature, even in its physical aspects. The words spoken by Julius Cæsar convey a remarkably correct lesson in dietetics :

“Let me have men about me that are fat ;
Sleek-headed men and such as sleep o’ nights ;
Yond Cassius has a lean and hungry look,
He thinks too much : such men are dangerous.”

Cæsar is not afraid of the well-fed and ponderous meat-eater, but he fears the alertness, the ever-active temperament and never-failing endurance of the wiry Cassius, who is evidently a vegetarian. From a purely physiological standpoint the Friday ordinance of the Catholic Church has much to recommend it. If the ordinance were extended to every second day, beneficent results would most certainly follow. Much good could be done if meat were rigidly excluded from the bill of fare in all penal institutions, as is done in some parts of Germany. This would be a practical application of a physiological principle, *i. e.* that the animal functions are stimulated by nitrogenous foods, while carbo-hydrates preserve the finer instincts and emotions of human nature.

The proper food for a well man is a mixed diet of nitrogenous elements and carbo-hydrates. The proportion should be determined by our knowledge of the fact that nitrogenous elements are contained in many, in fact in all vegetables. When peas, beans, lentils and wheat are consumed in large quantities, meat is not needed to furnish the desirable proportion of nitrogenous food. A small amount of rare lean meat once every day or every other day should be a plentiful sufficiency for any one. People should be taught to look upon raw fruit as being a most important

food. Eggs and milk should occupy a prominent position as food elements. Vegetables (raw or cooked) are supposed to be the dietetic mainstay of the healthy man. Meat should always be given the exceptional position of a dietetic luxury. It is not a dietetic necessity. There is no physiological or other kind of reason why an erroneous notion of this kind should be perpetuated.

Diet as a Therapeutic Agent.

As a therapeutic measure in the treatment of disease, the diet of a patient should receive painstaking attention. Remembering the rôle which food plays in the physiological process of combustion and keeping in mind the sluggish metabolism which represents the *raison d'être* of most chronic diseases (*i. e.* impairment of reparative power), we are prepared to appreciate the therapeutic value of the carbo-hydrates which are immediately concerned in the burning up of the tissues and in the forcing of the change of tissue. In conditions characterized by intensified combustion (febrile, hectic), the importance of nitrogenous feeding is apparent ("feed fevers!" Fothergill). When the organism is losing ground without febrile reaction, the indication for a suitable mixed diet is plain. If the stomach or bowels present certain pathologic evidences of a local character, the chemistry of the food administered should be taken into consideration. Thus, the diet of a patient with a dilated stomach should, for obvious reasons, be suggested by the necessity of preventing fermentation. (See DYSPEPSIA). In a general way we can systematize therapeutic dietetics in the form of four fundamental laws, to wit:

1. Loss of weight without fever calls for a mixed diet;
2. Continued fever is an indication for nitrogenous food;
3. Sluggish metabolism which is typical of most chronic diseases requires carbo-hydrates;
4. In disorders of the stomach or bowels the diet should be regulated by the chemistry and mechanism of the process of digestion with careful individualization.

The first sub-division refers to cases of lowered vitality and general depression that present ill-defined diagnostic features, such as the thousand and one different functional diseases of the nervous system, *e. g.* nervous prostration (unless caused by a dilated stomach), the nervous disorders of the menopause, conditions produced by lack of fresh air and sunshine, etc., etc.

Typhoid fever is a classical example of a continued fever. A continuous low fever, *e. g.* in tuberculosis, should dietetically be met by tissue-builders. In all these cases combustion is accelerated and intensified, and, for this reason, carbo-hydrates in excess are not indicated.

Wherever and whenever oxidation is sluggish, causing waste-products to be retained in the blood, the lymph-fluids, the bowels, the lungs, etc., etc., the diet should mainly consist of carbo-hydrates and foods that are largely aqueous. This should be the rule in all diseases of general and local nutrition, *e. g.* rheumatism, skin-diseases.

In cases of dilated stomach all articles of food that are fermentable should be withheld. The generation and accumulation of gas would dilate the stomach still more. In cases of over-acidity, nitrogenous foods would be easily digested. For mechanical reasons solid foods would be contra-indicated in gastric ulcer, intestinal ulcerations (typhoid fever), etc.

The dietetic position of different foods is indicated by the following list, which shows at a glance the salient points of therapeutic interest in regard to the more common foods in daily use. The foods in common use, in the order of their nitrogenous food-value, are cheese (33 to 43 p. c.), beans (25 p. c.), lentils (25 p. c.), mushrooms (24 p. c.), ham (24 p. c.), peas (23 p. c.), spring-chicken (23 p. c.), lean beef (22 p. c.), duck (21 p. c.), lean pork (20 p. c.), veal (19 p. c.), pigeon (19 p. c.), salted herring (19 p. c.), medium beef (18 p. c.), game (18 p. c.), chicken (18 p. c.), meat-sausage (18 p. c. and less), oatmeal (16 p. c.), lamb (15 p. c.), fat pork (14 p. c.), corn (14 p. c.), eggs (12

p. c.), wheat (11 p. c.), fish (10 p. c. and less), noodles (9 p. c.), rice (7 p. c.), rye (6 p. c.), oysters (6 p. c.), cream (5 p. c.), milk (4 p. c.), potatoes, spinach and cabbage (2 p. c.).

Foods in common use, in the order of their carbohydrate value, are beets and carrots (95 p. c.), rice (77 p. c.), noodles (77 p. c.), wheat (73 p. c.), corn (71 p. c.), honey (70 p. c.), oatmeal (64 p. c.), peas (57 p. c.), beans (56 p. c.), lentils (55 p. c.), mushrooms and wheat (51 p. c.), rye (48 p. c.), potatoes (21 p. c.), cherries (15 p. c.), apples and pears (12 p. c.), plums (8 p. c.), spinach and string beans (6 p. c.), strawberries (6 p. c.) cabbage (5 p. c. and less).

Foods in common use, in the order of their fat-contents, are butter (85 p. c.), bacon (79 p. c.), fat pork (47 p. c.), meat-sausage (40 p. c. and less), ham (37 p. c.), cream (29 p. c.), cheese (25 p. c. and less), salted herring (17 p. c.), beef (10 p. c. and less), lamb (9 p. c.), veal (8 p. c.), oatmeal (6 p. c.).

Foods in common use, in the order of the quantity of water they contain, are cabbage, watermelons, cow's-milk (93 to 88 p. c.), strawberries, pears, apples, potatoes, cherries (88 to 75 p. c.), lean beef, lamb, lean pork, chicken, pigeon, game, duck, eggs (75 to 70 p. c.), cheese, fat pork, salted herring, wheat, rye (48 to 42 p. c.), ham (28 p. c.), mushrooms (17 p. c.), cereals (15 to 10 p. c.), butter, bacon (10 p. c.).

All foods mentioned contain a small admixture in variable proportion (average 5 p. c.) of mineral salts and waste.

It will be noticed that beans, lentils, peas and mushrooms head the list of nitrogenous foods, and that there is only one variety of meat (spring-chicken) that comes near these vegetables in tissue-building value. Cheese is the best nitrogenous food. The large percentage of carbohydrates which beans, peas, lentils and mushrooms contain, give them a singular fitness as parts of a mixed diet. From a purely nutritional point of view they surpass any and all other foods.

The nitrogenous foods form the blood, the organs and tissues of the body. The fats are either deposited as such in the system or are burnt up (oxidized) through the action of the oxygen in the body, leaving waste or ashes behind in the form of water and carbonic acid. The carbo-hydrates are the real fuel. They burn up and, in so doing, produce force and heat. The relative amount of nitrogenous matter in the body is not influenced by work or muscular exertion. Exertion means more oxygen, more fuel, more intense combustion and, therefore, more carbo-hydrates. A working man of medium stature needs daily about 2,818 grams of water, 100 grams of digestible albumen, 55 grams of fat, 500 grams of carbo-hydrates, 32 grams of mineral salts, and 744 grams of atmospheric oxygen. Food represents latent energy. To express the energy stored in a certain quantity of food, the energy is measured in units, called *calories*. A calorie is the amount of heat required to raise one gram of water 1° C. Approximately one gram of dried nitrogenous food represents 4,000 calories, the same quantity of carbo-hydrates 4,200 calories, the same amount of fat 9,500 calories. Adding the number of calories to the amount of nitrogenous or proteid units (building material), we obtain the actual physiological value of the food estimated. Knowing the physiological requirements of the body as expressed in calories and nitrogenous units, and knowing the number of calories and nitrogenous units contained in any given food, we are able to estimate the food required by a body of given size and doing a certain amount of work.

The length of time which is consumed in the digestion of special foods is an item of some importance. The following list indicates approximately in what space of time the digestion of different foods under ordinary circumstances may be considered complete.

In one hour. Cooked rice. Boiled pigs feet. Tripe.

In one hour and thirty minutes. Beaten raw eggs. Boiled trout. Barley-soup. Sweet soft apples. Roasted game. Parsnips. Calf's brains.

In one hour and forty-five minutes. Cooked brain. Sago.

In two hours. Tapioca. Barley. Milk (boiled). Fried beef-liver. Raw eggs. Sour soft apples. Sour cabbage. Raw milk. Codfish. Bouillon.

In two hours and fifteen minutes. Fried eggs. Cooked turkey.

In two hours and thirty minutes. Cooked gelatine. Raw beef chopped. Roasted turkey. Wild-goose roast. Shoat. Spring lamb. Cooked beans. Sponge-cake. Fried potatoes. Cabbage. Cooked marrow. Sweet-bread.

In two hours and forty-five minutes. Chicken fricassee. Omelette. Milk pudding. Cooked beef. Sour hard raw apples. Raw oysters.

In three hours. Soft-boiled eggs. Fried bass. Lean beef, medium. Fried steak. Pickled pork. Roasted lamb. Pickled pork stewed. Boiled lamb. Chicken-soup. Bean-soup. Apple dumplings. Corn cakes (baked). Fried pork-chops.

In three hours and thirty minutes. Fried oysters. Pickled pork fried. Pickled lamb. Corn-bread. Carrots (boiled). Pork-sausage fried. Brown butter. Oyster-soup. Lean beef fried. Beef boiled in mustard. Melted butter. Old cheese. Lamb-soup. Fresh-baked wheat-bread. Turnips boiled. Boiled potatoes. Hard-boiled eggs. Succotash. Boiled beets. Raw ham. Caviar. Herring. Smoked tongue.

In four hours. Pickled salmon boiled. Pickled beef stewed. Fried veal. Fried chicken. Chicken-stew. Fried duck. Vegetable beef-soup. Beef-heart fried. Bacon.

In four hours and thirty minutes. Pickled dried-beef boiled. Pickled pork fried. Marrow-soup. Pickled pork boiled. Veal pot-roast. Lamb-suet boiled. Boiled cabbage.

In five hours. Fried pork. Beef-suet boiled.

In logical sequence I ought to discuss the preparation of foods, for hygienic cooking is a subdivision and an integral part of dietetics. It does not, however, concern the physi-

cian directly. In connection with the preparation of foods we must bear in mind that the civilized man of to-day is not by any means the ideal or normal man. The finely cultivated sensibilities of the former are perversions of the original natural instincts of the latter. The olfactory as well as the gustatory sense does not respond to the natural stimuli, but requires new and strong sensations. This is strikingly the case in regard to the foods we eat and drink and to the manner of serving them. That the normal man can live on and is amply satisfied with the food which nature offers directly (water, milk, raw fruit and vegetables), there is no doubt. The raw-food fad which recently engaged the attention of Eastern society, proved that even the civilized stomach does very well with raw food. The remarkable cure of not a few dyspeptics by the raw-food diet, is worthy of passing notice. The educated sense of taste and the refined sense of smell resists food of this kind because, through habit, appetite for and relish of food depend largely upon the impressions which are made upon the senses of taste and smell. Thus the art of cooking originated by which the palate, the nose and the stomach can be stimulated, pleased and satisfied in a thousand different ways. To please a slowly degenerating sense of taste became the task of the cook, whose resourcefulness and artful devices have made him an important factor in the affairs of the human family. If Napoleon's cook had been able to please the stomach of the grim Corsican in its never-ending whims and caprices, he would have influenced the trend of history in no uncertain manner. I have referred to the sense of taste of the modern man as an instance of perversion or degeneration. Nature punishes digressions from the normal standard by inflicting the offender with disease. Diseases of the stomach are more common than any other. The reason is that the stomach is sinned against oftener than any other part or organ of the body. People sin against their stomachs in six different ways, to wit: 1. They eat and drink too much; 2. They eat too large a proportion of nitrogenous food; 3.

Food is not prepared properly; 4. The stomach is subjected to too much violent stimulation; 5. The stomach is exposed to too many thermic shocks; 6. Alcohol and other irritating stimulants are used at the wrong time and in too large quantities. In the treatment of all gastric disorders these six points serve a good diagnostic and therapeutic purpose.

The first three points have already been touched upon. The fourth point refers to the use of spices and condiments. The latter are added to foods in order to please the palate or the olfactories. Taken in excess these spices and condiments can not help but be productive of harm. (See SKIN-DISEASES.) A sense of taste that always craves for highly seasoned food and an excess of salt, pepper, mustard, etc., is not normal. Inflammatory or catarrhal reaction of the gastric mucous membrane is bound to follow. The craving for liquor usually coexists. The use of spices and condiments at all times and in all foods is certainly the specific cause in not a few cases of stomach-trouble. The presence of sharp and irritating substances in the stomach can not help but impair the mucous membrane. The tannin and the alkaloids contained in coffee and tea are objectionable for similar reasons, if the two beverages mentioned are partaken of in large quantities and in largely concentrated form. Much of what has been said concerning the use of stimulants holds good in regard to tobacco. Tobacco in moderate quantity is hygienically not objectionable in any form, although the chewing habit is hardly an indicator of personal cleanliness. If used constantly, tobacco becomes a poison, capable of destroying the functional integrity of the heart and of the nervous system.

Thermic shocks are thought by many to be the most fruitful source of stomach-trouble. The sudden chilling of the gastric mucous membrane by cold drinks (ice-water, very cold beer, ice-cream), especially when the stomach is relatively empty, is certainly not calculated to improve its physical condition. Ice-water is by virtue of its temperature a pathogenic element that must be reckoned with. It is

distinctly an American product and its use a distinctly American form of idiocy. Dumb brutes have never been known to be guilty of the follies which man (*homo sapiens*) constantly commits. While fresh, pure drinking-water is a necessity and a luxury, its temperature should be in keeping with the tolerance of the body. The effect of an ice-cold drink on the unprotected surface of an empty stomach is bound to shock the nerve-supply of the stomach. It contracts the blood-vessels of the gastric mucous membrane and induces a reaction which leaves the membrane congested and irritated. It must be remembered that the temperature of the water has nothing whatever to do with its fitness to quench thirst. An equal amount of warm or hot water would serve this purpose as well as ice-water. Cold water pleases the palate. The moment a sufficient amount of fluid has been taken up by the system to supply the physiological demand, thirst ceases.

The use of alcohol at the wrong time and in the wrong way is a prolific source of stomach-disorder. An alcoholic drink on an empty stomach is not proper. The "eye-opener," from the standpoint of health, is to be condemned. It is an irritant to the mucous membrane and can not be indulged in habitually without harm ensuing. The prevalence of whisky-drinking in this country is a fact much to be deplored. Whisky is a medicinal stimulant, never a beverage. P'ettenkofer considers whisky-drinking on a par with cocaine-eating. It is the abuse of a splendid food (alcohol). He suggests the substitution of beverages that are wholesome, nutritious and contain alcohol in comparatively small quantities, *e. g.* very light wines and, above all, the popularization of good beer. Therein lies the practical solution of the temperance-problem. Whisky-drinkers are usually drunkards, beer-drinkers hardly ever. Even in large quantities beer affects the stomach mainly through its bulk. On a full stomach—*ceteris paribus*—a mild stimulating beverage (light wine or good beer) is, as Sturm remarks, a veritable gift of the gods. It aids digestion and promotes metabol-

ism. Strong alcoholic drinks (over 6 p. c. of alcohol) retard and finally check digestion. They precipitate the pepsin of the gastric juice and coagulate the food-albumen, rendering the latter less soluble. The digestive power of the pancreatic secretion is affected by small quantities of alcohol: One ounce of brandy delays the digestion of a meal for a half-hour to an hour.

That food is bound to influence the progress of disease and must, therefore, be of great consequence therapeutically, is readily seen when we consider its importance during health. Our discussion of the chemistry of foods has taught us that food affects metabolism directly, and, therefore, is capable of striking at the very foundation of physical life. In chronic diseases which are not characterized by a distinct waste or a continuous loss of weight, oxidation is sluggish and imperfect. The general symptoms in these conditions are caused by the retention of waste-products or, as Rouchard says, by auto-intoxication. (See FUNCTIONAL DISORDERS.) The therapeutic importance of the carbohydrates in these conditions is plain. Try to conceive the physical life of the sick person as a physiological problem. The dietetic features of the treatment will suggest themselves as necessary conclusions of your reasoning. Remember that 75 p. c. of all chronic diseases are primarily due to disorders of the organs of digestion. The results in practice justify the hyperbole which seems to be contained in this statement. At any rate, you will never have cause to regret the prominence which you give to the stomach in your therapeutic reasoning. Dietetic knowledge compensates for lack of diagnostic or therapeutic skill in not a few instances.

The perversions which modern civilization has wrought in the ideas and instincts of man have affected his stomach and its habits. In view of this fact a return to the naturalness and simplicity of normal man seems imperative. Knowledge of physiology should be a part of the inner consciousness of a physician. It should precede diagnosis and

therapy. The dumb animals practice dietetic philosophy instinctively. They do not deviate from the natural standard as long as man does not coerce them. Then they, too, degenerate and lose their fitness to survive in specific perfection. It seems to be only too true that "civilization is the biggest lie that has ever been told in one word" (Nordau). It has improved man in accidentals, but impaired him in essentials. Queen Catharine in speaking about Wolsey, said that he was "a man of an unbounded stomach." This is a good description of modern man and a short but significant résumé of the etiology of most chronic diseases.

CHAPTER IV.

THE PHYSIOLOGICAL EFFECTS OF HEAT AND COLD.

THE increased interest which physicians are taking in the theory and practice of hydro-therapeutics¹ is—from a therapeutic point of view—a characteristic sign of the times. It is not so very long ago since the average physician would decline to even for one moment seriously discuss hydro-therapy as a legitimate method of medical treatment. Fifty years ago the French Academy of Medicine gave it as its opinion that hydro-therapy was a dangerous form of experiment. Even nowadays the scientific hydro-therapist is hardly given a hearing unless it be by the progressive men in the profession, who, unfortunately, do not constitute the majority. Hydro-therapy has fought a long and bitter battle and owes its recognition by the progressive men in the profession to its own intrinsic, scientific value, to its wide range of applicability, and to its truly wonderful clinical efficacy. The prejudice against water-applications is due to several distinct factors. Up to within a comparatively recent period, the exponents of practical hydro-therapy were uneducated empirics, who enshrouded themselves and their work in a great deal of mystery to impress the credulous and ignorant. In this way the method came into disrepute

¹*Hydro-therapy* includes the therapeutic uses of heat and cold if these agents are applied by means of water. *Thermo-therapy* refers to the therapeutic uses of elevated temperatures (heat) irrespective of the carrier which is used. Its meaning is limited to the effects of *heat*. I have confined the discussion of the physiology of heat and cold to hydro-therapy because the latter is the classical exponent of the whole subject and—physiologically and clinically—more important than any other method of applying heat and cold.

through the men who were identified with it and through the manner in which it was applied. The prejudice which in this way was engendered against the method among the practitioners of medicine became more and more established, there being but little effort made by physicians to inform themselves concerning the method which they were condemning. In addition to this the successful application of hydro-therapy presupposes an exact physiological knowledge and familiarity with pathological processes not essential in the administration of drugs and in the application of drug-methods. Another reason why hydro-therapy has as yet failed to find a place in the clinical armamentarium of most physicians is the fact of its being necessarily encumbered with an amount of technical detail, taking up time and labor of both physician and patient. For all these reasons hydro-therapy has as yet not conquered the place which it so richly deserves. Some physicians are inclined to look upon it as a fad, an ephemeral innovation which will be relegated to oblivion whenever the charm of novelty is worn off or whenever some later fad commands professional attention. Few seem to know that hydro-therapy is among the oldest, if not the oldest clinical method known. To readers of Latin the grateful appreciation expressed by Horace concerning the splendid work of Musa, who had cured a number of prominent Roman bon-vivants of gout and similar afflictions simply by water applications, is familiar. Long before the golden age of the Roman Empire water as a therapeutic agent was held in high esteem in Greece and Egypt, according to the statement made by Herodotus. The Romans were famous for the grandeur and luxury of their baths, where various hydro-therapy procedures were constantly *en vogue* for the treatment of different ailments. During the Middle Ages the hydro-therapists of Italy and France enjoyed a vast reputation. One of the greatest medical men of the sixteenth century, Ambroise Paré, was an enthusiastic admirer of water applications. With the approach of the nineteenth century hydro-therapy was grad-

ually usurped by empirics and charlatans, who, by the indiscriminate use of powerful hydro-therapeutic methods and by the bitterness and persistency with which they antagonized all other therapeutic measures and scientific medicine generally, brought the whole subject of hydro-therapy into disfavor with the profession at large. Yet it can not be gainsaid that some of the empirics, notably Priessnitz,² contributed very largely to the elaboration of the subject of hydro-therapy, especially as far as the clinical uses of the various methods and the improvement of technical resources were concerned. Practically, the renaissance of hydro-therapy within the confines of legitimate medicine was consummated by the introduction of the cold-water treatment of typhoid fever. Since that time increased interest in the subject has been manifested among the progressive members of the profession. Numerous books, especially Winternitz's great work, attest to the earnestness with which the subject is received by some of the brightest medical intellects of the day. The number of strictly scientific hospitals and sanitariums devoted to hydro-therapy is increasing from year to year. Hydro-therapy has achieved its greatest triumphs in the very home of scientific thought, Germany, where already at a number of universities special chairs for the theoretical and clinical teaching of hydro-therapy have been established. It remains to be seen which American institution will be progressive enough to admit hydro-therapy into its curriculum of studies as an independent and recognized branch of medicine. Verily, by virtue of its physiological exactness and clinical usefulness, hydro-therapy is entitled to a prouder and more dignified place among the various departments of medical teaching.

²It is true that Vincenz Priessnitz was not an educated physician, but he was a medical genius, who instinctively felt what many, after years of study, do not grasp. A doctor of medicine is not necessarily a physician.

The Physiology of Water Applications.

Water as a therapeutic agent is employed both externally and internally. The science of hydro-therapy, however, deals principally with its external use, *i. e.* the various methods of applying it to the skin. I shall, therefore, confine myself to the discussion of the physiological principles underlying the diverse methods of employing water externally and the effects aimed at. Water in and of itself is not a therapeutic agent, to which could be attributed certain remedial potencies. It serves, however, as a carrier of certain physical forces and properties which are capable of producing characteristic and profound physiological effects upon the system through the instrumentality of that most delicate and responsive of finely organized structures, namely the skin. There are other agents, which possess in a measure the same physical properties. From a practical point of view, however, water is by far the most available of all these agents, since it is inexpensive, easily obtained, and can be utilized in any number of ways and forms. Thus, as a carrier of temperature, air might be utilized as effectively as water, but the manner of making it subservient to our purpose and the method of handling it entails much technical difficulty. Experience has shown water to be the most available of agents to serve as a carrier of heat and cold. This fact furnishes the practical basis for hydro-therapy. The logic of hydro-therapy, then, becomes apparent if we analyze the physiological effects of heat and cold primarily upon the skin, and secondarily upon the system at large.

The idea of temperature is intimately bound up in and inseparable from all vital processes. All organic beings are affected by different degrees of heat and cold. The outward manifestations of life in every organism and in every part of an organism are dependent upon the degree of temperature by which the organism, wholly or in part, is surrounded. The manifestations of life are retarded or accelerated or entirely suspended by the variations of temperature. This holds good in regard to the most perfectly organized bodies

as well as to the simplest forms of organic life. Ciliary motion, ameboid movement, the vesicular contractions of the infusoria, the contractions of muscular fibers, etc., etc., all react upon thermic influences. Ordinary degrees of heat and cold respectively accelerate or retard motion, while extreme degrees completely arrest it, and, if continued, endanger the vitality of the organic body. Inasmuch as the motor function of cellular bodies is affected by heat or cold, this effect is not characteristic of the action of heat or cold alone. Any irritant, *e. g.* contact with another body, is sufficient to affect the movements of the organism for the time being. Heat or cold, therefore, primarily act as irritants or excitants pure and simple. The study of physiological processes within the animal economy of warm-blooded animals has taught us that these processes are necessarily dependent upon a certain degree of heat. Heat makes possible and accompanies the conversion of chemical elements into the forces and functions which constitute the life of the organism. Furthermore, we know that heat is the principal product of the metamorphic and functional activity which takes place within the animal economy. In the present state of our knowledge we can assume with a reasonable degree of certainty that heat and function, meaning by the latter the sum-total of force-manifestation within the organism, are dependent upon each other, are convertible into each other; that organic life, therefore, is a condition produced by a heatmaking process within the organism. We can deduct, furthermore, that function and heat-production are in direct proportion to each other. If we intensify the one, we *ipso facto* increase the other; if we depress the one, diminution of the other must necessarily follow. Since the functional activity of the organism, however, either is concerned in the taking-up of food (nutrition in its wide physiological sense) or in the expulsion of waste (excretion), it stands to reason that the degree of nutritive and excretive function is in direct proportion to the degree of heat present. A low degree of temperature means slow oxidation,

retarded tissue-metamorphosis, and, therefore, slow nutrition and lessened function. This holds good in regard to the whole organism as well as to each and every part individually. These physiological considerations enable us to draw a conclusion of momentous importance: If we can control (intensify or depress at will) the heat-producing process, then we can regulate oxidation, functional activity, nutrition and tissue-change. These strictly physiological premises embolden us to go even further in our conclusions. If we can accelerate or retard the chemico-physiological activity in the organism at large, or locally in any of the organs of the body, then we certainly have snatched from the hands of Nature the magic wand which holds at bay the enemies of our bodies, which preserves our physical well-being during the onslaught of disease-producing germs and elements, which sustains our body in its integrity, and which enables the fittest to survive. That magic wand is FEVER. Fever is, as we at this late day are ready to admit, accelerated oxidation of the tissues of the organism, hastened nutrition. All the engines of the organism are working at full speed, large aggregations of slack and waste are hurled through the gateways of excretion, new food-material is devoured and consumed by the roaring furnace within. Finally the organism returns to its normal speed and amount of work, the vicious elements of disease have been eliminated, regeneration has taken place, health again supervenes. That such a process of rapid oxidation (fever) should be accompanied by an increased amount of heat (elevated temperature) is but natural to assume in view of the previously quoted physiological laws governing the vital processes within the organism. That we can radically modify the processes of heat-production and by so doing necessarily affect oxidation and nutrition, that we can, consequently, arbitrarily bring about a fever-process even to the extent of causing local or general temperature to rise and fall, is an undisputed fact, and can be abundantly demonstrated by experiment.

The purely physical effect of heat and cold upon tissue of all kinds, both dead and living, is expansion and contraction. The molecular elements of the tissues respond to the exciting cause and arrange themselves, as a result, at greater or less distance from each other, the intensity of the effect being in proportion to the difference between the temperature of the tissue acted upon and the temperature acting upon it. The more marked the contrast between the two temperatures, the greater the effect of contraction and expansion. The immediate result of this purely physical phenomenon is the production of a dynamic element, a force, resembling in its manifestations an electrical or magnetic potency, which, as all physicists know, springs into existence whenever temperatures of different degrees come into contact and which travels in the direction of the lower temperature. If the substance acted upon is a living organism, the electrical potency generated will travel along the paths of the inherent vital energies or currents of nerve-force with which, as DuRoi's Raymond has shown, all living tissue is constantly charged. Thus, heat and cold are capable of affecting the amount and power of the currents of nerve-force circulating in our nerve-fibers, and through the brain and spinal cord make impressions upon the whole (motor and sensory) nervous system (Winternitz).

Whenever water the temperature of which is higher or lower than that of the body-surface comes into contact with the skin, this contact is perceived by the cutaneous nerves as a sensation of heat or cold. The capability of the skin-nerves to perceive heat and cold is called the "thermic sense," and manifests itself within certain degrees of temperature below which and above which the impressions are merely those of pain. Extreme heat and extreme cold resemble all other nerve-stimuli or nerve-excitants inasmuch as they impair or even completely suspend the nerve-potency of receiving and conducting sensations. A state of temporary anæsthesia is produced. A high but not excessively high temperature of short duration, likewise a low but not

excessively low temperature of short duration, intensifies the susceptibility of the skin for tactile impressions, *i. e.* the skin becomes hyperæsthetic. If the application is of longer duration, tactile impressions become more and more faint, —anæsthesia of the skin supervenes. Hence we speak of overstimulation and subsequent exhaustion of the functional power of the cutaneous sensory nerves. In connection with this subject it is of interest to note that not a few physiologists, among them Blix, Goldscheider and Herzen, recognize the thermic sense as being bound up in certain fine nerve-endings entirely distinct from the end-bulbs commonly credited with receiving tactile impressions. Some of them, notably Blix, whose ingenious experiments were made in the physiological laboratory of old Upsala, recognize two distinct thermic senses (one of heat, one of cold), with separate terminal structures and independent central connections. All these authors, however, agree and numerous physiological and clinical experiments go to show that heat and cold applied to the skin are capable of affecting (in- and de-creasing) and altering the innervation of the organism wholly or in part. In connection with this subject it may be of interest to call attention to the statements made by Krebs and Heimann in explanation of the sedative action of complete immersion of the body in warm water. That aqueous elements do enter through the skin (endosmosis) has been demonstrated. It is claimed that in this way an edematous condition of the peripheral nerve-endings is produced, causing the molecules within these endings to move sluggishly. Nerve-impulses are received and carried with less promptness and a state of comparative quietude of the nervous system is brought about.

These purely thermic effects on the skin-nerves, and through these on the nervous system, are immediately followed by, and can not practically be separated from, characteristic effects on certain vital processes within the organism which are wholly or largely controlled by the nervous system. These vital processes go to make up the two

fundamental functions performed by the machinery of the body, *i. e. nutrition* (self-preservation of the organism) and *excretion* (expulsion of waste). Inasmuch as nutrition of a part is dependent upon the blood-supply of the part, we are ready to admit that to control the blood-supply means to regulate nutrition. Furthermore, since the degree of functional activity of any organ is in direct proportion to the amount of arterial blood and *vice versa*, we are prepared to say that, if we can control the blood-supply of the organs of excretion, we can regulate excretion. To control nutrition and excretion by regulating the blood-circulation means to control the very processes by which the life of the organism is preserved. That these statements do not contain visionary notions, but strictly scientific truths which can be verified by clinical demonstration, the following physiological considerations will serve to show.

A thermic stimulus perceived by the cutaneous nerves is communicated to nerve-centers situated in the brain, cord and in the peripheral ganglia. Through these the stimulus is reflected to the vaso-motor nerves of the area which received the thermic impression originally. In this way the circular muscular fibers of the arterial walls are made to contract or relax, as the case may be. In addition to this reflex process the application of heat or cold to the skin has a purely physical effect, consisting in the contraction or expansion of the contractile tissues of the skin, especially the muscular fibers. Hence, there necessarily takes place a contraction or dilatation of the skin-capillaries independently of any reflex mechanism. This is shown by applying heat or cold to the skin after the nerve-supply has been rendered inert (*e. g.* by severing the nerve-fibers supplying the region). Thus, the phenomenon known as *cutis anserina* (goose-skin) is produced by purely local action of cold. The non-striped muscular fibers of the skin and of the arterial coats violently contract, forcing the blood out of the skin. The skin looks anemic, sunken and wrinkled, causing the skin-papillæ to appear more prominent than at other

times. Gradually the muscular contraction passes off and normal conditions are re-established. The contracted vessels are gradually filled with blood, which rebounds into them with renewed vigor. The temporary contraction is followed by a temporary dilatation, anemia by hyperemia. The circular fibers of the arterial walls relax beyond their normal size, the process resembling the backward-swinging of a pendulum, which does not stop at the central point, but swings beyond it. This peculiar conduct of the arterial walls causing a hyperemic condition to follow an anemic state produced by cold, is the essence of what hydro-therapists call *REACTION*, and is the pivotal point upon which the science of hydro-therapy revolves. If a certain area of skin is rendered anemic by the action of cold, the blood is forced into the vessels whence the blood-supply of that particular area of skin comes (tributary circulation). Induced anemia of the skin is, therefore, necessarily associated with hyperemia of those parts into which the blood of the skin-vessels has been forced. When the action of cold ceases, *reaction* begins. The hyperemic parts unload their surplus of blood and the conditions are reversed: the subcutaneous tissues become comparatively anemic while the vessels of the skin are replete with blood. The intensity of reaction depends upon the suddenness with which the cutaneous vessels are contracted, and upon the extent of the area within which anemia is produced. If the reaction involves a large area, the anemia or depletion accompanying it may affect deep and important structures at some distance from the hyperemic area. Thus, it has been practically demonstrated that forcible reaction involving the blood-supply of the abdominal wall will affect the vessels of the meninges. Schueller trephined rabbits and through the opening made exposed a circumscribed area of the meninges. Whenever a *cold-water* application was made to the abdomen of the animal, *dilatation* of the vessels of the pia mater was distinctly noticeable. A *warm-water* application to the abdomen was followed by *contraction* of the meningeal vessels. Immer-

sion of the animal in cold water was promptly followed by wide dilatation of the meningeal vessels, immersion in hot water caused forcible contraction. Reaction involving the surface of the extremities and the trunk (*e. g.* during a complete pack) will almost deplete the encephalic circulation, as is shown by the somnolence of the patient during the pack.

The physiological manner in which reaction takes place is still a matter of speculation. Some seem to think that the effect (arterial contraction) passes off the moment the cause (application of cold) ceases to act. "*Cessante causa tollitur effectus.*" Others say that the forcible contraction of the muscular coat of the artery temporarily exhausts the tone of the vessel-wall and necessarily leads to a condition of relaxation and fatigue. According to Winternitz, however, reaction is a more complex process. He states that the thermic impulse excites the vasomotors and thus produces contraction of the artery. Gradually the functional potency of the vasomotors is exhausted, exciting the inhibitory nerves of the vessels to action, thus producing vascular relaxation.

What are the necessary and possible physiological results of reaction as far as nutrition generally and locally is concerned? In considering this question, we must distinguish between the area to which the thermic stimulus is applied (primary area) and the area which is rendered anemic by the resulting reaction (secondary area). Thus, if we apply a cold, moist pack (Priessnitz method) to the skin of the lower extremities, the surface packed would be the primary area. When reaction sets in, the primary area becomes actively congested, *i. e.* the lower extremities become replete with blood. It stands to reason that as the blood-supply in the primary area increases, some other part or parts of the body must *lose* some of its or their blood in order to make an over-supply in the primary area possible. The part which yields some of its blood-supply is as it were the tributary territory. It is what I have previously designated as the secondary area. The necessary effect of a reaction in the primary area is a partial depletion in the secondary

area. This is a simple mechanical problem. To the mind of the intelligent practitioner there is contained in it a wealth of therapeutic suggestion. If the secondary area is the seat of a pathological (active or passive) hyperemia, it is plain that partial depletion of the congested part means lessening of the hyperemia existing there. An inflammation would necessarily be aborted thereby because the inflammatory process would be deprived of its working capital. The congested area is partly depleted and thus deprived of the essential elements of inflammation.³ If we apply the therapeutic indications of Schueller's experiments clinically in a case, for instance, of simple meningitis, we are clearly conscious of the *modus operandi* of our method. We know that a hydro-therapeutic reaction is the ideal anti-phlogistic. It is venesection without loss of blood. Thus we are in a position to summarize the broad therapeutic availability of reaction by saying that the production of reaction is indicated whenever depletion is desirable. It is—*ceteris paribus*—the scientific remedy for the relief and cure of all inflammatory and congestive conditions. We can conscientiously go even farther and say: it is the prophylactic measure which prevents and aborts inflammation and congestion. Clinically the brilliant statistics of pneumonia

³The hydro-therapeutic "derivating" method is the classical type of a rational antiphlogistic procedure. The principle is practically the same as is contained in Priessnitz's "refrigeration" and Bier's "congestive method." Priessnitz, in the treatment of localized inflammations in the extremities, especially in joints, frequently succeeded in aborting the inflammatory action by continued cold applications *above* the seat of trouble to "cool the blood," and incidentally, by contracting the vessels, to lessen the blood supply. Bier's method consists in applying a constricting bandage above the seat of inflammation, thus causing a condition of stasis below the line of constriction. The inflammation is literally starved out. Even in septic inflammations Bier's method is of service, principally through constriction of the lymphatics and prevention of the absorption of toxins. Bier's "congestive method" is an effective anodyne, the pain-relieving effect being due to the lessening of blood-pressure.

treated hydro-therapeutically fully bear out and confirm these statements. It is plain that *reaction* is the pivot upon which the whole practice of hydro-therapy revolves. Hydro-therapeutic science draws its clinical conclusions and makes its therapeutic applications, not from primary, but from the secondary effects. Between the two effects reaction is interposed as a necessary link in the chain. We are ready to understand the difference between hydro-therapy and the clinical uses of superheated air (baking). The latter does not include the characteristic "reaction" in its *modus operandi*. The vessels of the surface are dilated at once by the action of heat and are kept in a state of dilatation by the continued and enforced application of heat. Therein lies the therapeutic rationale of superheated air applications. They are indicated (1) in all conditions in which "reaction" can not be brought about or only imperfectly; (2) in cases where the production of primary anemia might cause aggravation of some congested state within the body; and (3) in cases where the condition of the vessel-walls would contra-indicate the violence of a reactive process.

What has been said before expresses in a general way the broad principles according to which the hydro-therapist proceeds at the bedside. The strength of his method lies in the control which he is capable of exercising over circulation, and in this way over (general or local) nutrition. Even the mere emptying and refilling of the blood-vessels of a certain portion of the circulatory system affects nutrition in a manner most striking. Passively hyperemic organs are in this way unloaded, the healthy tone of the organs is re-established, the tissue-change within the organs is stimulated by acceleration and regeneration of the blood-current, products of decomposition and other morbid processes are washed away, retrograde metamorphosis is prevented. There can be no question that the employment of so powerful an agent presupposes familiarity with the condition of the organism at large, and sometimes even more than ordinary finesse of judgment. Calcareous vessel-walls, an apo-

plectic condition, luetic changes in the brain or spinal cord, congestive conditions of the kidneys, etc., are for obvious reasons contra-indications to the employment of heroic hydro-therapeutic measures. The dry-heat cylinder or the electric-light bath would in these conditions be better adapted, although their use should never be haphazard or become a matter of routine. On general principles, however, it is easier to be successful in the use of the dry-heat cylinder and electric-light bath than in the employment of cold water. The latter requires more knowledge, better judgment and some experience. It is the more powerful and more effective agent.

The marvelous effect of thermic stimuli upon regions at some distance from the seat of application has been practically shown by experiments on man and beast. I have already referred to Schueller's experiments on rabbits. The fact that not only the meningeal but the entire intra-cerebral circulation is affected by the thermic stimuli, was shown by a plainly noticeable contraction and expansion of the brain-mass itself. Winternitz, who has done more than any other investigator to define the physiological laws governing the effects of thermic stimuli, proved that during a warm sitz-bath the circumference of the arm decreased, while it increased during a cold sitz-bath. His observations concerning the effects of the thermic stimuli on the central organ of circulation, the heart, and also on the centers of respiration are most interesting. The decided effects of cold upon the local circulation are well shown by Winternitz, who made sphygmographic tracings of the radial artery before and after ice-applications to the brachial artery.

It has been stated that *reaction* is the process through which hydro-therapy accomplishes its great results. Whenever the primary thermic stimulus ceases to act or whenever a stimulus of the opposite character is substituted, reaction will take place. To explain: If we envelop a patient in a cold, moist sheet and place a woolen blanket over the sheet (Priessnitz pack), the action of the sheet will be of bu:

short duration. In a brief space of time the normal body-heat supplemented by the woolen blanket will change the *cold* moist sheet to a *warm* moist sheet. The spaces between the skin and the sheet and between the sheet and the blanket are filled with a warm vapor, which acts as a thermic stimulus opposite in character to the thermic stimulus represented by the cold moist sheet. What takes place in and beneath the skin in response to the new stimulus is what we call reaction. Reaction *must* take place if we wish to accomplish results and wish to prevent harm from being done. If reaction did not take place, the result would be congestions within the organism. Perhaps the patient's lungs or bronchial tubes would remain congested. In the language of the people, *the patient has caught a cold*. By a cold is meant a condition characterized by congestion of one or more internal organs or structures and produced by the action of low temperature on (*i. e.* chilling of) the skin. A cold, hydro-therapeutically speaking, is the result whenever reaction is imperfect or absent. It must be our aim to produce reaction at all hazards. If there is a lack of tonicity in the arterial walls, causing the circulation to be sluggish and nutrition to be bad, we must augment the hydro-therapeutic procedure by other means. Friction and massage of the body-surface might be required to bring on reaction. The question of reaction again calls for nicety of judgment entirely inseparable from accurate physiological knowledge and from the ability to individualize cases. We are again prepared to admit that the successful hydro-therapist must needs be a scientific physician.

It is of some importance to know the effect of a cold or a hot water application upon the body-temperature, or upon the temperature of any part of the body if only a partial application be made. We know that the self-consumption of the body is a process of combustion accompanied by a certain degree of heat. The relative rapidity with which the body is burnt up and the amount of heat produced are in direct proportion. If combustion takes place more rapidly

than the normal physiological process of self-consumption, the process is called *fever*, and is accompanied by a corresponding rise of the ordinary heat of combustion. It is a well-established fact that the physiological heat of the body is maintained by certain automatic safety-apparatus, which equalize the contrast between the temperature within and that outside of the body. High temperature applied to the whole body-surface will necessarily cause a rise of the temperature within the body. The organism at once makes an effort to get rid of the surplus heat through the activity of the sweat-glands, the process of expulsion of surplus body-heat being known as "diaphoresis." If a very low temperature acts upon the surface of the body, the temperature within the organism will of course sink. The organism, however, makes a prompt effort to supply an additional amount of heat by causing the animal-economy to consume itself more rapidly. Metamorphosis of matter and heat-production are always in proportion. Therefore, fever means over-consumption. Its objective evidence is elevated temperature. Physiologically, fever is an attempt on the part of nature to regenerate the body, to burn up morbid material, to make new and healthy tissue. Fever, therefore, is a salutary, curative effort; it is the ally of disease. The organism which is constantly regenerating itself, is doing so with increased vigor when fever supervenes. The surface of the body is studded with innumerable little openings through which gases and vapors constantly escape. When the excreted material is so copious that it can not all evaporate through the skin, it escapes in liquid form (sweat). It is clear what a close physiological relationship exists between fever and perspiration and what valuable therapeutic lessons can be learned from the knowledge of this relationship. The treatment of a febrile condition or— to speak more correctly—an attempt to aid nature in her efforts to save the organism from the ravages of disease, imperatively calls for close attention to the excretory function of the skin. If there is little or no attempt to perspire,

diaphoresis should be brought about by hydro-therapeutic means. Reaction implies active hyperemia of the skin, active hyperemia is synonymous with over-nutrition, over-nutrition means increased functional activity. By regulating circulation we control nutrition and functional activity. Truly unlimited therapeutic resources are contained in this simple but momentous statement; for it holds good, not only in regard to the skin, but pertains to every functioning structure in the body. Granting that we can control circulation, it must be admitted that we can at will regulate nutrition and function locally and generally. We can produce sleep by hydro-therapeutic reaction causing cerebral anemia (Priessnitz pack of the body); we can unload the portal circulation, and thus relieve a congested liver (pack of the abdomen and the lower extremities); we can promptly check hemoptysis by rendering the lungs anemic (pack of the lower extremities), etc., etc., *ad infinitum*. We can—last but not least—help nature in its febrile efforts by stimulating tissue-change and aiding cutaneous excretion, while by well-directed thermic efforts the distressing companion of fever, namely high temperature, is held at bay.

Diaphoresis, however, means more than simple excretion. Just as the organism automatically equalizes the normal heat of the body, it likewise maintains the physiological equilibrium of aqueous elements within the body. This explains the primary effect of diaphoretic action. As the aqueous elements escape through the skin, the total amount of watery elements within the body necessarily diminishes. The blood becomes partly dehydrated, rendering it thicker. Nature makes an effort to restore the proportion of blood-serum by drawing upon the physiological and pathological liquids present in the tissues. In this way diaphoresis produces *absorption*, another of Nature's great curative factors.

Purely reflex effects which may be produced by the action of a local thermic stimulus, *e. g.* a cold douche applied to the back, are physiologically interesting and clinically of

importance. Through the sympathetic nervous system the impression made upon the cutaneous nerves reverberates throughout the ramifications of the sympathetic and explodes at some point or points of selection, the latter being dependent upon circumstances that are not always within our sphere of physiological calculation. The skin responds with striking readiness to stimuli of this kind as well as to any kind of sudden impressions, even psychic in character. This is the physiology of the *cutis anserina* (goose-skin). Being closely associated with the mechanism of respiration the skin communicates its stimuli to the respiratory centers and indirectly to the heart. A sudden cold douche may in this way seriously react upon respiration and circulation by overstimulation and resulting exhaustion of the nerve-supply of the lungs and heart. In the same way the effect of a very cold drink, especially while the organism is functionally very active (in hot weather), might be disastrous, the thermic stimulus being communicated to the general system through the nerves and sympathetic ganglia of the stomach. Every one is familiar with the immediate effect of a sudden cold douche: chilling of the body-surface, deep breathing and violent heart's action. Thermic stimuli that are not sudden and violent, are not *per se* productive of characteristic reflex effects.

Clinical Considerations.

From the theoretical points evolved it is evident that applications of heat and cold are capable of affecting the whole organism in any and all its functions. The effects produced are either *stimulating* (increasing the active circulation in a part, intensifying metabolism, augmenting every manifestation of vitality in the part), or *sedative* (decreasing the active circulation in a part, retarding metabolism, depressing every manifestation of vitality in the part). If cold water is used, the secondary effect is in reality the therapeutic effect, the primary action being temporary and only preparatory. A typical example of "reac-

tion" is the erection which follows the use of the cold sound. In warm or hot applications of any kind there is no preparatory effect. The therapeutic effect is immediate and takes place without a preceding reaction. A continuous cold application would, of course, retard or perhaps prevent reaction by exhausting the responsive power of the vaso-motors. The therapeutic indications are plainly suggested by the following general summary of thermic effects :

1. Short applications of extreme heat or intense cold (thermic shocks) are markedly stimulating even to the point of intense excitation. The action of cold is more profound than that of heat. This is what makes cold applications of short duration and repeated at regular intervals (*e. g.* every day) a powerful tonic.

2. Applications of moderate heat are moderately sedative. A prolonged application of this kind exhausts the functional tone of the cutaneous and sympathetic nerves and is, therefore, depressing.

3. Applications of moderate cold are slightly stimulating. They become less so, the longer they are continued, although they are not depressing.

4. Applications of intense heat, if continued for a long time, are stimulating as long as the skin activity is not too pronounced. Profuse perspiration is distinctly depressant, although this effect usually passes off very quickly.

5. Applications of cold, if continued for a long time, depress the organism even to the point of collapse and death. Cases of sunstroke sometimes succumb to the irrational use of cold water and ice, *en vogue* in some of our public hospitals.

6. Indifferent temperature (*e. g.* a bath at 90°-100° Fahrenheit) produces neither stimulation nor depression. It is sedative because it obtunds the responsive power of the skin-nerves mechanically.

Translating the physiological effects included under these six headings into therapeutic indications, the classification would read something like this :

1. Intense stimulation by short applications of heat or cold is indicated in conditions of extreme exhaustion, collapse and shock, surgical and otherwise, sudden heart-weakness due to heart-disease or the action of an anæsthetic, drowning, syncope, suffocation, psychic impressions and any condition in which there is a sudden failure on the part of the circulatory apparatus. Frequently it is of advantage to alternate the hot and cold stimuli.

2. Moderate heat is an excellent sedative in cases of accentuated reflexes, in all forms of neuroses, in hysteria, nervous irritability and overstimulation.

3. Moderate cold is a useful stimulant in all continued fevers and weakness produced by any cause. If the circulation is sluggish, the reflexes retarded and the vitality of the whole organism below par, stimulation of this kind is indicated.

4. Long-continued applications of intense heat increase the metabolic activity of the organism and produce a wonderfully alterant effect. Excretion and absorption become much more active. This is capital treatment in all forms of gout and rheumatism, Bright's disease, inflammations of the joints, bruises, sprains and many more conditions too numerous to mention. The "baking" process is an illustration of this form of therapy.

5. Applications of cold of long duration are never therapeutically indicated. They should be discontinued the moment local or general depression becomes manifest. Cold applications possess excellent stimulating and antiphlogistic properties and should not be carried to the point of depression. The ice-bag is a splendid but much abused agent. Continuous applications of ice to an injured or inflamed joint, for instance, are absurd. The effect is a suspension of the vital forces and such treatment is the worst kind of meddling interference with nature's reparatory efforts. A short cold application, followed by continued hot application, is splendid, especially in the treatment of conditions in which "baking" is indicated. The preceding cold appli-

cation, by its powerful stimulating action, intensifies the effect of heat.

6. Indifferent temperatures have no special therapeutic significance beyond the slightly sedative action which they produce.

All these effects are physiological. The purely physical action of intense heat and cold is seen in the stoppage of hemorrhage by direct application. It stands to reason that the mucous membranes of the mouth, stomach, rectum and vagina can be acted upon analogously to the skin. The swallowing of small pieces of ice is useful in cases of gastric bleeding. The hot vaginal douche enjoys a well-merited reputation as a restorer of the local circulation and a stimulant of great virtue. A cold water injection into the rectum is a powerful stimulant which affects the whole system. It is useful in cases of exaggerated reflexes, especially acute hysteria. It is plain that all these effects can be intensified by the addition of light and of suitable massage, vibration, etc.

The technique of applying heat and cold has everything to do with the therapeutic effect. For the sake of convenient classification we may divide the applications into such as produce a secondary effect after a preparatory primary action has passed off (reactive applications), *e. g.* the cold douche, which contracts the cutaneous vessels, in order to bring about a powerful secondary hyperemia of the skin. Then there are those modes of application whose virtue depends upon the production of a lasting primary effect (non-reactive applications), *e. g.* the use of superheated air, which aims at a dilatation of the cutaneous vessels and produces this effect directly. The continuous applications of cold and heat are distinctly non-reactive.

The reactive applications are:

The moist pack (local or general). In justice to its originator it ought to be known as the Priessnitz pack. It consists of a *cold* wet cloth, over which dry pieces of woolen

material are placed. The size and the manner of packing will, of course, depend upon the part of the body to which it is applied. The action of the moist pack is as follows: The cold moisture of the sheet causes contraction of the cutaneous vessels. The blood is forced into the vessels of the contiguous structures, causing an acute hyperemia. Soon, however, the reaction sets in, forcing the blood back into the cutaneous vessels, which, as a result, dilate. By this time the normal temperature of the body, aided by the heat-retaining dry woolen covering, has warmed up the moisture of the linen sheet. The pack keeps the skin hot, and in this way intensifies and continues the reaction. An enormous amount of blood is drawn to the surface, leaving the deeper structures partially depleted. The therapeutic value of the moist pack will readily be seen. Every physician knows its value in cases of sore throat, tonsillitis, etc., in which the pack is applied to the neck. If applied to both lower extremities, a relative anemia of the trunk and head is the result. If applied to the abdomen, partial depletion of the abdominal vessels, especially the sluggish portal system, will follow. If any limited part of the body-surface is packed, the result will invariably be an anemia of the part or parts whence the blood-supply of the packed area comes. This form of treatment, by which blood is taken away from one part and drawn to a distant part, is called "derivating method" (*ableitendes Verfahren*). It accomplishes in congestions and inflammatory conditions what venesection aims at, without, however weakening the organism by loss of blood. As a result of the anemia produced, the nutrition of the depleted part or organ will necessarily be affected. Circulation is eventually stimulated, tissue-change accelerated, absorption promoted. Thus we may look upon the Priessnitz pack as an alterative of great virtue. The duration of a pack depends upon the peculiarities of each case, and varies from one to three hours. It has, as will be readily seen, a wide range of applicability. It is useful in all cases of inflammation, where its powerful effect upon the circula-

tion makes it a true antiphlogistic. Congestive headache, insomnia, abdominal plethora, hemoptysis and a host of other conditions can be treated according to the "derivatizing" method with a great deal of benefit. Cases, of course, should be individualized. The physician should employ the method in keeping with its physiological effect. The indiscriminate employment of so powerful a reagent is not without danger. For obvious reasons, organic disease of the heart and degenerative changes in the arterial walls (leitic, calcereous, etc.) are contra-indications. The cold moist pack is probably the best and most easily administered hy-driatic application. Applied to the whole body it is known as the *general pack* (popularly called "the Spanish mantle"). Two or three woolen blankets are spread on a bed. Over them a sheet wrung out in cold water is placed. The patient lies down upon this sheet and is quickly wrapt in (1) the sheet, care being taken to wrap all the extremities separately and to make the sheet fit snugly; and (2) in the woolen blankets, which are wrapt over the wet sheet. The head of the patient is not included, a dry towel being tucked in below the chin and on both sides of the neck, to prevent the air from striking the wet sheet. The duration of the pack depends on circumstances. If the patient stands the pack well, it should not be removed until he has ceased to sweat and is beginning to complain of a clammy feeling. Then the pack is removed and the patient is given a brisk cold rub-down. The general pack is indicated in all conditions in which depletion of the brain is desired (insomnia, inflammatory conditions of the brain, apoplexy, etc.). As a general tonic to stimulate metabolism and increase skin-function it is unexcelled. It is a powerful antipyretic in continued fevers. In diphtheria and all conditions characterized by angina it is a valuable adjunct. In internal congestions (lungs, bowels, liver), accompanied by imperfect excretion, the general pack renders signal service. In all conditions of auto-intoxication it is indicated. For tonic purposes it may be given once or twice a week, as an alterant every day,

as an antipyretic several times daily, depending on the requirements of the case. The average duration of a pack is one hour.

A *partial cold moist pack* may be applied to the body from the feet to the nipple (leaving the arms out), to the lower costal border, to the umbilicus, to the hips to effect depletion above the packed area. In bleeding from and inflammation or congestion of the lungs (hemoptysis, pneumonia) these partial packs are very useful. A cold moist pack to the shoulders and chest (hydriatic shawl, cross-binder) is serviceable to relieve cough, to deplete congested parts in the chest, to force the absorption of pleural exudates. An *abdominal pack* is indicated in intra-abdominal congestions (peritonitis, intestinal inflammation, appendicitis, peritoneal exudates). It has been demonstrated that about one-third of the blood-mass of the whole body can be assembled in the abdominal wall by a pack of this kind. All these partial applications deplete the brain more or less and produce sleep. Localized applications may be made to any portion of the body to produce a derivating effect in some inflamed, congested or inactive region at some distance away.

The *cold douche* is a powerful reactive water-application. It may be general or partial. It may be administered in the form of a fine spray, a coarse affusion or a solid stream. It may strike the body-surface with considerable force or gently. All these factors affect the therapeutic result, which consists in a powerful stimulation of the area treated, increased circulation and coincident derivation from the tributary area. It can be administered by means of elaborate modern devices or by means of more primitive appliances, e. g. the sprinkling-can, which, through the adherents of Father Kneipp, has risen to the level of an important therapeutic auxiliary. A preceding hot application enhances the stimulating effect. The impact of the impinging water stimulates the cutaneous nerves. The tonic stimulating effect decreases in proportion to the length of time

and the temperature of the water. The application should be short (one-half minute to one minute). The water should have a temperature of about 50° F.

The longer the duration and the warmer the water, the less marked is the stimulating effect. Douches may be used after warm applications to cool the surface. They are indicated in all cases requiring local or general stimulation: neurasthenia, especially sexual (douche of the spine), muscular atony, obtunded reflexes, debility. To arouse and modify vitality of the nerves in paralytic and neuralgic conditions the douche is very useful.

The cold rub, either in the form of a sponge-bath or administered by rubbing or slapping the patient's skin through a wet sheet in which he is wrapt, is an excellent antipyretic (in the conditional sense set forth previously) and indicated in febrile states generally. Its therapeutic indications are mainly stimulation and derivation in conditions of faulty metabolism, congestion, sluggish circulation, etc. It may be applied generally or locally.

The cold immersion (full bath, half bath, plunge, sitz-bath, partial immersion) is given in tubs of different shapes and sizes. The physiological effect is identical with that of the other methods of using cold water: stimulation, derivation, antipyresis. If these baths are too long continued, reaction may not set in or only incompletely, causing depression. Baths of this kind (temperature 50°-60° F.) should last from two to ten minutes. In the plunge-bath the patient is actively exercising his muscles, keeping the body and the water in a state of constant agitation. The duration of all cold immersions is gauged by the temperature of the water and by the extent of the area treated. The colder the water and the more extensive the territory treated, the shorter should be the duration of the bath.

Walking in wet grass or newly fallen snow is done for the purpose of depleting the trunk and head. It is a very effective agent and became popular through the followers of Kneipp.

The non-reactive applications are:

Continuous application of cold water (full or partial bath, cold compresses, the running-water coil for the head and other parts of the body, douches, etc.) have no well-marked therapeutic indications unless the area treated is comparatively small. A continuous application of moderate cold has a decided antiphlogistic effect on the region treated and on the tributary and contiguous territory. The larger the area treated, the more marked the general sedative and depressing effect. These applications should be used discreetly and with a well-defined object in view. The area should be limited to get the benefit of the antiphlogistic action of the continuous application of cold. A cold application to the abdomen favors the accumulation of blood in the abdominal cavity and promotes functional activity of the intra-abdominal organs. In constipation, in sluggishness of the liver and intestines, in atonic diarrhea, etc., it can be employed with good effect.

Continuous applications of hot water (full or partial bath, hot compresses, douches, etc.) stimulate the region thus treated during the first few minutes, after which the effect becomes sedative, relaxing and depressing, depending on the extent of the area treated. The vessels of the area treated are dilated and remain so, if the application is continued. Thus, the tone of the vessels is exhausted and the depressing effect follows. Local applications of this kind have an antispasmodic, relaxing and anodyne action. As a preserver of vitality continuous applications of heat frequently serve an excellent purpose. In severe contusions, especially if the soft parts have been crushed and sloughing is inevitable, constant immersion of the part in hot water is by far the best treatment. The old-fashioned flaxseed poultice is, in its therapeutic indications, analogous to the continuous application of hot water.

The vapor-bath (steam-bath) is a producer of copious diaphoresis. Therein lies its therapeutic significance. In most fevers and organic diseases of the central nervous sys-

tem and organic diseases of the heart this form of bath should not be employed without great caution. It is useful as an adjunct in the treatment of metabolic disorders and diseases of the general system (syphilis, obesity, etc.).

On general principles the hydriatic methods that are non-reactive are therapeutically inferior to those which involve the characteristic reaction. The latter are the classical water applications which made the great empirics Priessnitz and Kneipp famous. Stimulation of the vital forces locally or generally is the purpose of all therapy in most chronic diseases. For this reason the use of reactive water-applications is our sheet-anchor in the treatment of chronic maladies. If we try to understand the physiology of the effects produced by the action of cold or heat, we ought to experience no difficulty in adapting these physiological means to our therapeutic ends. Of all branches of practical medicine hydro-therapy is the purest and most scientific. Water is the most useful remedy because it is indicated at all times, has definite action and can be used in an endless variety of ways for an unlimited number of conditions. Compared to water as a therapeutic agent drugs dwindle into insignificance. No drug can take the place of water, but water can take the place of all drugs as shown by the magnificent clinical record established by hydriatists from times immemorial. After making practical use of hydro-therapy in a variety of ways and realizing its almost miraculous therapeutic possibilities, we will be prepared to agree with Pindar of old who never tired of extolling the virtues of water and who summarized his opinion of water in his immortal epigram: "Water is the best of all!"

The Therapy of Dry Heat.

The physiological principles which govern the clinical uses of heat are included in the discussion of thermic stimuli. (See HYDRO-THERAPY.) The depressing effects which follow continuous applications of heat are much reduced in

intensity if dry heat is substituted for moist heat, *i. e.* if air is substituted for water as the carrier of the thermic stimulus. Thus the application can be continued for a much longer space of time and a higher degree of heat employed. Owing to the comparative simplicity of technique, the use of dry heat has become very general and enjoys a well-merited degree of popularity.

The greatest difference between intense degrees of dry and moist heat is the irritating action of the latter on the skin as compared to the mild non-irritant effect of the for-



A THERMIC TREATMENT OF THE KNEE.

mer. This difference in favor of dry heat makes the latter a safer agent to use. Prolonged applications of intense heat have at first markedly stimulating effects. Soon the evidences of overstimulation become apparent. The body-temperature rises, nerve-energy is depressed, the heart becomes weak, respiration is correspondingly rapid and superficial. The system is overcharged with CO_2 . The organism attempts to throw off heat and gaseous waste-products by accelerated and intensified skin-function, *i. e.* copious diaphoresis. Absorption is thus promoted and metabolism stimulated. The demand for physiological fuel on the part of the system frequently manifests itself by increased ap-

petite. The depression usually passes off the moment the thermic stimulus is taken off.

The fact that the characteristic violent "reaction" does not take place, makes a general application of dry heat a comparatively safe procedure in many conditions in which a cold stimulus followed by reaction and heat (*e. g.* in the general cold moist pack) would not be indicated. This is the case in organic disease of the heart, in degenerations of the vessel-walls, in toxic conditions of various kinds and in inflammatory and catarrhal states of the kidneys. In these conditions dry heat applied in a properly constructed cylinder heated by gas, alcohol or gasoline, is a most valuable therapeutic agent which entails no danger to the patient, if ordinary care is exercised by the medical attendant. In rheumatism the effect on excretion is a therapeutic factor which can not possibly be overestimated. In local conditions, such as sprains, contusions and rheumatic joints, dry heat is applied directly to the affected area. The intense compensatory effort made by nature after the excretion and hyper-nutrition which have followed the application of dry heat ("baking"), results in absorption of inflammatory products, of extravasated blood and edematous swellings and in a powerful impetus to the reparative work of nature. Pain is usually relieved very promptly. In a general way it is fair to state that dry heat is the best therapeutic agent in the treatment of bruises, sprains, and especially rheumatism. The statement made by some observers that the application of intense dry heat to inflamed and infected areas, *e. g.* in cases of pneumonia, results in a heating up of inflamed tissue (*e. g.* hepatized portions of lung-tissue) and in this way acts as a direct germicide, is theoretically and practically untenable. It is erroneous,—(1) because the action of germicidal heat would be coincident with suspension of vitality and destruction of organic tissue (Winternitz); (2) because intense heat would seriously interfere with the function of the absorbent and blood-vessels in the process of repair; and (3) because intense heat has a tendency to

A GENERAL DRY-HEAT TREATMENT.



coagulate the blood-albumen, to disintegrate the blood-pigment and impair the oxygen-carrying (germicidal) power of the red corpuscles. The use of dry heat should be restricted to conditions characterized by passive hyperemia and by sluggishness of local and general metabolism, *e. g.* sprains, bruises, chronic rheumatism, nephritis, etc., etc. In order to "derivate," it is sometimes of advantage to apply dry heat to a part at some distance from the inflamed area.

The electric-light bath (Kellogg's incandescent bath, Minin's thermic-ray apparatus) is also a mode of applying dry heat. To what extent and in what manner the light enhances or modifies the action of heat, is a matter of speculation. There is no doubt, however, that the light itself adds an element of importance to the procedure. In the incandescent bath a temperature of 115° F. is therapeutically equal to 350° F. in the hot-air cylinder heated by gas. This is the statement of Winternitz, which has been corroborated by many other clinicians. The light which strikes the nude skin has a characteristic action on the skin-nerves which is absent in the effect of the ordinary dry-heat cylinder.

In administering a general "bake" the body of the patient is covered with one layer of bath-toweling (robe, mittens and stockings). The head is kept out of the cylinder. The heat is turned on and allowed to rise slowly. The patient soon begins to sweat. After the heat has been on for twenty to thirty minutes, the patient sweating profusely, the heat is cut off and the temperature allowed to slowly drop. When it has dropped to approximately 100° F., the platform should be rolled out, and the patient quickly and thoroughly rubbed dry, the wet robe, mittens and stockings having been removed. The patient is now pushed back into the cylinder nude, the temperature in the cylinder being the ordinary comfortable temperature which usually remains in it after the intense heat has been on previously. The heat is not turned on. The cylinder is closed so that only the head of the patient protrudes. A secondary sweat now begins which can be allowed to continue for one-half

hour or longer. The patient is then taken out, dried off, given a brisk cold rub and rubbed dry. Then the patient is allowed to lie on a lounge and rest. During the "bake" the patient, if he asks for water, should be allowed to drink sparingly. The water should not be ice-cold. His face should be wiped frequently.

It should be remembered that temperature is purely a relative term. The heat during a "bake" should be regulated, not by the thermometer, but by the condition of the patient. Precordial distress, dyspnea, palpitation of the heart, a bursting headache, syncope, nausea are indications that the patient has passed the point of tolerance. The heat should be turned off at once and cold water applied to the patient's head. Sometimes the patient has to be taken out without delay. Ordinarily it is sufficient to apply cold to the patient's head and open the vent-holes of the cylinder. After the "bake" massage or any other form of treatment can be administered. The patient should not take a general dry-heat bath on a full stomach. Treatment of this kind can not be given oftener than three times a week. In many cases two treatments a week would be the limit. In cases of metabolic disorders, especially rheumatism, the patient should be given the treatment up to the limit of tolerance. In diseases of the circulatory organs and in renal disorders mild treatments frequently repeated are preferable. In chronic Bright's disease the application of cold to the skin is never without some danger. Care, therefore, should be exercised in administering a cold rub-down after a general dry-heat treatment.

In administering a local treatment, *e. g.* to a sprained ankle, the general condition of the patient is usually of little concern. The technique is of great consequence. The part should be carefully covered with three, four or even more layers of Turkish toweling and placed in the cylinder of suitable size in such a way that the heat will nowhere come in contact with the skin. The temperature can be raised to the point of tolerance and kept there as long as the

patient does not complain. A local "bake" should not last longer than thirty minutes, if properly administered. The part is not put back for a secondary sweat. This is only done in giving the general treatment. Local treatments should always be followed by massage. They can be given every day or every other day. The part, after a bake, will usually be found to be red, warm, pliable, without pain and capable of being manipulated without discomfort to the patient. In giving a general treatment the most common disagreeable complication is fainting. In the local treatment the operator should concentrate his attention upon the possibility of burning the patient's skin. (See RHEUMATISM.)

The high-temperature thermometer as a gauge of the degree of heat should be freely suspended in the cylinder without any metal cover. The latter makes the thermometer worthless because the instrument is influenced by the intense heat which is absorbed and retained by the metal case. As stated before, the condition of the patient is the only criterion by which the intensity of the thermic stimulus and the duration of the treatment should be judged. The principles underlying the therapeutic indications of dry heat are included in the discussion about HYDRO-THERAPY.

CHAPTER V.

MECHANO-THERAPY.

“MECHANO-THERAPY” is a collective term which includes all forms, methods and systems of exercise and of manual and instrumental manipulation of the tissues of the body. It may be subdivided as follows:

1. EXERCISE comprises the sum-total of the movements which represent the functional activity of the voluntary muscles of the body. Being primarily essential for the preservation of health locally and systemically, it is rather a *hygienic* than a therapeutic measure. When it is performed methodically and as a part of a well-conceived system of treatment in any given case, it becomes a *physio-therapeutic* measure and belongs properly under the head of Swedish gymnastics or movements.

2. SWEDISH MOVEMENTS are a therapeutic system of muscular movements of fixed duration, direction and purpose. They are sometimes referred to as “kinesio-therapy” (movement-cure).

3. MASSAGE is a system of manipulations which are administered to the soft tissues of the body by the hand or hands of a specially qualified operator or by suitable massage-instruments.

4. BONE-SETTING is an empirical method of restoring the functions of the joints and of curing many of the complications and sequelæ of fractures, dislocations, etc., by the breaking-up of adhesions and by applying massage and passive motion. Bone-setting as a special kind of craft is now almost obsolete.

5. ORTHOPEDICS. Orthopedic mechano-therapy is a system of movements and manipulations whose object is the

correction of certain deformities by restoring the normal structural and functional relation of certain parts of the body to each other as far as such restoration is possible.

6. **OSTEOPATHY** is a system of movements by which displacements of bony structures are to be corrected, the supposition being that "all diseases are due to definite lesions consisting of bony displacements and that treatment and cure must necessarily consist in and follow removal of the cause."

7. **VIBRATION** is a mode of mechano-therapeutic manipulation by which impulses of a more or less energetic character and with greater or less rapidity are imparted to the tissues of the body, the generating source of vibration being the hand of a skilled operator or preferably a suitably constructed instrument called a "vibrator."

8. **OSCILLATION** is a more or less violent shaking up of the soft tissues of one or more regions by the hand or hands of a trained operator or by the application of an instrument called an "oscillator."

For practical purposes the different modes of movement or manipulation can be classified in a much more simple and concise manner. Since ordinary *exercise* is to all intents and purposes a part of the so-called Swedish movements, it can practically be left out of consideration as a special form of mechano-therapy. *Bone-setting* is a motley and empirical mixture of massage and Swedish movements, practiced by men without technical knowledge, but endowed with a wonderfully fine sense of touch and a knack of manipulation. *Orthopedics*, in as far as it is related to manipulative procedures, is also a compound of massage and Swedish movements and, therefore, does not represent a distinct subdivision. *Osteopathy* was included for the sake of completeness. Being a drugless method or system and having the charm of novelty, it has gained unprecedented popularity in all parts of the country. Neither its theories nor the practical results achieved by their application justify the prominence which it has achieved recently. Noth-

ing can be accomplished by an osteopath that can not be done by an expert Swedish masseur. Those who extol osteopathy as a new system of practice are attracted by the glamour of novelty and, in a measure, by its suggestive influence. Osteopathy, in its approved form, can not live because its pathology is not sound and its range of practical application is limited. The number of osteopaths who are including the other physio-therapeutic methods in their practice is constantly growing, thus furnishing a mute but eloquent proof for the clinical insufficiency of the osteopathic creed. The success of osteopathy, however, shows the drift of the times in the direction of drugless methods. Osteopathy has given a new and powerful impetus to the study of anatomy and physiology and to the analysis of the intentions of Nature as expressed in the sciences of hygiene and dietetics. In this respect the announcement of the osteopathic creed was of historical moment. Osteopathy has fulfilled its mission. It served as an auxiliary wedge in the interests of an incomparably greater cause, to wit: physio-therapeutic medication. Osteopathy as a system can not and will not live. Even now the evidences of decay are too plain to be ignored. The well-meaning and intelligent osteopaths who have a good knowledge of the essential branches of medicine and are correspondingly well-posted in the collateral natural sciences, may continue under the name of osteopaths, but they will, to all intents and purposes, be practitioners of modern, *i. e.* physiological medicine.

If we eliminate exercise, bone-setting, orthopedics and osteopathy from our classification, mechano-therapy still retains four subdivisions, to wit: massage, Swedish movements, vibration and oscillation. If the latter two are applied by means of the hand, they belong properly under the head of massage. They are a special or specific form of mechanical treatment if they are instrumentally applied. It would seem, therefore, as though the mechano-therapeutic methods could well be divided into those which are applied by hand (*manual*) and those which are strictly *instrumental*.

In keeping with this simple and convenient classification I shall endeavor to present the strictly manual methods under the heads of massage and Swedish movements, and the instrumental methods respectively under the heads of instrumental massage, instrumental gymnastics, vibration and oscillation.

Massage.

Massage is the oldest mechano-therapeutic method because its practice is suggested by the very sensory and motor instincts of the organism. When a man receives a sudden bruise, he will instinctively grasp the injured part, stroke it and rub it. When a child falls and bruises its forehead, the mother will press and stroke and rub the bruised portion until the child, partly as the result of the massage administered and partly in response to the suggestive influence of the mother's caresses, will become quiet and perhaps fall asleep. A man rubs his leg when, for some reason or other, it hurts. A good rubbing is the accepted form of treatment for lumbago, although the average man is prepared to give credit to some liniment employed rather than to the rubbing which is the real remedy. The experienced old woman strokes the brow of the fever-patient who complains of a headache. Even among the lower animals the instinct of relieving discomfort or pain by massage is well marked. Who has never seen a dog or a cat licking an injured limb? Who has never beheld the pleased expression on a dog's or a cat's face in response to and in grateful appreciation of a gentle rubbing? The sedative and anodyne effect of massage is generally known. There seems to be no doubt that the healing by the laying on of hands which is spoken of in the New Testament and was *en vogue* among the early Christians refers to a crude form of massage.

The elaboration of massage as a therapeutic measure is the work mainly of two men: P. H. Ling, a Swede of much versatile talent, who tried to systematize the subject during the early part of the nineteenth century, and Prof. Mezger, formerly of Amsterdam, later of Wiesbaden, who is really

the scientific originator of massage as a branch of practical therapeutics. The system followed by Mezger is adhered to by masseurs generally. He recognizes massage (from the Greek word *massein*, to knead) as a system of manipulation applied to the soft parts for certain purposes and according to certain rules. He distinguishes four different varieties of massage-movements, to wit: stroking (*effleurage*), rubbing (*friction*), kneading (*petrissage*) and beating (*tapotement*). In reality there are but three fundamental varieties, to wit:

EFFLEURAGE.—Under this head are included all varieties of massage consisting of pressure evenly and uniformly continued along a certain path. This path may be a straight line (linear *effleurage*) or a more or less curved line (circular *effleurage*). The latter variety coincides with Mezger's *friction*. The means of which the operator avails himself for the purpose of administering evenly continued pressure along a given path (*effleurage*) are suggested by the topographical characteristics of the region treated or by the effect to be produced. The operator may use the palm of one hand (for extremities, posterior portion of head), or both palms (for chest, back, both sides of neck, extremities of adults of large stature), one or both thumbs (for inter-muscular spaces, inter-ossei), or the tips of the fingers (whenever it is necessary to adapt one's self to the peculiar shape of a part, *e. g.* a joint). It seems entirely proper to classify *effleurage* and *friction* under the same head. They only differ in the direction in which the stroking is done. It is important to remember that *friction* should always be followed by centripetal *effleurage*, *i. e.* by stroking-massage from the periphery towards the center (in the direction of the venous and lymphatic circulation).

PETRISSAGE is the manipulation and kneading of a part between the fingers or hands of the operator (simple *petrissage*) or between the operator's hand or some part of it and the underlying hard tissues of the patient (compound *petrissage*). Simple *petrissage* would be, for instance, the

picking up and kneading of the body of the biceps muscle of the patient between the thumb and index finger of the operator. If the operator were to place the fingers or the palm over the biceps and knead the latter against the resisting hard tissue of the humerus below, this would be a case of compound petrissage. If the operator were to place the upper arm of the patient between the palms of his own hands and knead the arm vigorously, it would be a mixture of the two varieties. In petrissage the fingers or hands of the operator do not glide over the skin of the patient, but remain in firm contact with it, carrying it along. Petrissage may be done with two thumbs or with the thumb and fingers of one hand or with both hands. Petrissage is a mixture of varying pressure, squeezing and pinching. It is useful for the purpose of stimulating the local metabolism and of loosening adherent and contracted fibers.

TAPOTEMENT (percussion) consists in slapping, clapping, beating or chopping the parts by means of the tips of the fingers, the palms of the hands, the whole palmar surface, the ulnar side of the hands or the fist, as the case may be. The succession of blows which are thus administered to the soft parts have an intensely stimulating effect and prepare the parts for other forms of massage.

The principal technical difference between effleurage and petrissage is that in the former the fingers or hands of the operator glide over the skin of the patient, while in petrissage the skin of the patient is carried along in order to act upon the subcutaneous and deeper structures. There is no sliding except when it becomes necessary to change to another area. In giving the different forms of effleurage the patient's skin should be slightly anointed. The best substance for this purpose is olive-oil, although lard and vaseline are largely used by many good operators. On hairy surfaces, oil should be used liberally. All forms of massage must be given on the nude skin.

Massage is an art which can not be taught except by actual demonstration. Much depends upon the aptitude of

the masseur or masseuse who will eventually educate his or her touch (*tactus eruditus*), without which massage will necessarily always remain bunglesome and amateurish. The operator should cultivate clean, soft and well-groomed hands. Cleanliness is a factor of prime importance. The patient's skin should be cleaned with alcohol before the treatment, and hot water and soap after massage has been administered. Massage does not mean strength on the part of the operator. A good masseur spends but little energy. Beginners are likely to overdo things and bruise the patient. Experience means everything in this respect.

The physical elements which go to make up the different movements of massage, are (1) *contact*, or the simple juxtaposition of two surfaces (skin of operator and skin of patient); (2) *pressure*, or the application of a certain amount of energy to the touching surfaces; (3) *variation of pressure*, or the change of the direction or the intensity of the pressure applied. The physical effect of contact is stimulation, both motor and sensory. Simple contact causes an impression to which cellular bodies respond by an attempt at contraction. The amœba contracts very energetically in response to mere contact. In animal bodies contact starts a wave of energy which travels along the pathways of nerve-force. Sensation is a part of the nerve-impression which contact produces. The mysterious rôle which the nervous system plays in the life-processes of the animal-body has opened up a wonderful and almost unlimited field for speculation along the lines of *animal magnetism* or *psycho-magnetism*, with all its vagaries and wonderful phenomena, real and alleged. The effect of massage can be fully explained without resorting to the mysticism of magnetic healing. The effects of massage are either physical or physiological.

The *physical* effects are mainly thermic in character. Motion or friction produces heat. An increase in the temperature of a living organism up to a certain point means increased speed in the wearing away of substance and augmented intensity in the usage of the force consumed. *Phy-*

siologically the effects of massage are produced through the circulatory apparatus, especially the arterioles and the nerve-mechanism controlling them. Arterial stimulation, active hyperemia, increased functional activity, more active nutrition, secretion, excretion, absorption, in fact more rapid and thorough metabolism in the part or parts subjected to massage, are the links in the chain of the physiological phenomena produced by massage.

Massage causes a rise in the arterial pressure which is invariably associated with a coincident stimulation of the venous and lymphatic flow. Excretion through lungs, skin, bowels and kidneys, as a result of general massage, is increased. Metabolism improves. In a general way these effects represent the range of therapeutic usefulness of massage locally and generally, as will be seen by the following résumé of the experimental work done by a number of observers.

Tapotement over the heart and in the inter-scapular space is followed by retardation and increased fullness of the pulse. The excretion of CO_2 through the lungs is diminished. The accumulation of CO_2 in the blood and the subsequent irritation of the vagus and the vaso-motor nerves probably account for the effect referred to. Tapotement over the stomach and intestines causes a decrease in the abdominal arterial circulation, which, however, is only temporary. A reaction soon takes place which brings about a most decided active hyperemia and increased functional activity. Superficial effleurage, both linear and circular, stimulates the circulation. Deep massage depresses the heart's action and retards the pulse.

General massage excites the vaso-motors and in this way causes constriction of the peripheral vessels and increased blood-pressure in these vessels. Eventually the venous flow is increased. The heart in response to the increased demand for *vis a tergo* beats faster and fuller. The resulting fatigue from overwork causes depression of the heart's action. The arteries of the periphery dilate and in

this way relieve the heart. Deep abdominal massage relieves the vessels of the periphery. The hands and feet grow cold from lack of arterial blood. Intra-cranial anemia may cause the patient to faint. Thus we see that massage acts most energetically upon the circulation. As far as the hematopoietic function is concerned, it is believed that massage is capable of increasing the amount of the blood-coloring matter and also the number of red blood-cells.

The experiments of Winternitz have demonstrated the influence of massage on the heat-production and heat-radiation in the animal economy. General effleurage causes a tremendous increase in the radiation of heat-units from the body. The temperature drops, which clearly shows the value of massage as an antipyretic in the acute fevers. The immense radiation of heat through the skin causes the surface-temperature to increase while the body-temperature (rectal) drops.

Massage stimulates the action of the absorbent vessels in a marked degree. This has been abundantly proven by experiments on animals. A definite quantity of water was injected into the peritoneal cavity of rabbits. One animal was killed after one hour and the quantity of water remaining was measured. Another animal was killed after two hours, another after three hours, accurate measurements of the water remaining being made. A fourth animal was given abdominal massage after the injection of water. It was found that massage caused the fluid to be absorbed twice as fast as it would be without massage. Injections of red ink into the knee-joints of an animal, one joint being subjected to massage after the injection, showed that massage had caused the ink to disappear entirely from the massaged joints and to appear in the lymph-vessels as high up as the hip. In the other joint no change had taken place.

The salol experiment of Ewald furnishes probably the most exact and conclusive evidence. Ewald demonstrated that salol, being insoluble in the gastric juice, is broken up

into its chemical constituents and thus rendered soluble in the alkaline contents of the duodenum. It is thus readily absorbed and finally excreted through the kidneys as salicylic acid and sulpho-carbolic acid. After acidulating the urine with HCl and shaking with ether, a little perchloride of iron solution is added, the reaction taking place by the production of a reddish violet precipitate. In dogs whose pylorus has been ligated, the test is negative. The reaction in the urine of dogs takes place about forty-five minutes after administering the salol. If, after giving salol, the abdomen is massaged, the reaction in the urine can be verified in about twenty-five minutes. The salol reaction in the urine of man ordinarily takes place in from two to three hours. If massage is given, the reaction takes place in about an hour, showing the intense effect of massage on metabolism. All secreting glands (salivary, gastric) can be stimulated and their secretion increased by massage. Skin-massage augments the excretion of water through the skin 60 p. c. General massage has been shown to increase the quantity of urine, the proportionate amount of uric acid and solids in the urine. It stimulates the appetite, the power of assimilation and the conversion of albumins. It increases the proportion of HCl in the gastric juice. The fat-output in the feces is much lessened. Massage augments the flow of lymph in the thoracic duct and in the lymphatic vessels generally. In this respect massage acts like exercise. In an active organ the flow of lymph is steady, whereas in a condition of rest of the organ the circulation of lymph is almost suspended.

Boas demonstrated that regurgitation of the intestinal contents into the stomach through the pylorus can be accomplished by kneading of the abdomen from the right iliac space toward the median line. Massage in the direction of the peristaltic movement augments the latter and regulates the bowel-function. The desire to have a stool, which usually follows a meal, especially breakfast, is due to the pressure of the stomach on the superior mesenteric plexus

and exemplifies the effect of pressure on the movements of the intestines.

The effect of massage on the nervous system is of the utmost clinical importance. Nerves are stimulated by massage until a certain point is reached when overstimulation manifests itself by a condition of fatigue and rest. Thus massage over a healthy nerve causes local irritability and pain as the result of stimulation. Massage along the course of an aching nerve is invariably followed by relief of pain (through stimulation which is equivalent to increased nutrition and healthy blood-supply). Mild pressure increases the irritability of nerves, firm pressure lessens and eventually suspends it. A few examples might serve to illustrate these points. Continued light pressure over the occipital nerves is a sedative of wonderful power. Pressure upon the phrenic in the neck relieves spasm of the diaphragm. Cramps or tremor of muscles can be controlled by pressure upon the corresponding peripheral motor nerve. Strong pressure upon a nerve controls the pain of neuralgia of that nerve. It has likewise been shown that deep structures can be reached and acted upon by vibratory and other forms of massage of the surface as long as the nerves of the region treated and of the deep part to be reached come from the same segment of the cord. Spasmodic conditions of the bronchioles and of the circular muscular fibers of the intestines are relieved by tapotement or vibration over the surface nearest them.

Maggiore studied the effect of massage on muscles with the aid of the ergograph and found that massage applied to resting muscles increases their power for work and retards fatigue, that it prevents the accumulation of fatigue-products in a muscle, that it qualifies a muscle for work more than a corresponding amount of rest, that the different forms of massage affect muscles in different ways, that massage increases not only the capacity for work, but actually stimulates the growth and development of muscle-tissue, that massage restores the tone and strength of muscles if the

latter have suffered from the activity of any cause that has affected the whole system, *e. g.* overexertion, physical or mental. The researches of Maggiora, as well as those of other observers whose experimental work has been previously alluded to, are quoted by Gerdine in an excellent compilation of the literature and bibliography of the subject.

With the physiological effects of massage firmly fixed in our mind the application of massage becomes as much of a problem in clinical medicine as the use of any other therapeutic agent. The contra-indications are easily understood. Massage should not be practiced on sore, inflamed or broken skin, over atheromatous blood-vessels, in cancer or abscess on account of the danger of encouraging metastasis, in inflammatory and painful affections of the deep tissues, notably the bones, in pregnancy, in fact in all cases where the benefits derived from massage would be more than counterbalanced by the local or systemic damage done. Frequently it is of advantage to massage the parts which are near the seat of trouble. In this way the neighboring lymphatics can be stimulated and absorption of inflammatory products, waste, etc., started. It is important to remember that the veins and lymphatics are near the internal border of the flexor muscles and that the massage movements should be in a centripetal direction. Muscles that are being massaged should be in a thoroughly relaxed condition. The average duration of local massage is ten to fifteen minutes, of general massage one-half hour to an hour.

GYNECOLOGICAL MASSAGE.—The application of massage in the treatment of many diseases peculiar to women was given to the profession by a layman, Thure Brandt, an officer in the Swedish army, who, like many educated Swedes, was a master of the art of massage and was led to apply its principles to a condition of prolapsus uteri from which his own wife suffered. The skill of the accomplished masseur, coupled with the tender love for and devotion to a good wife, resulted in a complete cure and established the

possibilities of massage in gynecological practice. That Thure Brandt's method, if applied by an unprejudiced mind and a skilled hand, is an agent of wonderful power, has been established beyond the shadow of a doubt. It is advocated and practiced by conservative gynecologists the world over. The opposition to it comes exclusively from those who know nothing about it and others who discountenance any method of treatment except surgery. Gynecological massage has long ceased to be the method of a layman whose work bore the ear-marks of empiricism. It has been systematized by men of unquestioned ability, *e. g.* Saenger.

Ziegenspeck, in his excellent book on "Thure Brandt Massage," summarizes the indications of and contra-indications to this form of mechano-therapy in a most practical manner. Brandt himself states with his characteristic laconic brevity that pus and cancer are the only contra-indications. Ziegenspeck interprets Brandt's epigrammatic statement by including under the head of cancer every malignant new formation, and under that of pus all infectious germs in the internal genitalia. We might add all acute inflammatory conditions in or near the genital tract and also pregnancy. It is well to remember the liquified products of a purulent inflammation eventually lose their infectious character and, therefore, are no contra-indications to massage (*e. g.* chronic pyo-salpinx). Massage, according to Ziegenspeck, is indicated in chronic ovaritis, peri-ovaritis, salpingitis, hydro- and pyo-salpinx, chronic peritonitis (fibrinous or adhesive), pelvic exudates, chronic inflammatory conditions in or near the uterine body. The classical type of technique which Brandt originated consists in the introduction of the index and middle fingers of the left hand into the vagina up to the seat of trouble and fixation of the latter by the counter-pressure of the right hand, which is placed on the abdomen. The manipulation of the affected part results in a stretching, a toning up of the chronically inflamed tissues and a loosening up of adhering bands. In

addition to this form of local treatment Brandt applies general Swedish movements and makes suitable hydrotherapeutic applications to produce a "derivating" action. The application of Brandt's method requires endurance and a special kind of technical skill which can only be acquired by experience and constant practice. Theoretical knowledge is not sufficient to enable one to practice Brandt's massage successfully or to give an intelligent opinion concerning its relative merits. The best schooling is to attempt the treatment in a mild case of prolapsus or in one of pelvic exudate. Perseverance in the treatment and constant mental concentration on the theoretical points involved will soon—after a few weeks—give practical knowledge to the operator and relief to the patient. Incidentally good anatomical knowledge of the pelvic contents of woman will facilitate progress very materially. In conclusion let me add that Brandt's massage has been applied to cases of prolapsus recti with much success.

Swedish Movements.

According to P. H. Ling "a movement is any form of exercise with a fixed duration, direction and purpose." The systematic employment of such movements is the object of that branch of mechanical therapeutics known as Swedish movements, gymnastics, kinesio-therapy (*Schwedische Heilgymnastik*).

A "movement" consists in the change of the body or any part of it from a given position to another position according to certain rules. The movement begins with a fixed position of the body or of a part of the body. The body or a part of the body goes through a motion of fixed speed, rhythm, direction and extent, until a position is reached in which the performance of the motion is supposed to terminate. Ling, who has systematized this form of mechanical therapy in a most ingenious manner, recognized five principal positions of the body (standing, sitting, lying, kneeling, hanging) and numerous secondary positions which are va-

riations of or deviations from the five principal positions (squatting, standing on one foot, standing with legs separated, standing with outstretched arms, leaning backward, bending forward, sitting astraddle, lying on back or side, etc., etc., etc.). These positions are the beginning and the end of a "movement."

The "movements" proper are suggested by the normal functions of the muscles of the organism. There are three principal movements, to wit: flexion, extension, and rotation. Ling enumerates eight more, which, however, are but sub-varieties of the three principal movements and are best discussed as such.

Flexion (bending) is the motion of one or more flexor muscles; *extension* (straightening) consists in the exercise of extensor muscles; *rotation* (pronation, supination or both) is the turning of a part around its longitudinal axis.

If the patient performs a movement by his own will and effort, unaided and unhindered, the movement is *active*.

If the patient does not perform the movement by his will and effort, but allows the operator to cause certain muscles (of the patient) to relax or contract in response to the operator's will and effort, the movement is *passive*.

If the patient performs a movement and, while doing so, overcomes resistance, the movement is called *concentric*.

If the patient resists the efforts of the operator to extend, flex or rotate certain muscles (of the patient), the movement is called *excentric* (eccentric).

To illustrate: If the patient is told to bend his arm and does so unaided and unhindered, he is performing an *active* movement. If the operator grasps the patient's arm at the wrist and near the shoulder and bends the patient's elbow, the patient neither co-operating nor resisting, the movement is a *passive* one. If the patient bends his arm while the operator holds the arm and resists the patient's effort, the movement is *concentric*. If the operator tries to bend the patient's arm while the patient resists, the movement is *excentric*.

The position of the patient's body and the motion to be performed are indicated in the name which Ling gave to the different "movements." Thus, he speaks of *lying-flexion of the body*. The patient is in the primary *lying* position. The flexion of the body in gradually assuming the final *sitting* position is the movement to be performed.

In discussing massage I have indicated the physiological meaning and importance of *exercise*. Whatever has been said concerning this subject, holds good in regard to the so-called Swedish movements. Inasmuch as "movement" is to all intents and purposes *exaggerated exercise*, the statements concerning the physiology of exercise might be repeated with additional emphasis in regard to Swedish movements. To exercise a muscle means to preserve its functional capacity (power of contraction and relaxation). It means to regulate the process of local metabolism (nutrition, assimilation and excretion). Work, in its physiological sense, is inseparable from life. Life, objectively considered, is the sum-total of physiological activities. The body or any part of it needs exercise to keep it in a physiologically normal state. Lack of exercise means a depression of the process of metabolism. Oxidation (combustion) becomes imperfect and sluggish, the waste products are not thrown out, but accumulate, and impair the functional and structural integrity of living tissue. Venous congestions are the result. The nerves are ill nourished. The whole organism suffers. The resisting power of the body is lessened. Locally and systemically the quality of the tissues of the body is below par,—all for the want of a physiological necessity, namely exercise.

The muscular system requires its period of alternate work and rest, of contraction and relaxation. This is a physiological law, the violation of which means disease in its thousand various forms. The greatest preventive of disease is the preservation of the resisting power of the organism. Therein lies the enormous importance of exercise or, in its methodical form, of Swedish movements. If the

muscles, ligaments and tendons have, as a result of disuse or of inflammatory conditions, lost some of their functional power and have become atrophied or contracted, exercise of these parts is the physiological remedy. Therein lies the therapeutic importance of Swedish movements. Their power of modifying metabolism makes them a blood-producer of greatest value. They increase nutrition and improve it by augmenting the quantity and altering the quality of the blood. The function of the lymphatics is stimulated. Respiration is improved. The whole organism, in all its vital functions, receives the benefit.

To illustrate these physiological considerations and their application in the practice of the therapeutic indications involved, I will confine myself to giving a few of the most characteristic movements. After the reader has thoroughly grasped the underlying principles of these movements in their relation to the functions of the organism and its parts, he will have no difficulty in enlarging the scope of application and in adapting many kinds of movements to the never-ending varieties of disease and diseased conditions.

In the treatment of habitual *constipation* Swedish movements can often be employed with much advantage. The object of all these movements is to make pressure upon the abdominal contents, to firmly contract the muscles composing the anterior abdominal wall and to act upon the celiac and hypogastric plexus which control the mechanism of the bowel-function. The simplest movement is the slow bending of the body forward while the patient stands or sits. The patient while standing bends forward without bending his knees and until the tips of the fingers touch the toes. The movement, both forward and back to the standing position, should be performed slowly and repeated ten to fifteen times. Another movement is the slow raising of one or both legs without bending the knees, while the patient lies on his back. Still another is the suspended position, the patient alternately drawing his legs up to his body and extending them. Some of these movements can be exaggerated and

thus be made more effective. Instead of lying on a couch full length, the patient can lie down on a table or bed with his hips on the edge, leaving the lower extremities without support. This position makes the movement of raising the extremities much more of an effort. Another variation consists in lying down on a couch, drawing the knees up toward the abdomen and then extending the legs.

In the treatment of many cases of *tuberculosis pulmonum*, Swedish movements are of great value, especially in increasing the expanding power of the chest. I beg to refer the reader to the second part of this book where, under the head of TUBERCULOSIS, this subject is considered at some length.

Swedish movements are advantageously combined with massage, galvanism and faradism. The principal thing is to not abuse a good thing by overdoing it or by misapplying it. To have exhausted the patient completely is a sure sign that the judgment of the operator is at fault. Massage or movements should never cause pain, exhaustion or other damage. In some cases it might be desirable to shorten the duration of the treatment or to lessen its severity. One valuable feature of massage and movements is that the dose can be adapted to even the weakest and most sensitive patient. Mechano-therapeutic methods should not be applied while the stomach is full. Their effect might interfere with the function of the stomach, by drawing blood away from it and thus impairing its digestive power. The operator should keep the anatomical structure and the physiological function of the different parts of the organism in his mind. In adapting the Swedish movements to the condition of an individual patient, the habits and mode of living of the patient should be inquired into. A clerk, for instance, who leads a sedentary life, needs Swedish movements applied to every part of his body as a substitute for exercise. A letter-carrier, who is constantly using his lower extremities might be in need of a proportionate amount of exercise applied to the muscles of his back, chest or arms. In all these

cases experience should shape the judgment of the operator in adapting means to the end and individualizing the cases.

[N. B.—For special forms of mechano-therapeutic applications (notably the Nauheim Method in diseases of the heart) the reader is referred to the Therapeutic Index.]

Instrumental Massage and Instrumental Movements.

While there is no doubt that the human hand, if endowed with the necessary skill and guided by intelligence, is the most perfect instrument, it is often necessary to substitute mechanical appliances for the trained hand, especially when patients are treating themselves at home under the direction of the physician and in large institutions where there is a great deal of mechano-therapeutic work done.

Instruments have been devised for the purpose of administering the different forms of massage, especially effleurage and tapotement. These instruments (massage-rollers, massage-balls, massage-hammers, etc.) are supposed to be held and guided by the hands of the operator. In the simple forms of stroking and percussion they answer very well. Where, however, the *tactus eruditus* is necessary to reveal the local condition and its peculiarities, these instruments are, of course, practically worthless. On general principles their value has been overestimated by the laity. They can never supplant the hand of the trained masseur and are likely to do more harm than good on account of the ever-present temptation to use them. Only the physician can estimate the effect of the massage-instrument and the range of its proper use. On general principles, I believe that a vast amount of harm has been done by the misuse and overuse of these appliances. The multiple ball-roller (small balls on a cord), held by both hands of the patient and drawn across the abdomen, is useful in encouraging the absorption of surplus adipose tissue in the abdominal wall. The cannon-ball as a massage-instrument in the treatment of constipation enjoys well-merited popularity. One point in its favor is that it frequently does good while it hardly ever

does any harm. A splendid feature of many of these mechanical massage-devices is their adaptability to the use of electricity in conjunction with massage. Galvanism and faradism can be combined with their use if they are properly constructed to serve as conductors of electricity.

Of much greater importance than the massage instruments are the mechanical devices for the administration of movements and gymnastic therapy. The use of these appliances for therapeutic purposes will always be associated with the name of Dr. Gustav Zander, a Swedish physician, whose set of Swedish-movement-machines are a monument to his mechanical genius which was only equaled by his splendid skill as a physician. Zander classifies his machines under four different heads, to wit:

1. Machines for active movements. There are altogether thirty-eight of these machines intended respectively for the upper and the lower extremities, movements of the trunk and machines for balancing;

2. Machines for vibration, pressure, tapotement, petrissage and effleurage. There are thirteen machines of this kind;

3. Five machines for passive movements;

4. Ten orthopedic machines, mostly for curvatures of the spine.

These machines are wonders of mechanical construction. They are accurately adapted to their purpose and are capable of the finest adjustment of speed, energy, etc. Most of them are operated by electric motors.

The employment of complicated and expensive apparatus of this kind is necessarily restricted to very large institutions. The physician who wishes to add the movement-cure to his therapeutic armamentarium will have to confine himself to the use of simpler and less pretentious devices. Quite a number of these have been placed on the market and are easily obtainable. Home-made machines of primitive construction frequently render excellent service. A familiar example is the iron ball which is suspended by a rope. The

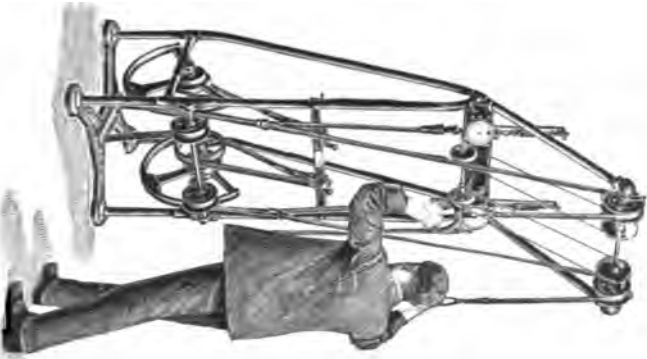

EXERCISES FOR PULLING.



EXERCISES FOR ROWING.

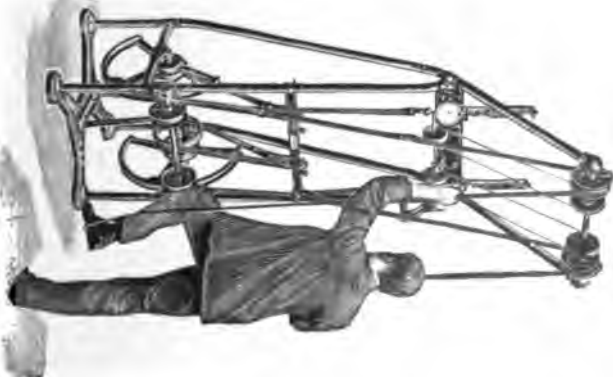

EXERCISES FOR CLIMBING.

APPARATUS FOR A VARIETY OF MOVEMENTS (PULLING, ROWING, CLIMBING, ETC.)

The dials indicate the exact amount of work done.



The importance of good judgment on the part of the physician must again be emphasized. The danger lies in over-doing things, especially at the start. The patient's organism, especially the heart, must be educated by steady and careful training, first to become tolerant to exercise of this kind, and secondly to gain strength functionally and structurally while apparently sacrificing energy.

Vibration.

Vibration (from the Latin *vibrare*, to tremble) in its finest form is the manner in which all force in nature becomes manifest. Matter proclaims its existence through force-manifestations. The latter are, in and of themselves, only varieties of vibratory movements. Sound is vibration, light is vibration, electricity is vibration, organic function is vibration, nerve-energy is vibration, thought is vibration, life itself is vibration. There is no life without force, no force without vibration. Vibration is the elementary basis of all biology.

Vibration in its coarse form means the act of imparting a more or less intense trembling motion to an object, *e. g.* the tissues of the human organism. In the application of manual therapy the practice of manual vibration was, up to within a comparatively recent period, considered of much importance. Masseurs cultivated marvelous skill in administering digital or manual vibration. Since the introduction of the mechanical device known as the vibrator, the practice of vibration by hand has become almost obsolete. The vibrator performs the act of vibration so much more perfectly and conveniently that manual or digital vibration can well be ignored in a discussion of the subject of vibration. The vibrator needs no introduction or recommendation. Vibration has without a doubt become more popular than any of the mechano-therapeutic modes of application. From the exalted plane of the scientific physio-therapist down to the more commercial level of the progressive tonsorial artist, vibration enjoys an undisputed degree of popularity. The

genius of the American mechanic and manufacturer has made its employment simple and agreeable. Patients are being vibrated for every ill to which human flesh is heir. That the universal practice of vibration should involve a great deal of amateurish empiricism, is not surprising. Like all fads in medicine it is "being worked to death." The attempts which have been made by some manufacturing concerns to make vibration a complete system of medical practice and, under the cover of a great deal of pseudo-scientific literature, sell a good many vibrators at exorbitant prices, have injured the cause of vibration as a therapeutic agent. The success of osteopathy, more than any other factor, suggested this systematizing of vibration as a cure-all, the vibrator taking the place of the osteopathic operator's hand.

There are many good vibrators on the market. If the mechanical construction of a vibrator is such as to impart the vibratory impulse to the tissues of the patient and not to the hand of the operator, it is a point in its favor. There is no doubt that the vibrator is a therapeutic agent of great potency. Its use should, therefore, be preceded by an approximately correct conception of its possibilities, physiologically and therapeutically. The modern instrument used for generating and imparting vibration is usually operated by an electric motor. Considered in conjunction with the instrument which produces it, vibration is in reality but a succession of strokes which follow each other more or less rapidly. These strokes may be long or short, severe or faint, and determine the depth of the vibratory impulse on the tissues. In response to these strokes every molecule within the sphere of the vibratory impulse trembles, the intensity of the response depending on the relative distance from the source of the vibratory movement. This, then, is vibration. What is its physiological and therapeutic effect when applied to the tissues of the living organism?

As has been stated before, the simplest and most elementary form of a stimulus is contact. Any organic substance which is at all capable of being stimulated, will re-

spond to mere contact with any object. Ciliary motion, amœboid movement, etc., are stimulated by mere contact. Stimulation is more powerful if contact becomes more firm. In this case contact would be in the nature of pressure. If pressure is sudden and abrupt, we would call it a stroke or a blow. A succession of strokes would be vibration. Thus we are prepared to look upon vibration as being primarily a stimulus. It is a stimulus, using the latter word in the same sense in which we applied it to massage. It increases, quantitatively and qualitatively, the local circulation. It tones up the arterial coats, and by increasing the arterial circulation and thus improving the nutrition of the part, it stimulates excretion and absorption of waste-products and corrects metabolism. The pulse becomes fuller and slower. We can readily understand why it is indicated in passive congestion, especially when pain is present (torticollis, chronic rheumatism, lumbago, neuralgia, etc.). It causes disintegration and absorption of low forms of tissue (obesity) and stimulates the heart, if directly applied to the precordial region. It stimulates activity by increasing the tone of muscular structure (constipation). Its local physiological effect corresponds accurately to that of massage. For this reason the term "vibratory massage" is entirely proper and adequate. Vibration and manual massage form a very excellent therapeutic combination.

The use of vibration as a species of local massage and the adaptation of the osteopathic idea of reaching the different parts of the body through the central nervous system (spinal cord), has given rise to the division of vibration into two varieties, *i. e.* *peripheral* (local) and *central* vibration.

If the vibrator is applied to an aching part, for instance to the muscles of the neck in a case of torticollis or to the muscles of the back in a case of lumbago or in the rectum for the cure of constipation or to the course of an aching sciatic nerve, vibration would be *peripheral* or local. It resembles the local application of massage. Whatever has

been said about the local effect of the latter, can be repeated, in a measure, concerning the local action of vibration. There seems to be no doubt that its primary effect is produced on the peripheral nerves, the vaso-motors, and that the subsequent local phenomena follow in physiological sequence. The direction, frequency and intensity of the stroke must not be lost sight of. It is of some importance, at what angle to the surface the vibratory force explodes, what degree of energy is spent, how often the stroke is repeated, how large the diameter of the vibrated area is and how much pressure is made by the operator's hand. On general principles it may be said that the stimulating effect on the deep tissues, *e. g.* the deep muscles of the back in a case of lumbago, is in direct proportion to the relative intensity or depth of the vibratory stroke and, in conjunction therewith, to the relative diameter of the surface treated. Likewise it can be stated that the greatest action is produced by a downward stroke, *i. e.* at right angles to the surface. The lateral stroke, *i. e.* parallel to the surface, stimulates the skin and its component parts. It is but fair to state that while all these points are of value in a clinical sense, the technique of vibration has by some been burdened with a mass of detail altogether out of proportion to the relative value of vibration as a therapeutic agent. The monomania of the optimistic enthusiast and mercenary instincts of the overanxious manufacturer who insists upon making a complete medical system out of a therapeutic method, are equally to blame. The former lacks exact knowledge and the latter conscience. A medical subject without critical knowledge to purify its theory and conscience to sanctify its practice, is indeed a miserable make-believe.

The greatest therapeutic benefits are supposed to be derived from the vibratory stimulation of the spinal nerve-centers whereby peripheral effects are produced in the regions controlled by the vibrated centers. This is the form of vibration previously referred to as *central* vibration. I shall endeavor to present the subject in keeping with the

clinical evidence which my own experience and that of other observers has adduced in support of this attractive form of drugless medication.

Let us for a few moments recall some salient points concerning the anatomy and physiology of the spinal cord and its adnexa. The spinal cord is contained in the vertebral canal, the latter being formed by the so-called spinal foramina of the individual superimposed vertebræ. The cord has the form of a flattened cylinder. On its anterior surface, in the median line, it has a narrow, deep depression known as the *anterior median fissure*. On its posterior surface it has the *posterior median fissure*, which, however, is not as deep as the anterior. On either side of the anterior median fissure are the points where the anterior roots of the spinal nerves emerge. The posterior roots of these nerves emerge on either side of the posterior median fissure. If, in a cross-section of the cord, we draw imaginary lines from the points of origin of the anterior nerves to the points of the origin of the posterior nerves on the opposite, we divide the cord into four distinct sections, which, as component parts of the cord, are known as the columns of the spinal cord. There are two lateral, an anterior and a posterior column. The bony framework which surrounds the spinal cord is composed of the so-called vertebræ (seven vertical, twelve dorsal and five lumbar). The vertebræ are separated from each other by the intervertebral cartilages and are placed one above the other. They are provided with foramina, processes, etc., for the accommodation or attachment of muscles, ligaments, blood-vessels and nerves. The anterior and posterior roots of the spinal nerves unite and emerge through the two intervertebral foramina, and supply through their numberless ramifications all parts of the body. Before the union of the posterior and anterior roots of the spinal nerves takes place, each posterior nerve develops a so-called *ganglion* (a knot-like expansion of nerve-tissue, largely composed of gray matter), which is of oval form, of reddish color, and is located near the inner margin of the interverte-

bral foramen. These ganglia are central nervous systems on a small scale; they are, as it were, sub-stations of nerve-energy. The physiology of the spinal nerves rests upon the general law first announced by Bell, that the *anterior* roots control *motion*, whereas the *posterior* roots control *sensation*. Nerves that communicate with each other form what is known as a *plexus*. It is of great clinical value to remember the exact location of the more important nerve-ramifications of this kind.

Two cords of nerve-tissue extend from the base of the skull to the coccyx symmetrically on each side of the vertebral column in front of the so-called lateral processes. These two cords are studded with numerous ganglia which represent distinct centers of nerve-energy, and from which and to which branches pass in diverse directions. These vertical cords, running from the base of the skull to the coccyx, with their many ganglia and branches, are what is called the *sympathetic* nervous system. Its fibers communicate with the spinal nerves, supply the numerous arteries nourishing the ganglia and pass to the organs of the thorax, abdomen and pelvis, forming many important plexus.

In addition to the motor and sensory spinal nerves and the ramifications of the sympathetic, there are some of the *cranial nerves* that are accessible to manipulation after they have emerged from the cranial cavity where they originate.

The fundamental idea of all osteopathic and central-vibratory manipulations is to preserve or restore the fountain-head of all life-energy, *i. e.* the roots of the nerves that control all evidence of vegetable and trophic activity in the organism. Such preservation or restoration consists in regulating the nutrition (circulation) in and near the nerves, ganglia and plexus, and to correct deviations from the normal as far as the surroundings of these nerves are concerned. All disease is supposed to be due to lack or perversion of nutrition of these nerve-structures or to changes affecting the soft and hard tissues surrounding them. The

vertebræ may be in faulty apposition, causing the intervertebral foramina to be changed in size and contour. This would cause pressure on the structures (vessels, nerves) passing through these openings. The result would be evidence of disease in the part or parts of the organism which are controlled by the affected nerves. Anatomical research has revealed the frequency of deviations from the normal anatomical standard of the spine. From the number of abnormal spines it would almost seem as though the normal spine was purely a theoretical ideal. This fact furnishes the plausible basis for a system of pathology that recognizes no disease or diseased condition except inasmuch as it is secondary or sequential to changes in or near the spine and its adnexa. The fact that such changes might give rise to peripheral disturbances and that removal or correction of the central lesion might sometimes result in a cure of the "disease," is the basis of osteopathy and, in imitation thereof, of so-called "vibratory stimulation." To the mind of the osteopathic optimist the probability assumes the hopeful appearance of an actuality and he proceeds to erect upon this interesting and attractive generalization a system of medicine as complete and scientific as any medical mind could wish for. It would all be well, if the premises were sound and logical. That the osteopathic pathology explains much that we never dreamt of in our philosophy, there is no doubt. That osteopathy opened up a neglected field of clinical research, can not be denied. That osteopathic manipulations frequently produce results that fairly stagger the drug-dispenser, no one who is well informed will attempt to question. But it is likewise true that osteopathy is a generalization from limited premises and that it is bound to fail in many cases because the principle is insufficient. The same—*cæteris paribus*—holds good in regard to systematic vibratory stimulation.

The therapeutic effect to be produced should suggest the technique of vibration. From previous considerations we know that mere contact is the simplest form of stimulation.

If we add pressure up to a certain degree the stimulating effect is enhanced. Continued firm pressure finally tires a nerve and a sedative action is the result. If we continue firm pressure beyond the sedative dose, the activity of the nerve is suspended, *i. e.* inhibition of nerve-function takes place. Since vibration is a form of interrupted pressure, we may reasonably assume that effects analogous to those of continued pressure can be produced. That *rhythmical* interruptions are in themselves capable of exciting nerve-action, is plain. Thus, we may summarize the effect of central vibrations in the following classification:

1. Mild Stimulation (very short strokes);
2. Powerful stimulation (deep strokes);
3. Suspension of nerve-activity from overstimulation (long-continued deep vibration).

CENTRAL STIMULATION is a subject worth investigating. We are still at the threshold. It behooves any and all of us to investigate carefully and help in the elaboration of this new and promising field of physio-therapeutic work. I will attempt to give the general landmarks of the subject as far as our knowledge of neuro-physiology and actual experience in central vibration justify any statements.

Theoretically, the idea of acting upon pathological conditions through the central nervous system or, to be more correct and explicit, through the sympathetic nervous system is in perfect harmony with the pathological view which looks upon all diseased conditions as being either due to over-nutrition (hypertrophy, inflammation, catarrh), under-nutrition (atrophy, degeneration), or perverted nutrition (ischemia, toxemia in the widest sense, abnormal cell-formation). At all events, the essence of disease is thought to be some disturbance of local or general nutrition. Since, however, nutrition is practically synonymous with blood-circulation, the idea of controlling (increasing, decreasing, altering) local nutrition resolves itself practically into the idea of controlling (stimulating, depressing, changing) the circulation in an affected region. The sympathetic nervous

system is, to all intents and purposes, the auditing office of the commissary department of the organism. It controls the supplies furnished to the different parts of the body. The sympathetic ganglia and plexus represent chiefs in charge of the supplies of special departments. These heads or chiefs have clerks under their control who look after the supplies of small portions of the region superintended by the chief. For example: The sympathetic plexus that controls the nutrition of (circulation in) all the abdominal viscera is known as the solar plexus. From it are derived ten smaller nerve-plexus, known as the phrenic, cœliac, gastric, hepatic, splenic, supra-renal, renal, superior mesenteric, inferior mesenteric and spermatic plexus, whose sphere of control is suggested by their names. To stimulate the solar plexus means to increase the nutrition of (circulation in) all the abdominal organs. The synonymous character of "circulation" and "nutrition" is suggested by the terms "vaso-motor" and "trophic," which are likewise synonymous and refer to the sympathetic nervous system. The "vaso-motor" nerves are the "trophic" nerves. Both names are interchangeable with "sympathetic" nerves.

The function of the motor and sensory nerves is controlled by the sympathetic nervous system. The degree of their functional capacity is determined by the nutrition of their fibers and ganglia. Mal-nutrition of motor and sensory nerves means corresponding impairment of motion and sensation in the areas supplied by them. Destruction of these nerves means suspension of motion and sensation. The lymphatic vessels and glands, the heart, the lungs, the skin, in fact any and every part of the organism is controlled by and, therefore, can be reached and acted upon through the nervous system. This is the basic theory of central vibration. For the practical application of the principles involved the following classification of spinal centers or regions might be of some service.

Vibration over the *cervical vertebrae* (in the median line or on either side of the median line in the intervertebral

spaces) is capable of causing impulses to be communicated to the motor, sensory and vaso-motor nerves supplying the head, neck, arms and of the body as far down as the diaphragm. It will be remembered that the cervical plexus is formed by the anterior divisions of the four upper cervical nerves, the brachial plexus by those of the lower four. In the sympathetic nerve-supply of the neck are some of the most important centers and ganglia, controlling (stimulating, inhibiting) the blood-supply (nutrition) of the head and brain. Respiration and the function of the heart can be influenced through vibration in this region. At the sides of the neck the phrenic nerve (coming from the cervical plexus and supplying the diaphragm) and the vagus (from the eighth pair of cranial nerves) which supply motion and sensation to the organs of voice, and motion to the pharynx, œsophagus, stomach and heart, are accessible to vibration.

VIBRATION-TABLE FOR CERVICAL REGION.

Circulation (face, head, brain) }	1. to 6.	cervical vertebræ.		
“ (general) }	1. to 6.	cervical vertebræ.		
Eye,	1. to 3.	“	“	
Heart (muscular tone),	1. to 5.	“	“	
“ (rhythm),	2. to 4.	“	“	
Ear,	6. to 7.	“	“	
Organs of voice (larynx etc.),	1. to 3.	“	“	
Mechanism of respiration,	3. to 5.	“	“	
Thermic centers,	2. to 5.	“	“	
Glands (lower jaw),	2. to 3.	“	“	
Diaphragm,	3. to 5.	“	“	
Plexus (cervical),	2. to 4.	“	“	
“ (brachial),	5. to 7.	“	“	

There are twelve *dorsal vertebræ*. They practically represent the location of sympathetic centers and ganglia which control the functions of the organs of digestion and assimilation. It is through vibration along this region that we can influence the splanchnic nerves and above all the great solar plexus. In moderately well-nourished or thin persons, vibration through the abdominal wall is capable of

affecting the nerve-tissue of the solar plexus and its branches. The motor nerves of the lower extremities originate in the dorsal region. We must not lose sight of the fact that the fine interlacement of nerve-fibers establishes many direct paths toward distant nerve-centers and ganglia, so that many subsidiary ganglia are found in the dorsal region that are connected with the important ganglia in the cervical region and, as it were, serve as sub-stations. Thus we find quite a few sub-ganglia from the second to the seventh dorsal vertebræ that share in the control of the mechanism of respiration.

VIBRATION-TABLE FOR THE DORSAL REGION.

Stomach,	3. to 12.	dorsal vertebræ.	
Relaxation of pylorus,	4. to 5.	"	"
Liver,	9. to 12.	"	"
Pancreas,	8. to 9.	"	"
Spleen,	8. to 11.	"	"
Intestines (small),	1. to 10.	"	"
Peristalsis,	9. to 11.	"	"
Chill-centers (connected with thermic ganglia),	7. to 8.	"	"
Kidneys,	6. to 12.	"	"
Diaphragm (through phrenic fibers of solar plexus),	11. to 12.	"	"
Lymph-circulation (through splanchnic nerves),	5. to 12.	"	"
Lower extremities,	2. to 12.	"	"

The remainder of the vertebral column is made up of five lumbar vertebræ, the sacrum and coccyx. The nerve-ganglia and plexus in this region control principally the functions of the large intestines and of the genito-urinary apparatus. An important thermic sub-ganglion is situated near the fifth lumbar vertebra. The nerve-centers controlling the sexual function in both sexes are distributed over the whole lumbar region and are closely connected with similar centers situated near the three lower dorsal vertebræ. It is of interest and importance to remember the universal distribution of ramifications of nerve-fibers which directly and indirectly connect with the sex-centers and are closely interwoven with the nerves of the skin. It is well

CHAPTER VI.

FORCE AND FORCE-MODALITIES.

THE true student of nature is not satisfied to merely observe the phenomena of activity around and within him. He inquires into the reasons of things and tries to establish the connection between causes and effects. In attempting to do so he is obliged to analyze the manifestations of activity and find the laws which govern them and the manner in which these laws operate. He knows that nature represents the sum-total of the things that are. He is aware that these things possess certain properties which determine and influence their relations to their surroundings, and that these properties are the manifestations of force inherent in the things that are. He knows that the things that are, represent matter in different states of aggregation and composition and necessarily possess inherent energy. To him existence means the mutual relation of matter and force. Thus the study of this relation is in reality the very essence of natural philosophy.

That which we call "light" is an evidence of some activity. The energy inherent in that compound of matter which we call "sun" becomes manifest and is perceived by that compound of matter which we call "organ of sight." This evidence of activity begins and ends with a manifestation of energy inherent in matter. The two compounds of matter assume a certain relation to each other. This relation must affect other existing things which are interposed between one compound and the other, between the sun and the eye. This relation is real, not a figment of the mind, not an illusion. That which is interposed between

Oscillation.

Oscillation in variable degrees of intensity is practiced manually by masseurs. It is really an exaggerated form of vibration. It means a violent shaking up of a part, *e. g.* the abdomen, by the hand of the operator. Oscillation is nowadays practiced with the aid of a specially constructed instrument, called an "oscillator." The physiological effect and therapeutic indications are similar to those of other forms of mechano-therapy, notably Swedish movements and peripheral vibration. It manipulates the tissues *en masse* by a violent and indiscriminate shaking up. It is an excellent muscular tonic and can be frequently employed with advantage in breaking up adhesions and stretching contracted tissues. Oscillation of the whole abdomen is a splendid auxiliary in the treatment of habitual constipation. A thorough understanding of the principles of massage and vibration will enable the operator to employ oscillation at the proper time and in the proper way.

In conclusion let me again say that the possession of a vibrating or oscillating instrument should not be a reason for employing vibration and oscillation indiscriminately in each and every case. Never lose sight of the indications in each case and the limitations to the use of vibration and oscillation. Beware lest you become a fanatic in theory and a buffoon in practice. Always try to comprehend the purpose, to understand the means, and to adapt the latter to the former intelligently. *Quidquid agis, prudenter agas et respice finem!*

being its mode of transmission. There is no limit to the variety of oscillatory and undulatory motion of the ethereal molecules. The oscillatory movement may be more or less rapid, may be fine or coarse. The undulations may be slight or well-marked, may be long or short. This gives us the concept of *wave-length* or the length of the series of molecules which is set in motion by an impetus before the latter is received by the next series.

It is this variation of ethereal oscillation and undulation which modifies the manifestations of inherent, crude, elementary force and gives them the specific character of light, sound, electricity, heat, etc., etc. All these manifestations of activity transmitted by the ethereal molecules are modalities of the original *elementary force*. In this sense we speak of light, sound, etc., as being *force-modalities*. They are not forces but modalities of the same elementary force, the modifying element being the motion of the ether molecularly and serially. This conception of force and force-manifestation furnishes the only plausible explanation of the phenomena of light, sound, heat, electricity, radio-activity, magnetism, animal magnetism and suggestion. It brings these diverse forms of activity under the general head of force-modalities.

The modus operandi of force-transmission is easily understood. The impetus which emanates from matter in the form of a manifestation of energy is carried from molecule to molecule, from series of molecules to series of molecules, the manner of molecular oscillations and serial undulations giving to the impetus a specific character, *e. g.* light, sound. If a stone is dropped into water, the impetus communicated to the body of water will be seen to travel through the latter, giving rise to circular waves, emanating from the center and traveling towards the periphery. A cork dropped into the water will not be carried along by these waves (undulations), but will bob up and down. This example is to illustrate the idea of force-transmission through a medium which—as a whole—remains stationary. The molecules of

water move, but their motion is a vibration or oscillation around their normal point of rest as a center. These molecules move and gradually return to their position of rest. If a rope is suspended and the lower end is given a sudden jerk, the impetus will be seen to travel upward in the form of waves formed by the rope. The rope is relatively stationary. The impetus travels. Vibration of the molecule means motion around a given *point* of rest. Undulation of a series means motion around a given *line* of rest.

Force is eternally and universally one and the same. It only differs in its modalities. Matter can likewise be considered eternally and universally one and the same. It only differs in its states of aggregation. Ether permeates space, even the space occupied by matter whose state of aggregation is such as to be perceptible by our organs of sense, *e. g.* a piece of lead which is seen and felt. The state of molecular aggregation of matter must necessarily affect the molecular ethereal vibrations within it. If an impetus has been received and is being transmitted by the molecules of ether, the vibrations of ethereal molecules can not help being impeded to a certain extent by the gross or macroscopic media which the ether permeates, *e. g.* air, smoke, wood, metal or any kind of matter which may be within the path of ethereal oscillations and undulations. These interposed media may serve as obstacles, *e. g.* a layer of lead to the X-rays, or as conductors of force-transmission, *e. g.* glass as a conductor of light, copper as one of electricity. The physical attributes of matter which give to the latter its power of conducting, altering, intercepting these vibrations are not clearly understood, although, as suggested before, the state of aggregation of matter seems to give to the latter its relative fitness as a conducting or intercepting medium for different kinds of force-modalities. One state of aggregation may not offer any resistance to one form of molecular vibration, *e. g.* a piece of cloth to the X-rays, while it will completely arrest vibrations of another kind, *e. g.* vibrations of light from the solar spectrum. Certain interposed media may completely

stop vibrations of sound, *e. g.* a brick wall, while they would not interfere at all with the force-modality emanating from the generator of a wireless telegraph-instrument. These points seem trivial upon first sight. Closer investigation will reveal their importance as auxiliaries in the solution of many an occult physical problem.

"Force," says Moleschott, "is the necessary property of matter, inseparable from the latter and inherent in it from the very beginning." Matter everywhere is, as it were, charged with it and constantly, under given favorable conditions, proves the presence of force. Matter possesses at all times the property of communicating impulses to the ether and causing these impulses to be carried by vibrating ethereal molecules. The latter give rise to different force-modalities. The change of elementary force into a special force-modality and the change of one modality into another are generally admitted scientific facts (*Kraftumwerthung*). Thus the elements of one modality are the elements of every other modality. Magnetism is converted into electricity, into X-ray radiations, into light-phenomena, into heat and so on. It would carry me beyond the confines of my subject to refer, even in a brief way, to the physiological possibilities of this view of force and force-modalities. That the sum-total of energy present within our solar system is in reality reflected sun-energy, that the sun is the original source of all force, is not altogether improbable. This view would furnish a modern scientific basis for the ancient sun-cult of Zoroaster. It would be in accord with the chronological events of the creation as related in the Genesis. The first act of creation refers to the sun upon whose physical activity the existence of all other things depends. From this heliologic point of view the energy of matter is reflected sun-energy or a charge received and re-supplied by the activity of the sun (*helio-pantheism*).

Since force is that property of matter by which matter keeps the ethereal molecules in a state of agitation and since matter without this constantly active property can not be

conceived, we are prepared to consider *all matter necessarily in a state of radio-activity*, meaning by the latter term the property of imparting impulses to the molecules of ether by which the latter are made to oscillate and undulate. The force-modalities of an excited X-ray tube or of radium are coarse illustrations of radio-activity. There is no doubt that millions and millions of different force-modalities are constantly active without us and within, too fine for our coarse senses and means of investigation to discover. We have hardly learned the alphabet of this wonderful subject. We know nothing concerning the radio-activity of the human body and of every molecule within it. The neuron (nerve-cell) is radio-active and causes impulses to be communicated to the ethereal molecules. Within the range of this ethereal oscillation there is some particle of matter, some nerve-cell, some neuron whose state of aggregation and composition qualifies it to respond to these ethereal oscillations, just as the ear responds to sound, the eye to light. Thus the second neuron vibrates in harmony with the first. What more plausible explanation can be given of the phenomena of telepathy and suggestion? What else can thought be except a form of radio-activity of brain-cells? In no other way can mental or psychic phenomena (memory, consciousness, dreams, etc.) be explained.

It can no longer be doubted that every molecule of the human body possesses some form of radio-activity. How many different forms of radio-activity the body possesses, what relative degree of radio-active force is present in different molecules, what influences may affect the quantity or quality of radio-activity, whether there is but one complete force or a duality of forces (positive, negative), what the relations of these dual elements are,—all these questions are open and will remain so for some time to come. That certain radio-active forces exist in the body and give rise to strange phenomena, is admitted on all sides. Not very long ago I saw a radiograph which had been produced by the radiating energy from the hand of a so-called mag-

netic operator. The photographic sensitive plate was placed in a black and yellow envelope and put on a table. A key was deposited on the outside of the yellow envelope. For twenty minutes the operator held his hands over the plate, the tips of the fingers pointing towards the key. The plate was developed in the ordinary way and showed a faint radiograph of the key. The room in which the experiment was made was dark. The magnetic or radio-active force emanating from the man's hands is just as real as the radio-activity of an X-ray tube or of radium. I dislike the word "animal magnetism" because it savors of charlatanism. It is not an illusion or a deception, however. It suggests a form of physical energy which we are unable to account for, although the effects of its activity can be seen everywhere. The phenomena of individuality, genius, talent, suggestion, hypnotism, telepathy, love, passion, maternal or pre-natal impressions, heredity, idiosyncrasy and temperament must be classified under this head.

For the sake of illustration I beg to quote a few examples without, however, attempting to classify them or account for them. A sleeping person can be awakened by some one looking at him or pointing at him even in a dark room. Moll reports the case of a young lady who had lost over twenty pounds in weight in less than six months. There was no other indication of anything being wrong. She was a blonde with soulful blue eyes and a most amiable disposition. Upon inquiry it was ascertained that for six months she had slept with her younger sister, a brunette with snappy black eyes and a very positive disposition. The younger sister happened to be sent off to school and slowly but surely the older one regained her weight. Similar cases, especially among married people, have frequently been reported. Children often show a dislike for some strange person, there being no apparent reason for such dislike. The touch or the handshake of some people is distasteful. Even the lower animals are affected by these mysterious forces. The old adage, "Speak of the devil and he is sure to appear," has reference to the appearance of a person who

is just being spoken of. It can be explained on the basis of ethereal oscillations. Presentiments, premonition and the telepathic influences of mind over mind likewise become intelligible if explained on the ground of radiation.

That the body radiates heat, is plain. That it has a phosphorescence of its own and throws out rays (n-rays) resembling those of light, is believed by many. The influence of rays of short undulation and very rapid oscillation (ultra-violet field of the solar spectrum) on the sex of plants and animals is a strange biological phenomenon.

What bearing has this theoretical discussion of force and force-modalities on the practical application of Physiological Therapeutics?

In order to understand light, electricity and other physical agents and their relations to each other, it is necessary to try and get a glimpse, however faint, into Nature's workshop. That the greatest achievements along physical and biological lines are still to come, there seems to be no doubt. It behooves us to sharply define our concepts of radio-activity and its place in nature because it is the connecting link between matter and force, as we are at this late day prepared to admit. Suggestion is a subject which physicians usually avoid; yet it is of overtowering importance, and should, therefore, be freed from the ballast of misconceptions and quackish notions with which it is encumbered. It should be studied and worked out like all other problems in natural history. The same might be said about somatic radio-activity (animal magnetism) which is a physical reality and offers an almost boundless territory for research and experiment, even in a therapeutic direction. By solving these problems we will get closer to the true inwardness of life, of nature, of our own place in the vast domain of existing things and might lift the veil that hides the Whence? Where? and Whither? from the eyes of mortal man. The acquisition of knowledge for the improvement of our fellow-men, or even for the sake of possessing knowledge, is the one ideal that makes life worth living.

CHAPTER VII.
THE THERAPY OF LIGHT.

"Water is great; air is greater; but the greatest of all is light."—PETTENKOFER.

*"Light is indeed a priceless gift of heaven.
It is the life of every living thing."*—SCHILLER.

"Mehr Licht!"—GOETHE.

AMONG the many brilliant achievements of modern scientific medicine the therapy of light occupies a commanding position. Even the immortal work of Roentgen has not been able to obscure the brilliancy of the labors done by Finsen and his pupils. The practical results accomplished by the scientific application of rays of light have gained for these methods a high and undisputed place among the therapeutic resources of to-day. In view of the fact that we have not as yet advanced beyond the threshold of this era of great achievements, it behooves us to add our mite to the sum-total of knowledge and experience and thus help in the elaboration of the vast possibilities which the subject offers. Among the various physical or mechanical therapeutic agents known to modern medicine *light* is, in point of clinical usefulness and therapeutic efficacy, surely entitled to a foremost place. Together with water and air it represents a disease-preventing and disease-curing factor of overtowering importance. It is one of the elements without which life is impossible. Upon this point all scientific men are agreed. Not all physiologists, however, seem to realize that the hygienic importance of light is not greater than its curative power. This is a categorical statement

which I hope to demonstrate if only to stimulate thought along the lines of rational therapeutic methods.

In considering light as a health-preserving and health-restoring factor, it behooves us to, in a general way, try to understand its enormous importance in conjunction with different phases of physical life, and more especially to appreciate its influence upon those changes in the animal economy which are included under the head of "Metabolism." If the absence of light is capable of causing disease, it is not unreasonable to assume that the presence of light will prevent disease. We may begin our reasoning by stating that the human body requires light for its sustenance. The most vital of all physiological processes, namely respiration, both cutaneous and pulmonary, is directly affected by the presence or absence of light. The quantity of oxygen which is taken up by the tissues is directly dependent upon the relative amount of light to which the body surface is exposed. During the day the human body takes in more oxygen and excretes a relatively greater amount of carbonic acid. This is due partly to the increased amount of oxygen in the air during the day, partly to the greater receptive and assimilative power which the body possesses under the influence of light. When the sun, the great source of light, approaches the horizon and leaves the world to darkness and to the analyzing physicist, it seems as though all nature were lulled to sleep. Its voices are hushed, and man and beast are slowly rocked to rest in the cradle of universal silence. The evidences of activity gradually disappear. Darkness supervenes, and with it a desire to rest becomes manifest throughout the living creation. The human organism, which is a part of the living creation, shares in this general depression of vitality. Its machinery works under lower pressure. Physiological respiration becomes more superficial, assimilation less active and excretion more sluggish. The more finely organized the structure, the more characteristic the change which comes over it in the absence of light. Only the lower form of life, the fungi and other forms of

micro-organisms, thrive, their greatest antagonist, light, having temporarily withdrawn from the field of contest. In view of all these facts we can readily understand that conditions which are due to perverted metabolism or produced by the action of bacterial life, are necessarily or intimately dependent upon the presence or absence of light.

The researches concerning the biologic importance of light in conjunction with the functions of the human organism have indeed revealed many interesting facts. It has been shown that light will affect the contractility of protoplasm. The red blood-corpuscles, the direction, speed and duration of the movements of certain infusoria and diatoms are directly influenced by light. The muscular excitation and activity of frogs has been shown to be much more energetic under the influence of light than in the absence of light. It has been proven that the quantity of coloring matter in the red blood-corpuscles increases and decreases in accordance with the amount of light to which the animal body is exposed. That light is fatal to bacterial life, had been suspected by many observers long before the time of Finsen. As far back as 1870, Esmarch exposed his surgical instruments to the rays of the sun for the purpose of disinfection. Light, in fact, occupies the position of the universal disinfectant because without it the purification of river water would be inconceivable. There is no longer any doubt that the pathogenic bacteria are affected by the action of light. Geisler exposed a culture of typhoid bacilli to the light of a thousand candle power arc-light and after three hours of illumination the growth of the culture had been practically suspended. Aufrecht inoculated various animals with the bacilli of Milzbrand, diphtheria and tuberculosis. The inoculated animals which were kept in the dark died within two or three days. Those exposed to the light usually resisted the effects of the inoculation. The beneficial effect of light as a germicidal factor and an oxygenator is seen in cases of tuberculosis of the peritoneum in which an exploratory incision is frequently followed by distinct improvement.

In order to understand the therapy of light it is necessary to know something about the physics of light. If we cause the white light of the sun or of the electric arc-light to fall through a prism, the result is a splitting up of the light into its component rays. Technically the arrangement of the component rays of white light is known as the solar spectrum. It having been shown that the spectrum of the arc-light is practically identical with that of the sun, the difference in the light being one of intensity and not of kind, the physical and therapeutic attributes of the solar and arc-light can reasonably be supposed to be the same. Clinical and spectroscopic observations have confirmed the correctness of the supposition.

The seven different colors or rays of light are red, orange, yellow, green, blue, indigo and violet. These rays are known as the *visible* rays in contradistinction to numerous forms of *invisible* light-energy situated beyond either end of the spectrum (*infra-red* and *ultra-violet* rays). Some of the rays, notably those emanating from the red and more especially from the *infra-red* fields of the spectrum, produce heat and are, therefore, known as *thermic* rays. Other rays, particularly the yellow and green, are light-producers and are known as *luminous* rays. The rays of the blue, indigo, violet and more especially the (invisible) *ultra-violet* fields are capable of producing characteristic changes in the chemical composition of organic and inorganic matter and are commonly known as *chemical* rays. They are also called *actinic* rays. The most powerful chemical rays emanate from the *ultra-violet* field and are invisible. Let us remember once for all that the term "*ultra-violet*" refers to the spectroscopic location of these invisible rays and not to any particular color. The view held by some ill-informed physicians that *ultra-violet* means *intensely* violet or a *deep* violet, is therefore, manifestly absurd.

In the year 1893 Niels R. Finsen, of Copenhagen, Denmark, published the results of certain biological researches

in reference to the action of the different rays of the sun (or, for that matter, of the electric arc-light), more especially of the *chemical rays*, *i. e.* light minus the *thermic* and *luminous* rays. The effects of the chemical rays play a most important part in the life-process of the whole creation. They are the motive power by which the metabolism of the living world around us is made possible,—from the life process within the organism of the tiny insect to the regeneration of the vast bodies of water which carry the excreta of millions of people and yet furnish healthful drinking-water after the sunlight with its regenerating chemical rays has caused the messengers of decay and death to become carriers of life and health. The chemical rays are the most easily refracted rays. They are broken by the moisture and gases in the atmosphere and by the surface of the earth. The heat-rays are the least refrangible rays. Thus it is that chemical rays permeate the dark of night long after the heat- and light-rays of the sun have ceased to act. The fact that owls and cats see at night is attributed to the peculiar construction of their visual apparatus, which is acted upon by the chemical rays.

Finsen was not slow in applying the lessons which his studies had taught him. His first attempt to apply light to diseased processes and tissues gave the sanction of science to the empirical therapy of light which had been in vogue since the days of Hippocrates; they marked the birth of modern photo-therapy as an exact science with a vast sphere of usefulness. The first scientific fact which Finsen gave to the world as a result of close observation and study attracted universal attention to him and his work. It pertained to the scars of smallpox, which Finsen showed to be due to the disintegrating effect of the chemical rays of light. He reasoned that these scars could be prevented, if the patient could be protected against the chemical rays. By experiment he proved that the chemical rays will not penetrate red media, and proceeded to apply this fact practically by causing the windows of the sick-room to be painted red, by

causing the walls of the room to be covered with red paper, in fact by interposing red anywhere and everywhere in order to intercept the chemical rays. Finsen achieved his first triumph when the results abundantly proved the truth of his statement. The principle of the red-light treatment of smallpox can be interestingly illustrated by a very simple experiment. Take a piece of sensitized paper and place on it a piece of red glass. Expose the whole to the sun's rays



FINSEN'S DEVICE FOR CONCENTRATING AND COOLING THE RAYS OF THE SUN.

for a little while and it will be found that the part of the paper under the glass has remained unchanged while the rest of the paper has become rapidly discolored.

The marked germicidal action of the chemical rays prompted Finsen to apply them to infected skin. The classical example of a condition of this kind is lupus or tuberculosis of the skin. Finsen devised an apparatus which would be adapted to this purpose. He concentrated these rays by eliminating the heat- and light-producing rays from

the mass of light emanating from the generating source, which was either the sun or a powerful arc-light. By causing the light to fall through a sheet of water, all the heat-rays were practically absorbed, and the light was rendered cold. By adding methylene-blue, potassium permanganate or certain other coloring agents to the water, Finsen enhanced the effect of eliminating the red or heat-rays. At the same time he found that many of the light rays were lost. His idea was to get as compact a concentration of chemical (ultra-violet) rays as possible. These concentrated rays were condensed by means of a suitable lens, and were directed upon or against the affected part of the body. Finsen found by spectroscopic analysis that the ordinary glass lens was unavailable because glass absorbs the chemical rays either entirely or to a large extent. He, therefore, substituted lenses made of quartz or rock crystal, which allows the chemical rays to pass. He found by experiment that blood absorbs chemical rays. The experiment by which he established this fact is too clever and interesting to be omitted. Finsen's helpmate in his great work was his wife, who gladly offered herself as a subject for experiment whenever her distinguished husband, after experimenting on his own skin, desired further experimental proof for any of his investigations. Finsen placed a piece of sensitive photographic printing paper in direct contact with the posterior surface of his wife's ear. He directed a beam of chemical light to fall upon the anterior surface of the ear. No matter how long the exposure was continued, there was no effect on the paper. After placing the ear between two thin pieces of quartz, rendering it anemic by pressure, he repeated the experiment. The paper turned black within a few moments, showing that the blood had previously prevented the passage of the rays. This fact suggested to him the necessity of covering the part to be treated with a piece of rock-crystal in order to render the part bloodless. Finsen evolved step by step the technical details of the method which was destined to become so powerful a factor in the

treatment of a variety of conditions. The essential features of a Finsen apparatus, therefore, are: a source of chemical light, a large condensing lens to concentrate the rays emanating from the source, a water-receiver through which the light passes and in which it loses all its heat-rays, a small condenser to collect the chemical rays which have emerged from the water, and a pressure-crystal to render the skin anemic. These essential features are, to a larger or smaller extent, embraced in all the devices which have been constructed after the type suggested by Finsen himself.

Finsen's original type was open to many objections. In using the electric arc-light, Finsen constructed light-generators of tremendous power. He speaks of 80 ampere arc-lights. It is needless to refer to the clumsiness and dangers of such an apparatus. An equally justifiable objection is the fact that the peculiar construction of the original Finsen lamp involved great loss of light. Over 60 per cent of the light produced by the apparatus were lost. Finsen suspended the 50 or 80 ampere lamp from the ceiling, placing four or six telescopic tubes at an angle below the lamp, one patient being treated under each tube. It stands to reason that more than half the light of the lamp is lost in this way because only a comparatively small portion of the light is received by the tubes. A perusal of Finsen's book ("Ueber die Wirkung der concentrirten chemischen Lichtstrahlen") will show the principles underlying, as well as the imperfections involved in Finsen's original lamp. The heat-production of so high an arc is also a factor of some consequence, not to speak of the expense of constructing and maintaining the apparatus.

To make the Finsen idea practically available, many attempts have been made to modify, or rather to simplify, the original device. The best known modification is probably the portable Finsen lamp devised by Sequeira and generally known as the London Hospital Lamp. It is simple in construction, easy to handle, neat in appearance and possesses considerable therapeutic power. It furnishes a

cold light, the cold water constantly circulating in front of the powerful arc-light. Another very useful modification of Finsen's device is the hand-lamp invented by Kjeldsen, of Copenhagen, and known as the Dermo Lamp. Kattenbracker, of Spandau, used one of Kjeldsen's lamps for the purpose of studying the effect of light on germ-life. The lamp is held by the operator. It is supplied with hollow iron-electrodes, through which cold water constantly flows, rendering the light cold. The cone of light is small, but



LONDON HOSPITAL LAMP.

qualitatively powerful. Kattenbracker used the light from this lamp at a distance of 10 centimeters (arc 5 amp. 40 v. direct current). He used 15 p. c. nutritive gelatine as a culture-medium for gonococci and tubercle bacilli, 2 p. c. glycerine-agar covered with sterilized blood-serum for typhoid and other germs. The germs were grown in surface-cultures on plates at a temperature of 22 C. The control-cultures were kept at 35 C. to allow for the slight rise in the temperature of the light from the lamp. Inoculation from the rayed cultures on glycerine-agar was made after forty-eight hours and the new culture kept at a temperature

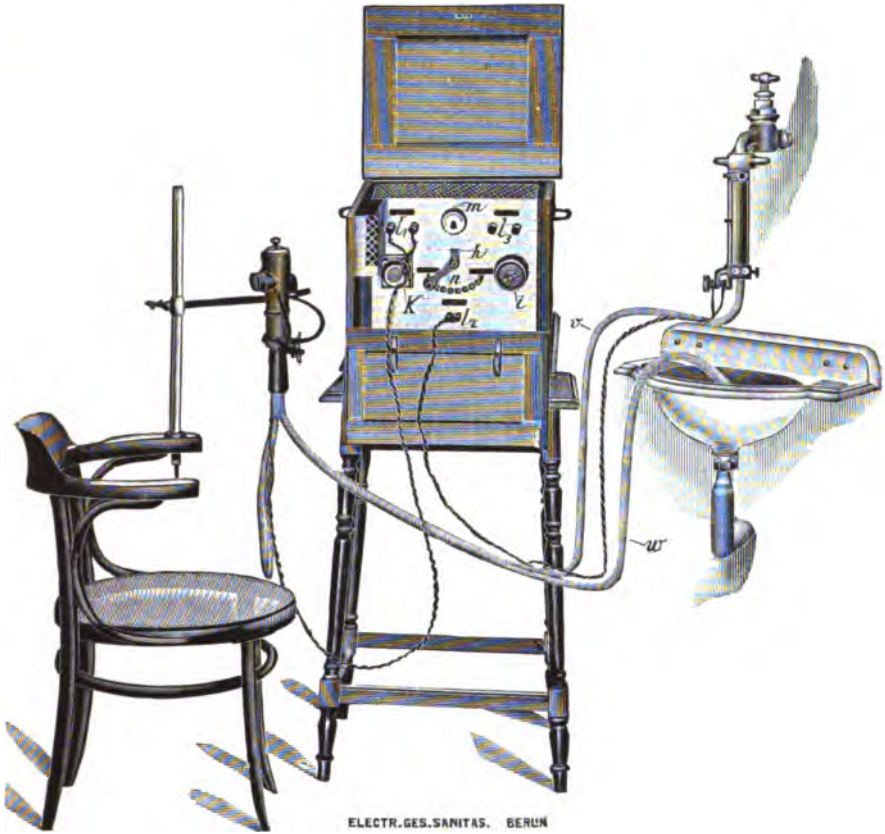

A "DERMO" EQUIPMENT.

v and *w* are the rubber tubes for carrying (supply and waste) water to and from the lamp. The electrodes are iron and hollowed out to allow the water to circulate. *h* is the handle of the current-controller (*n*). *i* is the current-switch. *k* is the fuse-box. *m* is the ammeter. *l* (1, 2, 3) is the current-supply. The wires from *l*₂ represent a loop in the circuit to prevent the formation of an arc in the lamp unless the water is flowing. The pressure of the water distends the rubber tube and by an ingenious arrangement completes the circuit.

of 35 C. for forty-eight hours. The relative viability of the new culture was taken as a criterion for the relative germicidal power of the light.

Typhoid Bacillus. After an exposure to Kjeldsen's light lasting one second there was no effect. After three seconds growth markedly impaired. After thirty seconds vitality almost suspended. After sixty seconds culture was dead.

Comma Bacillus. No effect after five seconds. Impairment after thirty seconds. Death after two minutes.

Tubercle Bacillus. Slight impairment after five seconds. Marked impairment after sixty seconds. Death after two and one-half minutes.

Micrococcus Gonorrhoeicus. Slight impairment after five seconds. Marked impairment after thirty seconds. Death after two minutes.

Bacterium Coli Commune. Impairment after thirty seconds. Death after two minutes.

Streptococcus Pyogenes. Impairment after thirty seconds. Death after three minutes.

Anthrax. Impairment after five seconds. Death after thirty seconds.

In the types of Finsen-lamps recently employed the luminous rays are not eliminated. Finsen's subsequent experiments have shown that exclusion of the light rays is not essential. I am even inclined to think that the presence of the light rays is not only not objectionable, but rather desirable. Light has a regenerating and germ-killing effect and likewise a strong affinity for oxygen. Its presence would, therefore, rather tend to enhance the action of the chemical rays. The principal thing is to get rid of the heat rays.

What is the physiological action of the *chemical* light? If a beam of concentrated chemical light is allowed to fall upon healthy skin, the eventual result will be an erythema followed by much local irritation, dermatitis, molecular death and desquamation. The tanning of the skin in the summer is the result of the deposition of pigment in the skin. Pigment is nature's safeguard against the destructive

action of the chemical rays, the latter being absorbed by it. Chemical light seems to affect the procreative function of plants and animals as far as the sex-production is concerned. Chemical light favors the production of males. The germ-killing power of chemical light has been proven beyond a doubt. It has a strong affinity for oxygen. It produces a disintegrating effect upon living tissues. The greater the resisting power of the tissues, the less intense will be the action of the chemical rays. Since morbid tissues are less viable than the normal, the destructive effect of the chemical rays upon the cutaneous tissues wherein tubercle-bacilli or other germs have found lodgment, can be readily understood. The treatment of lupus is the classical example of the physiological action of Finsen's rays. Their germ-killing power strikes at the very essence of the affliction. They stimulate healthy action by attracting oxygen to the part. The morbid tissues of the afflicted portion are disintegrated by the rays. In this way a healthy reaction is set up, which tends towards restoration of the normal condition. The consistent and persistent use of the Finsen lamp is indicated in all parasitic skin-diseases. Lupus, sycosis, tinea, certain forms of chronic eczema, psoriasis, disease of the hair follicles, furuncle, carbuncle, alopecia areata, etc., furnish a rich field for successful clinical work. What degree of clinical usefulness may be attributed to these rays in the treatment of internal diseases, we are not as yet prepared to say. That the body is practically translucent or can be made so, can not be questioned. It is needless to point out the enormous importance of this fact in connection with the possibilities which chemical light offers in the treatment of tuberculosis of internal parts, especially in cases of incipient tuberculosis of the apices of the lungs.

It may not be amiss to call attention to two interesting facts which seem to have been established through the biological researches of Finsen:

1. Pigment in the skin absorbs chemical rays. The more pigment in the skin, the smaller the amount of chemical

light which penetrates into the interior of the body, the less disinfection of the interior. Since anerobic germs thrive in the absence of light, we may reasonably suppose that the tendency toward tuberculosis is in direct proportion to the amount of pigment in the skin. The negro is notoriously a ready victim of the tubercle bacillus.

2. The plasmodium malariae becomes inactive in the absence of light. This has been shown experimentally. If light is excluded from the skin of a malarial patient, the malarial attack is modified or even aborted. This has been demonstrated by the darkness-treatment of malaria adopted by American army surgeons in Puerto Rico. The treatment consists in confining the patient in a dark room for many days. Corroborative evidence is furnished by the fact that malarial attacks hardly ever occur at night, and by the additional fact that the negro is practically free from malaria. (These conclusions are not altogether above criticism. See MALARIA.)

Let us not forget that the mechanical devices which—thanks to the genius of Finsen—have assumed so important a place in our therapeutic armamentarium, are at best but poor substitutes for Nature's own light-producer, the sun. Sunlight—that greatest and cheapest of all therapeutic agents—how little the average physician appreciates its curative power! The healthy human body needs it, the sick human body imperatively demands it. It is the beginning of hygiene in health and disease. It is a necessary condition of life under any and all circumstances. It is to the skin what oxygen is to the lungs. Life is impossible without either. In cases of tuberculosis pulmonum treatment is not complete unless sunlight is included. The skin performs a compensatory function for the disabled and impaired pulmonic apparatus. In all chronic diseases the importance of sunlight, especially the light of the morning-sun which is rich in chemical rays with a comparative scarcity of thermic rays, can not possibly be overestimated. In the times of Pericles the daily sun-bath was as much a necessary health-measure

as the ablution of the hands. This advanced and enlightened age of ours would do well to turn back to the days of Hippocrates and learn the eternal and immutable principles which in our busy evolution of a thousand unimportant details, we have no time to remember. The *helio-therapy* and *solarium* of the old clinicians served an admirable purpose and deserve to be revived wherever opportunity or space will permit.

The clinical uses of the *thermic* rays are suggested by the physiological action of heat. Wherever and whenever heat is indicated, the thermic rays will answer the purpose. The ordinary incandescent globe is a splendid source of dry heat and has recently risen to a high plane of clinical importance through the labors of Dr. A. W. Minin, of St. Petersburg, whose heat-reflector (blue incandescent globe of suitable candle-power in a parabolic reflector) is a simple and, withal, an extremely useful device. It is neat, simple, clean, easily manipulated and meets an almost endless number of clinical indications. It is more than the old-fashioned flaxseed poultice without the bulk, filth, labor, stench and other disagreeable features of the latter. The color of the globe is what gives to this light its pain-relieving action. Minin insists upon spectroscopic examination of the blue globes used, to make sure of the presence of a large percentage of blue light. The following points indicate in a general way the sphere of clinical usefulness which might reasonably be attributed to Minin's device:

The cutaneous hyperemia which follows an application of the thermic rays produced by Minin's device, stimulates the circulation of the area treated, unloads the veins, stimulates the function of the lymphatics, depletes the deeper structures and accelerates and intensifies local metabolism. In this way toxic material and inflammatory products are excreted or absorbed, the nutrition of the part is regenerated and a powerful impetus given in the direction of the restoration of normal conditions. The peculiar change in the appearance of an ulcer or an abraded surface which

has been exposed to thermic rays is due to the coagulation of the albumen which gives the surface an appearance as though a delicate skin had formed over it. We can readily understand the local anodyne action which follows an application of the thermic and the blue rays of Minin. They produce a soothing effect in all cases of contusions, bruises, strains, sprains, etc., etc., and are a powerful ally of the *vis medicatrix naturæ* in her efforts to restore the normal condition of things. In the treatment of chronic, indolent ulcers they are of great value because they increase the local activity, regenerate the parts by attracting fresh arterial blood and in this way stimulate granulation. The term "violet ray" is a misnomer because there are no violet rays contained in the light produced by Minin's device. All the effects which can be produced by the Minin apparatus are largely due to heat, and, for this reason, a recital of the clinical uses of the Minin apparatus would practically be a recapitulation of what might be said about the action of heat.

THE ELECTRIC-LIGHT BATH.

After all that has been stated concerning the uses of various forms of light we are prepared to understand and appreciate the importance and usefulness of a mechanical device which enables us to make practical use of all the various physical agencies which are included in light. The light of the electric arc has approximately the same spectroscopic composition as sunlight. The light of the incandescent globe is rich in thermic rays. Thus we are prepared to look upon the *electric-light cabinet* as a valuable addition to our therapeutic armamentarium, combining as it does, the power of the various rays in the destruction of disease-germs, in the re-establishment and stimulation of physiological metabolism and in the performance of the many important functions of light in and on the animal economy.

As a producer of copious diaphoresis¹ the electric-light

¹In the second part of this book frequent reference is made to the electric-light bath. This invariably refers to the incandescent-light bath unless the arc-light bath is spoken of as such.

cabinet rivals the dry-heat cylinder. Winternitz states that since the introduction of the light-cabinet he has practically abandoned the hot-air cylinder. The light-bath produces sweating without the intense heat of the hot-air apparatus.



INCANDESCENT LIGHT BATH.

The light-bath is, therefore, indicated in all cases to which the dry-heat apparatus is adapted. Whenever cutaneous excretion is to be stimulated, the dry-heat cylinder, and, therefore, the electric-light cabinet will do the work. Either will alter, stimulate and rectify metabolism promptly. Either

... ..
... ..
... ..
... ..

Electronen-Gesellschaft
SANITAS
Berlin, N.



INCANDESCENT AND ARC LIGHT BATH CABINET.

reports of one of the numerous German photo-therapeutic institutions, and shows the clinical importance of the light-bath more eloquently than any physiological and therapeutic argument could possibly demonstrate it. The cases were all treated in the electric-light bath.

NAME OF DISEASE	No. of Cases	Cured	Much Im- proved	No Result
Rheumatism	116	81	30	5
Gout	86	53	33	...
" Deformative	3
Neurasthenia and Hysteria (nervous disorders)	82	45	31	6
Lues	64	46	16	2
Obesity	62	50	10	12
Asthma	49	40	9	3
Gonorrhea and consequent disorders	38	20	15	3
Heart disease	36	...	36	...
Fatty Degeneration of the Heart	33	20	13	...
Sciatica	32	28	...	1
Bronchial Catarrh and Emphysema	28	10	18	...
Neuralgia	24	6	17	1
Ulcus Cruris Varicosum	23	10	7	6
Stomach and Intestinal Catarrh	20	5	15	...
Mild Affections of the Liver	20	10	7	3
Affections of the Knee-Joint	15	10	5	...
Nephritis	15	...	15	...
Lumbago	14	14
Catarrh of the Ear and Deafness	14	1	9	4
Nasal Catarrh, and Affection of the Larynx	13	5	8	...
Anemia	12	...	12	...
Diabetes	10	...	10	...
Headache	5	5
Chronic Constipation	4	1	3	...
Professional Illnesses	3	2	1	...
Erysipelas	3	3
Influenza	3	3
Contracted Scars	2	2
Ulcus Molle	1	1
Skin Diseases (Herpes, etc.)	63	24	33	6
Tabes	40	...	7	33

The following table shows the results of light-treatment in another one of the German institutions :

NAME OF DISEASE	No. of Cases	Cured	Much Im- proved	No Result
Neurasthenia	23	4	9	10
Myalgia	14	14
Psoriasis Luetica	1	1
Psoriasis	3	1	1	1
Lues	3	1
Chronic Rheumatic Arthritis	20	7	10	3
Chronic Muscular Rheumatism	14	15	10	9
Gout	20	9	9	2
Neuralgia	9	5	2	2
Abscess	4	1	2	1
Influenza	1	1
Furuncle	2	2
Eczema	1	...	1	...
Prurigo	1	1
Plethora	2	1	1	...
Meningitis Spinalis	1
Lupus	1	1

It is always to be emphasized the importance of the light-therapy treatment of wounds, injuries, and also as an adjunct to the recovery of operative surgery. Wounds under a moderate degree of tension promptly and without much local anesthesia, by enclosing in electric-light cabinet the light-rays which are produced should not be lost sight of. It is to be remembered that the chemical rays abound. In all cases of wounds, however, the heat-rays predominate. It is to be remembered also important to remember that discharges of various kinds, as chest treated in a cabinet corresponding to the size of the area to be treated. Electric-light cabinets are made in a wide variety of shapes and sizes.



FIG. 1. ELECTRIC-LIGHT CABINETS FOR USE ON THE BODY.

The treatment of the various diseases would not be complete without a consideration of the effects of electric-light rays (light-rays) as they enter into physiotherapy. The electric-light rays, as they enter into physiotherapy which have been used in the treatment of various diseases and others from the treatment of the various diseases, there can be no doubt that the light-rays, even when from the reflection of the sun, are of great value as affected by different conditions of the various waves of light as the nerve-stimulation. — — — — — It was upon the sympathetic nervous system and through the operation of the vegetable and more especially the spinal functions of the economy. The

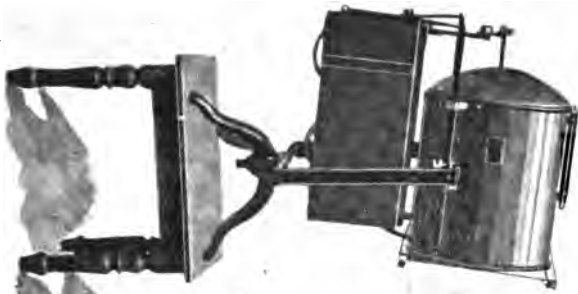

ELECTRICITÄTSGESELLSCHAFT
Sanitas
BERLIN, N.W.



A MODERN COMBINED ELECTRIC LIGHT BATH.

It behooves me to emphasize the importance of the light-bath in the treatment of wounds, injuries, and also as an adjunct in the practice of operative surgery. Wounds under the influence of light heal promptly and without much local disturbance. In selecting an electric-light cabinet the physiological effect to be produced should not be lost sight of. In the arc-light cabinet the chemical rays abound. In the incandescent-light cabinet the heat-rays predominate. In addition to this it is important to remember that distinctly local conditions are best treated in a cabinet corresponding in size to the part to be treated. Electric-light cabinets and cylinders are made in all shapes and sizes.

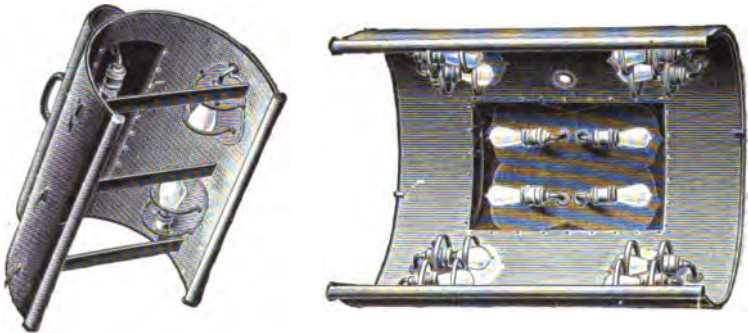

ELECTRIC LIGHT BATH FOR SPECIAL PARTS OF THE BODY.

The discussion of this interesting subject would not be complete without at least a cursory mention of the effects of different colors of light in the cabinet (chromo-therapy). Abstracting from the many illusory statements which have been made on this subject by physicists, poets and others from the time of Goethe up to the present, there can be no doubt that the human organism, even aside from the responsive function of the visual apparatus, is affected by different colors in characteristic ways. *Red* is the nerve-stimulant *par excellence*. It acts upon the sympathetic nervous system and through this upon all the vegetable and more especially the animal functions of the economy. The

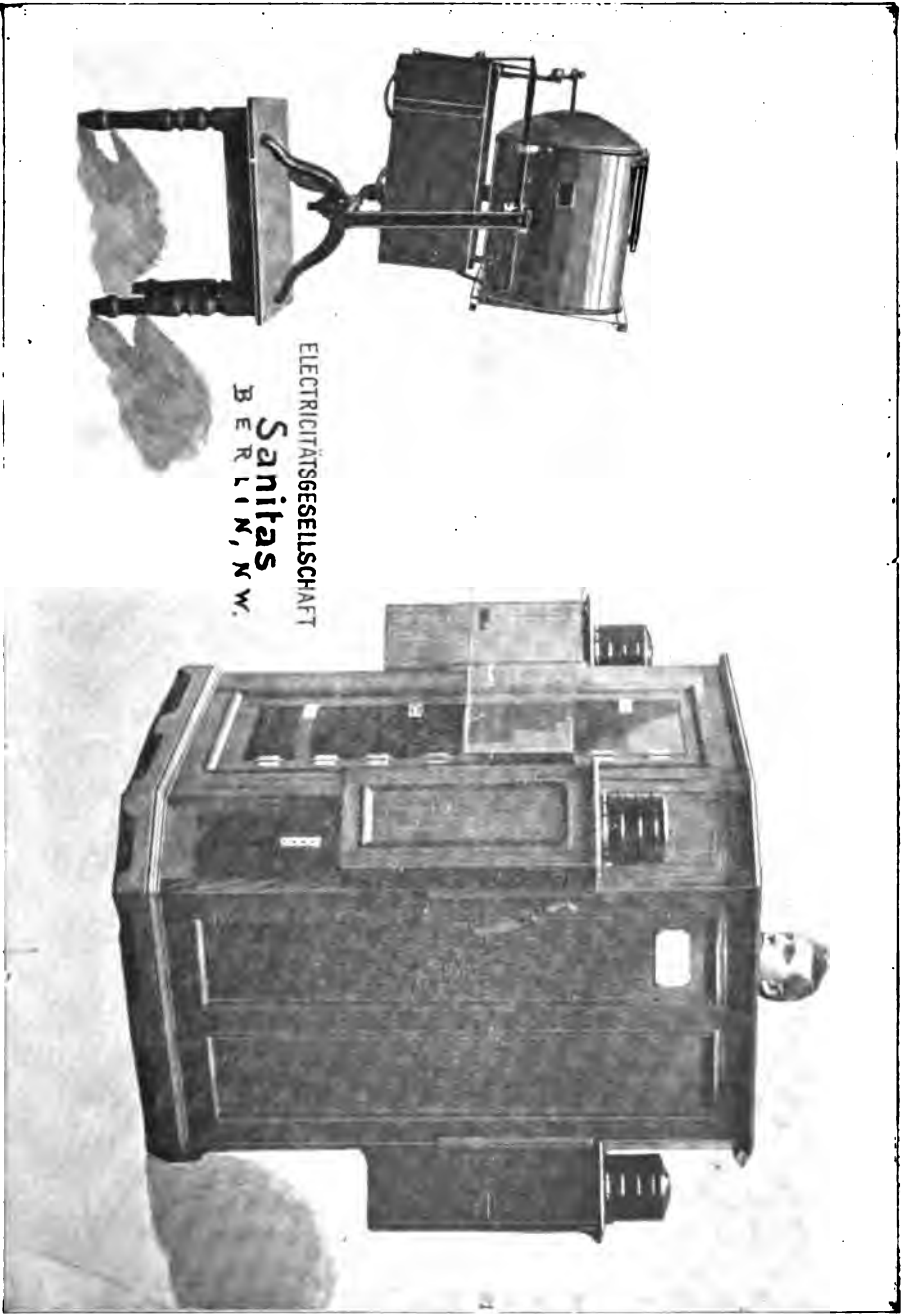

A MODERN COMBINED ELECTRIC LIGHT BATH.

sexual organs are easily affected by red color-effects. The red lights, gowns and furnishings of the shrines of Venus Vulgivaga are not without their purpose. Red has ever been known as the color of passion and love. *Green* is a mild sedative. It quiets the mind and eases the body. A sense of buoyant tranquillity and hopeful expectancy comes over the organism. *Blue* is still more distinctly sedative. It



BIDET FOR APPLICATION OF LIGHT TO THE EXTERNAL
FEMALE GENITALIA.

is said to rectify metabolism, to cleanse the organism and to rejuvenate the weak and ill. *White* combines the effects of all the colors.

So much for light and its therapy. "Let there be light!" The Creator wisely indicated a great photo-therapeutic truth in these words. First he wanted light, then he created life. We must have light before we can have life and health. Let us have light, for—by the Shades of Hippocrates!—we can not get too much light in medicine.

CHAPTER VIII.

THE ELEMENTS OF ELECTRO-PHYSICS AND ELECTRO-MECHANICS.

MUCH valuable space, time and energy have been spent by authors and practitioners in the discussion and study of electricity. Electro-therapy and electricity are two altogether different things. In order to practice electro-therapy successfully and scientifically, it is not necessary to be an expert electrician or electro-physicist. A man may be a skillful pianist and good musician without knowing much about the art and science of piano-building or the physics of sound. The drug-dispensing physician need not be a pharmacist or a pharmacologist. The essentials in the make-up of a good electro-therapist are a general knowledge of physiological medicine, of electro-physiology and enough mechanical knowledge of his machines and their purposes to enable him to operate them and make incidental repairs. As a matter of fact, a good electro-physicist does not necessarily make a good electro-therapist. He is prone to become an electrical fanatic and is likely to be accused of riding a hobby. In this way he is certainly not benefiting either the cause of electro-therapeutics or of general medicine whose servant, not mistress, electricity in the hands of the physician should be.

I shall attempt to present the rudiments of electro-physics and electro-mechanics as briefly and simply as is consistent with intelligent discussion of the subject. The magnetic properties of amber (*electron*) were noticed by the ancients, who named the mysterious force in amber *electricity*. The word *magnetism* is probably derived from the

name of an ancient country, Magnesia, where (magnetic) iron ores abounded. Both electricity and magnetism were thought to be, up to within a comparatively recent time, imponderable fluids that were too fine for our senses to perceive. These fluids were supposed to flow through a wire or any other conductor as water flows through a pipe. Our own Benjamin Franklin held this view.

Electricity is neither a fluid nor is it a distinct force which can be separated from matter. It is a force-modality which becomes manifest by a peculiar state of matter and consists in peculiar vibrations of the molecules of the interposed ether. The knowledge of the peculiar states of matter or the favorable physical conditions which give rise to manifestations of this special force-modality is the science of *electro-physics*. We look upon electricity as being potentially omnipresent. Our knowledge of electro-physics enables us to produce the physical conditions which will change the *potential* force into an *actual* force-modality. Thus we distinguish between potential electricity or *electricity at rest*, and actual electricity or *electricity in motion*. To set anything in motion there must be sufficient pressure at some point. Water would remain stationary in a pipe unless pressure is present to cause it to move, even if this pressure is only the force of gravitation. Analogously, there must be some motive power to cause electricity to "flow." This power, which is the *vis a tergo* of electrical motion, is known as the electro-motive force, also the *voltage*, the tension, the pressure of an electrical current. A unit of electro-motive force is known as a *volt*.

Water running out of a faucet may be measured quantitatively without regard to the speed or force with which it is running, by allowing the water to run into a bucket, capable of holding a definite quantity, say a gallon. When the bucket is full, we call the quantity of water contained in the bucket, a gallon of water. It may run out in two minutes or in an hour. It is a measurement of quantity pure and simple. If we measure an electric current in an analo-

gous way without regard to electro-motive force or time consumed, we are measuring the amount of current pure and simple. A unit of quantity pure and simple is known as a *coulomb*.

If, in measuring the quantity of current, we wish to convey a definite statement concerning the rate at which a unit of quantity is "flowing," we express such quantity plus rate of flow in the *amperage* of the current. A unit of amperage is called an *ampere*. It represents one coulomb passing a given point during one second of time. The one-thousandth of an ampere is called a *milliampere* and is the unit of measurement which is used in electro-therapeutics. The currents commonly used in medicine have very low amperage.

A substance carrying or capable of carrying electric currents or charges is called a *conductor*. Not all substances allow an electric current to pass through them with the same degree of facility. Some of them make good conductors, like copper and most metals; others are not so good (water, graphite, dry wood, etc.), while some substances do not transmit or carry electricity at all (glass, silk, rubber, etc.). The latter are known as *insulators*. The less *resistance* a substance offers to the passage of a current, the better conductor this substance would be. We gauge the conducting quality of a substance by the degree of resistance it offers. The resistance offered to the passage of a current is an item of some importance. A unit of resistance is called an *ohm* (named after Dr. G. S. Ohm, one of the early investigators of electricity). If a certain conductor offers a certain amount of resistance, it stands to reason that the force of the current must be sufficiently increased in order to overcome the resistance. If a certain amount of current is to pass a given point in a certain time, we must have a certain amount of electro-motive force. To cause one ampere (*i. e.* a certain quantity in a second of time) of current to overcome one ohm of resistance, it is necessary to have an electro-motive force of one volt. If

the electro-motive force remains one volt, the amperage of a current must become less if the resistance increases and *vice versa*. The three factors, *voltage*, *amperage* and *resistance*, are so intimately related to one another that a variation in one necessarily affects the other two. The necessary relation between these three factors was expressed by Dr. Ohm in his famous law (*Ohm's law*) which states that *the amperage is always in direct proportion to the voltage and in indirect proportion to the resistance*. By knowing the exact amount of any two of the three factors, we can figure out the amount of the remaining one. Ohm's law is expressed in the forms of an equation thus:

$$\text{Amperage} = \frac{\text{voltage}}{\text{resistance}}$$

Transposing the factors, the equation would read:

$$\text{Resistance} = \frac{\text{voltage}}{\text{amperage}} \quad \text{or}$$

$$\text{Voltage} = \text{amperage} \times \text{resistance}.$$

An ohm is approximately equal to the resistance of a copper wire 250 feet in length and 1-20 inch in thickness. An instrument which will change a current of a certain amperage and voltage into a current of different amperage and voltage is known as a *transformer*.

It would be a needless expense of energy to go into the technical details of the general subjects so far touched upon. It is not our aim to become electricians or electro-physicists but to get a clear conception of the theoretical part of the subject as far as the practice of electro-therapy requires it. There are some additional minor subjects that it is necessary to discuss. I shall present them in a brief and practical manner under special heads.

HOW VOLTAGE IS PRODUCED.—Electro-motive force is principally generated by either *chemical* action (cells of various kinds) or by *mechanical* energy (dynamoes, static machines).

Chemical Action.—If a piece of zinc and a piece of copper are partly immersed in a weak solution of sulphuric acid, a current of electricity will flow from the copper to the zinc. The electrical energy is the direct product of the chemical action set up. The pieces of zinc and copper are known as the *elements*, while the medium in which they are immersed and in which the chemical action takes place is known as the *electrolyte*. The jar, receiver or container, including the elements and the electrolyte, is known as a *cell*. A number of cells properly joined together is called a *battery*. The parts of the elements which are outside of the electrolyte, are called the *terminals*. The exposed part of an element is opposite in polarity to the immersed portion, *i. e.* if the immersed portion is positive, the exposed part of the same element is negative. When we speak of the positive or negative pole of a cell, we always refer to the exposed parts of the elements or to the terminals proper. If zinc is the negative element of a cell, it is the exposed part or the terminal of the zinc that is referred to as being negative. The negative terminal always belongs to the element which is acted upon by the electrolyte. If the electrolyte is a liquid, the cell is known as a *wet* cell; if it is held in the pores of some porous solid, the cell is called a *dry* cell. When, owing to the collection of hydrogen on one of the elements, the electrolyte is no longer active, the cell is said to be *polarized*. Any agent by which polarization is removed is known as a *depolarizer*. The decomposition of liquids by means of electricity is called *electrolysis*. The atoms set free are called *ions*. The element from which the electric energy emanates toward the liquid is called the *positive* element or *anode*, the liberated atoms traveling in this direction being known as *anions*. The element which draws the energy away from the decomposing fluid is known as the *negative* terminal or *cathode*, the atoms traveling in the direction indicated being known as *cations*. There are many different varieties of both wet and dry cells. An apparatus in which electric energy is accumulated which

can be liberated in the form of an electric current is known as an accumulator, a secondary battery or a storage-battery. Electricity generated by wet, dry and storage-cells is said to be produced by *chemical action*.

Mechanical Energy.—If a piece of metal has the constant property of attracting or repelling other bodies it is called a natural *magnet*, the property of attraction and repulsion being known as *magnetism*. If this property is temporarily produced in a piece of metal by the passage of an electric current near or around the metal we speak of an *electro-magnet* and *electro-magnetism*. The magnet is surrounded by a field of magnetic force known as the *magnetic field*. By placing a conductor in the field of force surrounding a magnet, a current of electricity can be generated. By placing a piece of suitable metal inside of a coil of wire carrying a current of electricity, the metal will become magnetic and remain so, as long as the current "flows." The current magnetizes the metal (metallic core). When the current stops, the metal becomes *demagnetized*. To produce magnetism by an electric current and to generate electricity by magnetism is made possible by the close mutual relationship existing between the two force-modalities. It is another illustration of the physical phenomenon which consists in the changing of one force-modality into another force-modality (*Kraftumwerthung*). The two instances quoted are of the utmost practical value and importance because they contain the principles which underlie the modern dynamo, and, in a somewhat varied sense, the so-called electro-static induction-machine. The electricity generated by these different apparatus is said to be produced by *mechanical energy*.

DIFFERENT KINDS OF ELECTRIC CIRCUITS.—An electric *circuit* is the path of the electric current from one terminal of the generating source through various conductors back to the other terminal of the generating source. As long as the electric current flows, the circuit is said to be closed; if a break occurs, the electric circuit is said to be open and

the current ceases to flow. If the ground or earth is a part of an electric circuit, the latter is spoken of as a *grounded circuit* (frequently employed in static electricity). Sometimes a circuit is split up into branches or smaller circuits. A branch of a divided circuit of this kind, carrying electric energy and being really a part of the circuit, is called a *shunt*. If the cells composing a battery, are joined, the positive element of one cell connecting with the negative element of the next cell, the cells are said to be arranged *in series*. If, on the other hand, the positive elements of the cells are joined together by wires which form one common conductor and the negative cells are likewise joined and form one common conductor, the cells are said to be arranged *in multiple* or *in parallel*. The terms "in series" or "in multiple" ("in parallel") are used in an analogous way in regard to any kind of electrical attachment or apparatus. Whenever motors, incandescent lamps, etc., are put in a circuit, they are wired "in series" or "in multiple," the meaning of the two terms being the same as suggested in regard to the wiring of cells. A *short circuit* is a circuit which is complete before it reaches the conductors. If, while a patient is receiving a static treatment, *e. g.* a crown breeze, we were to bring the terminals of the machine (horizontal sliding rods) together, the patient would not get any more electricity because the machine is short-circuited, *i. e.* the circuit is complete before the current reaches the conductors which carry the current to the patient.

DIRECT AND ALTERNATING CURRENTS.—Whenever there is constant pressure (electro-motive force) in one direction, the current is known as a *direct* current. If the pressure (electro-motive force) changes from one direction to the other, the current is called an *alternating* current. The pressure begins at the zero-mark (no potential difference) and rises until it has reached the maximum and drops down to zero and beyond it, *i. e.* it exerts pressure in the opposite direction until it has reached its full degree of tension. It again returns to the neutral point and the same process as

before is gone through. The voltage of such a current might be represented by a curve or rather a double curve, one above and the next one following it below a neutral level. Each curve is called an *alternation*. Two successive alternations constitute a *cycle*. The time consumed in the completion of a cycle is called a *period*. The number of alternations which occur in one second is called the *frequency* of the current. Thus, a *high-frequency* current is one which is characterized by the high number of cycles which are completed in one second. The number may reach into the thousands and millions.

INDUCTION.—If a body holding an electrical charge or a conductor carrying an electric current causes electrical phenomena (attraction, repulsion, current) to appear in neighboring bodies which are in no way connected with the electrified body or conductor, such phenomena are said to be produced by *induction*. Induction, therefore, is an influence by which electrical phenomena are produced without contact. The large balls in front of a static machine will attract bits of paper and other small bodies or repel them, showing that there must be a sphere or a field of electrical influence around these accumulators of static electricity. If a wire is brought near another wire, the latter carrying an electrical current, at once there will be an electrical current set up in the wire which is brought near it. This shows that the wire carrying a current is surrounded by a field of influence which charges bodies or wires without there being any contact with the wire which carries the current. The influence which produces these phenomena, is called induction. Charges or currents produced by induction are known as induced or secondary charges, induced or secondary currents. The sphere of magnetic influence around a magnet is known as the *magnetic field*. If a magnetizable substance is brought within this magnetic field, it will become magnetic. The influence producing this phenomenon is called *magnetic induction*. Faraday took a core of iron, insulated it perfectly and wound a coil of wire over the insulated core. He

then covered the coil of wire with an insulating substance and wound another wire over this insulation. By allowing a current to pass through the wire covering the core, the core became magnetic and another current was set up in the outside wire. The current in the outside wire is known as the *induced* or secondary current. This is the principle of the faradic coil. Another pertinent example of induction is the appearance of a current in the outer armature of a Leyden jar, there being no contact between the outer and inner coating of the jar. The current in the outer coating is an induced or secondary current.

POLARITY.—Electricity, although it is universally present, becomes an actual force-modality as soon as—by chemical action or by mechanical energy—the state of latency or neutrality is disturbed. The action which sets a current in motion in a cell, takes place between two suitable elements immersed in a suitable medium. It disturbs the potential or the level of the energy and, as a result, a current flows from the higher level to the lower one. The higher level is called the *positive* element or positive pole (anode), the lower level is known as the *negative* element or negative pole (cathode).

COMMON ELECTRICAL TERMS.—*Binding posts* are clamps, thumb-screws or any kind of device by which conducting wires are attached to an electrical apparatus. A *pole-changer* (polarity-switch, current-reverser, rheotrope) is a device for changing the direction of a current without disturbing the conductors. *Electrodes* are the instruments which are attached to an electrical apparatus by means of cords or wires and by which electricity is applied to the human body. Electrodes may be sponge-handles, metallic handles, brushes, rollers, large or small metallic balls, large or small crowns, needles, etc., etc., etc. A *rheostat* is an instrument by which a definite amount of resistance is brought into the path of an electric current. Practically, therefore, it is an instrument by which the strength of a current can be increased or diminished. A *rheotome* is an

instrument by which an electrical circuit is completely broken. An *ammeter* is an instrument by which the amperage of a current is measured. If the current is of very low amperage (*e. g.* less than one ampere) an instrument, called *milliamperemeter* is used, which measures the strength of the current in milliamperes. A *switch* is a device consisting of metallic bars movable on a pivot, used for the purpose of connecting or disconnecting conductors or of changing the path of an electrical current by turning it into a different conductor.

ELECTRO-THERAPEUTIC CURRENTS.—There are four kinds of electric currents used in medicine to-day, to wit: (1) the *constant* (galvanic, continuous) current which is generated by wet or dry cells or by some form of mechanical energy (central lighting and power station)—it is a current of a given maximum amperage and traveling in one direction with certain pressure; (2) the *interrupted* (faradic) current, which is obtained by passing a constant current through an insulated coarse wire wound around an insulated piece of iron or a core made up of a bundle of pieces of iron-wire of equal length. The moment a current passes through the coil of wire wound around the iron-core, the latter becomes magnetic and the lines of magnetic force which surround it permeate the convolutions of wire around the magnetic core. The result is a rise in the electro-motive force. The little hammer which is mounted on a flat metallic spring and is stationed at one end of the core, is attracted towards the core the moment the latter becomes magnetic. The back of the flat metallic spring is in contact, or nearly so, with a platinum-point between which and the spring the electric spark passes. When the hammer is in contact with the core, the circuit of electricity is broken, because the metallic spring is drawn away from the platinum-point and no spark passes as a result. This is followed by demagnetization of the core. The hammer is no longer held by the core, but returns to its original position, thereby re-establishing current in the coil of wire and magnetism in the

core. The magnetism in the core again causes the hammer to be attracted and thus the current to be broken. It is a constant make and break of current and a coincident magnetization and demagnetization of the core. The moment magnetization occurs, electro-motive force is generated in the wire surrounding the core. At the moment of demagnetization the direction of electro-motive force of the current is reversed. The coarse wire which is wound around the core is known as the *primary wire*, and the current which it carries, as the *primary current*. The coil of fine wire wound around the insulated primary coil is known as the *secondary wire*. This wire is in the magnetic field of the core and of the primary wire. The moment a current is generated in the primary wire, there is an induced or *secondary current* in the secondary wire. According to an established electrical law the induced current travels in a direction opposite to that of the primary current. There are the same alternations of electro-motive force, only in the reversed order. Every twist of wire situated in a magnetic field cuts the lines of magnetic force and increases the voltage. Owing to the greater number of convolutions of fine wire in the secondary coil as compared to the number of twists of coarse wire in the primary wire, the electro-motive force produced by breaking the lines of magnetism is necessarily much higher in the secondary current than in the primary. The hammer-attachment is what gives to this current its interrupted character. The presence of the magnetized core accounts for the increase in voltage. Thus the faradic current is a galvanic current modified by the laws of magnetism and induction. To interrupt a galvanic current by a switch or by means of rheotome does not make a faradic current out of it. A faradic current is properly known as an *interrupted current*. A galvanic current frequently broken by means of a rheotome is known as an *interrupted galvanic current*. (3) The *static* current, generated by friction and variously known as Franklinic or frictional electricity, has recently risen to a high plane of therapeutic

usefulness. It is produced by the static machine, of which there are several types, which differ in their physical principles and mechanical construction. The static machine will be discussed under a separate heading. The static current is one of intense electro-motive force, the number of volts rising into the thousands, while the amperage is very low. (4) The *high-frequency* current is an alternating current characterized by a very high-frequency of alternations (500,000 and more per second). High-frequency currents may be applied in various ways. The therapeutic importance of the subject justifies its separate discussion under a special head. The so-called *sinusoidal* current, which is an alternating current and is hardly ever used by electro-theraputists nowadays, is generated by an armature or coil which is rapidly revolved within the magnetic field of another coil and core.

The electro-mechanical education of an electro-therapeutist consists largely in the knowledge of the apparatus and machines which are used for the purpose of generating the constant, interrupted, static and hyper-static (high-frequency) currents and in the possession of skill taking care of and operating these machines. Modern electro-therapy has eliminated many of the cumbersome mechanical devices which were *en vogue* years ago. The *constant* and *interrupted* currents are usually furnished by a combined switch-board (wall-plate, table-plate, galvano-faradic cabinet), which is connected with the street-circuit or supplied with cells. The switch-boards (galvano-faradic wall-plates) are to all intents and purposes variations of the same original type. Some may be richer in finish and more pretentious in technical construction. The addition of attachments for diagnostic lamps and cautery has enhanced their usefulness very materially. From a strictly electro-therapeutic point of view their value consists in their aptitude to furnish galvanic and faradic currents and to enable the operator to modify the administration of these currents in keeping with his clinical purpose.

THE GALVANIC-FARADIC SWITCHBOARD.

The switchboard, which is in general use for the purpose of controlling the constant (galvanic) and the interrupted (faradic) current, has the form of a wall-plate, roller-cab-



A FARADIC-GALVANIC ROLLER CABINET.

inet or table-plate. The electricity which is supplied to this switchboard is generated and furnished either by primary (wet or dry) batteries, secondary (storage) batteries or by the central lighting supply (street-current).



DIFFERENT TYPES OF SPONGE ELECTRODES.

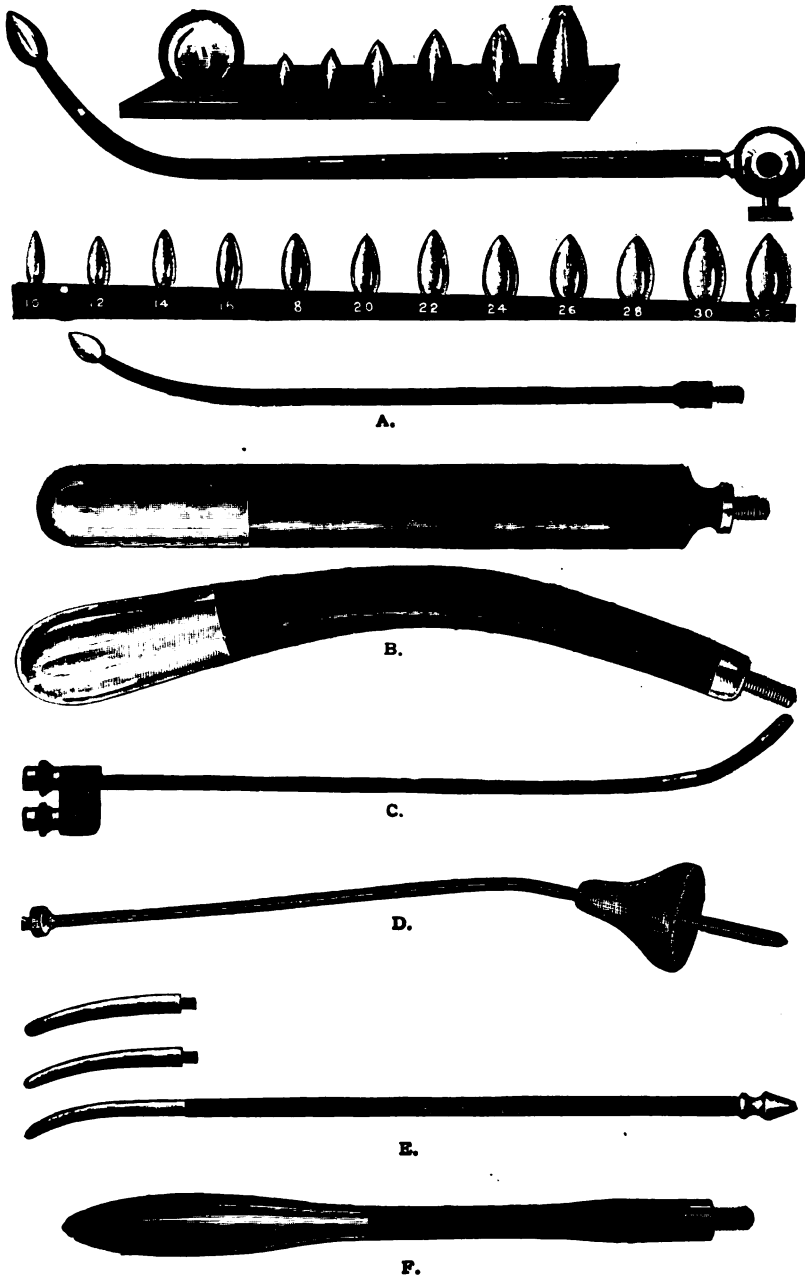

A. Two sets of tips and handles. B. Straight and curved vaginal electrode. C. Bipolar uterine electrode. D. Uterine cup and stem electrode. E. Uterine copper electrodes. F. Rectal electrode.

For the control and regulation of the current, which must be of sufficient quantity and of proper electro-motive force, the switchboard is supplied with a rheostat and with selector-switches. If the current is supplied by the street-circuit, a controller in the form of one or more incandescent lamps regulates the amount of current received.

In order to adapt the amount of the available current to the requirements of therapeutic work, the strength of the current is modified by means of a *rheostat*. The rheostat is an instrument which enables the operator to introduce any desirable amount of resistance and to lessen the current-strength accordingly. The best rheostat is made of coils of German-silver wire. A fairly good and much cheaper instrument is the graphite rheostat. The graphite rheostat has a handle, the movement of which influences the amount of current.

The so-called *selector-switches* enable the operator to select, by proper use of a special switch, the kind of current he desires, *e. g.* a constant (galvanic) current or a primary or a secondary interrupted (faradic) current, as the case may be.

It is impossible to do exact therapeutic work with the constant (galvanic) current without being able to measure the amperage of the current used. An instrument which is used for this purpose is called an *ammeter*. Since, however, the amperage of a therapeutic constant current hardly ever exceeds one-half of an ampere (500 milliamperes), an instrument for measuring minute quantities of current is used. An instrument of this kind is called a *milliamperemeter*. One of the types of milliamperemeter ordinarily used consists of a needle which turns freely on a pivot and is connected with a magnet which is influenced by the earth's magnetism. A coil of wire which is parallel to the magnet is traversed by an electric current, the result being deflection of the needle away from the earth's magnetic meridian. Another type, known as D'Arsonval's milliamperemeter, consists of a powerful permanent magnet, between the poles of



A.



B.



C.

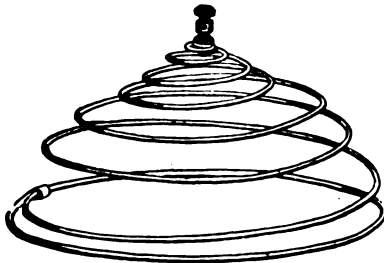

D.

A. Roller electrode, hard rubber, set with metallic points, for muscular faradization, with current interrupter. B. Bennett's multiple needle-holder. C. Brush electrode. D. Bennett's abdominal electrode.

which a core of soft iron, surrounded by a coil of wire, is suspended. An indicating needle is attached to this coil. When a current passes through the coil, the latter will tend to take a position at right angles to the poles of the permanent magnet. This causes the needle to move over an indicating scale. The scale may be single or double. By being able to regulate the circuit in the milliamperemeter (usually by means of a plug-attachment), a fine and a coarse scale can be used to great advantage.

Sometimes it is desirable to interrupt the galvanic current and administer it in the form of shocks of suitable severity and rapidity. The relative rapidity of these shocks is determined by an instrument called a *rheotome*, of which there are several types. Probably the best known is the clock-work rheotome.

The *polarity* of the switchboard depends on the polarity of the current supplying it. The two wires carrying the current from the street or from the cells are respectively positive and negative. In installing the switchboard it is of vital significance to wire it with proper regard to the polarity of the supply-wires. Each switchboard is supplied with a polarity-switch (pole-changer). Connect the switchboard with the supply-wires and attach the conducting cords (*i. e.* the cords which are used in giving treatment). Place the metal-tips of these cords in a glass of salt-water after the current has been turned on. The negative current will decompose the water and cause bubbles of gas to accumulate on the metal tip of the negative wire. Notice the position of the polarity-switch (pole-changer) and see whether the handle of the switch is on the left or the right side. You have already found out which one of the conducting cords is carrying the negative current. Notice whether the cord is on the left or right side. This will tell you which side of the polarity-switch is negative (*i. e.* the side of the negative cord). The opposite side is necessarily positive. By bringing the handle of the polarity-switch over to the other side, you will reverse the order of things, making the heretofore

positive side negative and the heretofore negative side positive. This is why the polarity-switch is frequently called the *pole-changer*. Sometimes the pole-changer is marked "positive." This is to say that the side of the pole-changer-handle is to be the positive side of the switchboard. In order to have it so, the supply-wires (from cells or street) must be

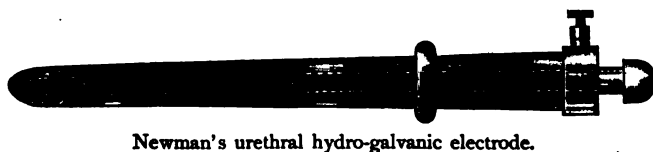
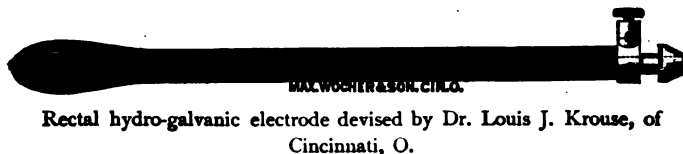
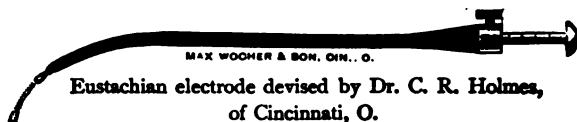

attached accordingly. The salt-water test should invariably be made.

Every switchboard has a *faradic induction-coil* for the production of the interrupted (faradic) current. Its construction has already been referred to. The interruptions may be coarse or fine, depending on the character of the interrupting device ("vibrator"). There are several of the latter *en vogue*. Some coils are supplied with a different kind of a vibrator at each end of the core. The different currents coming from the faradic coil may be decreased or

increased. They may be coarsely interrupted by a rheotome. Faradic current is not measured by a milliamperemeter.

In addition to the parts mentioned a switchboard may be equipped with additional controllers, voltmeter, attachments for diagnostic lamps and cautery.

The *conducting cords* are made of fine copper wire or brass tinsel, cotton or silk covered. They should be strong, durable and pliable. They terminate in metal tips, which are attached to the binding-posts on the switchboard, the free ends being connected to the *electrodes*, of which there is an unending variety. The work which an operator proposes to do, determines the kind of electrodes he is to use, *e. g.* sponge-electrodes, metal handles, electrolytic needles, uterine, urethral, rectal, nasal, laryngeal electrodes, etc.

The Static Machine.

The common type of static machine in use in this country is constructed after the models originated by the two physicists Toepler and Holtz, and contains the physical principles of their machines. For any detailed discussion and description of the subject see any good text-book on physics.

The generation of static electricity in the ordinary Toepler-Holtz machine takes place by *friction* (tinsel-brushes against brass knobs), *conduction* along the metal framework and *induction* on the glass-plates.

The plates (glass, mica, rubber) are stationary and revolving. The revolving plates move in a direction opposite to the movement of the hands of a watch, *i. e.* from right to left. The size of the plates determines the voltage, the number of the plates the amperage of the current. The discharge of the electric current takes place in front of the machine between two small balls which represent the *terminals* of two horizontal sliding rods. The distance between these balls determines the length of the spark.

A static machine should be kept free from *dust* and *moisture*. A dry clean machine ought to work in all kinds of weather and in any climate. The outside of the case

should receive a dry cleaning (soft rag) every morning. The metal parts should be polished. Alcohol should be used sparingly. It has a tendency to take the lacquer off the metal. A dry polish-powder is preferable. Every two or three weeks the case should be washed with soap and water,



A MODERN TOEPLER-HOLTZ MACHINE.

and afterwards carefully dried. The inside of the case should be ventilated once or twice a week on dry bright days. The case and the plates should be wiped with a soft dry rag (silk). By wrapping the rag around a stick and hold-

ing the latter between the slowly revolving plates, the dust from the latter is easily removed. Sometimes it is necessary to slightly moisten the rag with alcohol before it is possible to remove the layer of dirt from the plates. If, after thoroughly cleaning the machine, the latter refuses to work, the trouble is due to moisture and the operator must resort to some artificial way of drying the inside of the case. H. C. Bennett gives the following directions for the use of ice and salt: "Take a one-quart glass fruit-jar with screw top, fill with a mixture of powdered ice and rock-salt, screw down the cover and wipe the moisture from the outside of the jar; place the jar in a saucer or bowl inside the case of static machine, close the door and set the machine in motion, keeping the plates moving until the machine begins to generate at its best. After, say an hour, when the ice is fairly melted, remove the jar and quickly close the end door so as to prevent the outside air from getting into the case."

By all odds the simplest, cleanest and most effective way of drying the inside of a static machine is the use of five or ten pounds of fused chloride of lime (dry, hard lumps) in one or more earthen or porcelain dishes. The lime is markedly hygroscopic. The operator ought to watch the conditions of moisture in the case. A little cheap instrument, called a *hygrometer*, hung in the case, is very serviceable. Frequently the machine can be started by simply making a fire in the room.

The static machine can be operated by hand or by different kinds of power (water, electric). The best way of driving a machine is to run it by means of a good one-third horse-power electric motor.

The current which is generated by a static machine is one of high voltage. It has been determined experimentally that it requires approximately 8,000 volts to produce a spark one inch in length. There are three modes of static discharge. If the electric energy travels along a conductor, *e. g.* a brass rod held by the hand of the patient, the current is discharged into the hand of the patient directly as though

the hand were a part of the conductor, which, in reality, it is. This is a *conductive* discharge (*conduction*). Helmholtz assumed that the atoms of atmospheric air surrounding the surface of a highly charged conductor are dislodged and carry off minute charges of electricity. This takes place when the collecting-combs in the static machine discharge

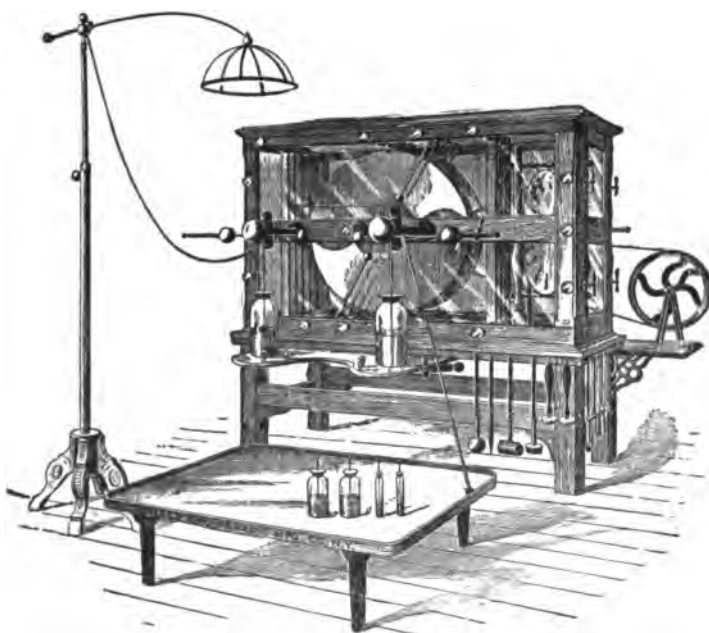

A HOLTZ INFLUENCE MACHINE.

toward the revolving plates. This mode of discharge is called *convective* discharge (*convection*). This is the physics of the so-called static *breeze* or *spray* to be considered hereafter. If the convection takes place in the form of a faintly luminous discharge from a pointed or small rounded positive conductor, it is known as a *brush-discharge*. If the electric discharge occurs suddenly across an

intervening non-conductor it is called a *disruptive* discharge (*disruption*), and assumes the form of a *spark*. The non-conductor interposed between two conductors (*e. g.* the air between the terminals of a static machine or the glass between the inner and the outer coating of a Leyden jar) is called the *dielectric*.

The mode of discharge is in no inconsiderable manner influenced by the surface whence it is given off. Even and uniform surfaces accumulate static electricity and for this reason favor disruptive discharges (sparks). In order to administer static sparks to a patient, the operator would use an electrode with an even and smooth surface (*e. g.* a ball-electrode). Small balls and points favor the formation of brushes or sprays (breezes), especially if the end of the electrode represents an aggregation of numerous points, *e. g.* the crown-electrode, which is used to administer a head-breeze.

THE GROUND-WIRE.—An iron pipe (water, gas) connecting with the earth can be used for a ground-connection. The side of the machine to be grounded is connected with the pipe by means of a chain or wire whenever the operator desires to make a ground-connection. Some physicians hook a chain to the metal portion of the machine on the side to be grounded and drop the end of the chain or wire on the floor. This is not sufficient. The connection must be made with the earth deep enough to be in contact with moist ground. The object of grounding is to increase the potential of the current. In some applications of static electricity it is essential for correct technique to ground one side of the machine, *e. g.* in giving the so-called wave-current.

THE POLARITY OF THE STATIC CURRENT.—To be able to tell which is the positive and which is the negative side of the machine is of the utmost importance, because the whole therapeutic part of static electricity depends upon it. The polarity of the machine must be tested before a treatment is given. No two machines are alike. Some machines change polarity frequently. There are several ways of tell-

ing which is the positive and which the negative side of the machine :

1. Start the machine slowly, leaving a spark-gap of one inch. The first spark will be seen to travel from the positive to the negative pole.

2. The positive end of a one-inch spark has a white, the negative a violet color.

3. A five-inch spark has a purple positive end and is bright at or near the negative pole.

4. The "fox-tail" discharge is on the positive side. The negative end of the spark is compact.

5. If a piece of wood is brought near the positive end of the spark, the spark will jump over to the wood. The negative side, if approached, is not disturbed in the least.

6. Ground one side of the machine. Start the machine with the sliding rods five inches apart. If there is no spark, the grounded side is positive. If the spark is more vigorous and thick than usual, the grounded side is negative.

7. Look at the discharging combs between the plates while the machine is running. The negative side will show streams of purple light, the positive side bright points on the ends of the comb-teeth.

8. If a burning candle is held between the terminals of the machine, the flame will point toward the positive side.

9. The positive side attracts dust very readily.

The most valuable point is probably No. 7, because it enables the operator to see the polarity while the patient is being treated.

THE POLE-CHANGER.—Many static machines are provided with a device for changing the polarity of the machine. All of these apparatus (*e. g.* Cedergreen's excellent device) simply reverse the currents in the wires carrying the electric energy from the machine to the patient or to the X-ray tube. They do not in reality change the polarity of the machine. The device simply causes the positive current to be discharged through the wire on the opposite side and

vice versa. In X-ray work a pole-changing device is very serviceable.

THE LEYDEN JARS.—To the human eye a static spark seems like a continuous discharge. In reality it is a succession of discharges which follow each other with great rapidity. Each discharge is an oscillation of electrified ethereal molecules. The rapidity with which these oscillations follow each other constitutes what is known as the "frequency" of the current. If the pressure (electro-motive force) of the current is increased, by induction for instance, the frequency of the discharge will necessarily be augmented. This is the purpose of the so-called Leyden jars, one of which is placed on the shelf on either side of the machine. It consists of a glass jar with a metallic coating on the inside and the outside, the coatings (also called armatures) not extending to more than one-third of the height of the jar. To prevent the creeping of the electric charges over the glass in damp weather, the glass is varnished. The knob on top of the jar is connected with the inner metallic coating by means of a metallic chain. The conductor supporting the knob passes through a dry cork or plug of some insulating material. The knob on top connects with the metallic parts (prime conductors) of the machine on the positive or negative side respectively. When the machine is running, the inner coatings (armatures) of the Leyden jars receive a certain charge of electricity. By induction a charge is generated in the outer coating (armature) of the jar. The outer armature is supplied with a binding-post which may be situated on the shelf in front of the machine and is connected with the outer coating of the jar by a wire. If a conductor (cord, wire) is attached to this binding post, it will carry the current which has been induced in the outer armature. It is a current of higher voltage and greater frequency than the primary static current. It is known as the *static induced current*. The frequency of a current of this kind may be as high as, and even higher than 100,000,000 oscillations per second. Each oscillation is a wave of

ethereal motion, separated from the preceding and succeeding oscillation by a distinct interruption. The greater the number of interruptions, the greater the pressure (electromotive force). The coincident, previously discussed, reversal of the direction of pressure, makes each oscillation equivalent to an alternation. The two terms, therefore, are in this sense used synonymously. The static-induced current, then, is a true high-frequency current.

ELECTRODES.—An instrument by means of which electricity is administered to the patient is called an electrode. A set of suitable electrodes comes with each static machine. The most essential electrodes are,—1. The insulating platform; 2. The large crown (breeze, spray); 3. The small crown (breeze, spray); 4. A ball-electrode (sparks); 5. A wooden electrode (brush); 6. A pointed electrode (brush, small sparks). In addition to these electrodes there ought to be an insulated hook to hold chains out of the way during a treatment and prevent unnecessary sparking. The ingenuity of individual operators has suggested different shapes and sizes of static electrodes, *e. g.* a wire cage for spraying the whole body. The massage-roller is used by some. The cathodic electrode is worthless, because static cataphoresis does not exist.

In giving static treatments the operator should not be hampered by his ignorance of static technique, or by his fear of electricity, or by his awkwardness in handling the machine and the patient. The constant use of sparks has justly become obsolete. A static treatment which causes pain is of doubtful therapeutic value. In a general way it may be said that the gentle and agreeable modes of application answer every therapeutic indication of static electricity.

THE MODES OF APPLICATION ordinarily recognized as such by electro-therapeutists are as follows:

Insulation (positive or negative).—Put the platform in its proper position about two feet in front of the machine and connect the sliding rod on the negative side with the

platform by means of a rod or chain. Ground the positive side. This gives your patient, who stands or is seated on the platform, a negative insulation. If the positive side is connected with the platform and the negative side grounded, the patient gets a positive insulation. This mode of static application is called (positive or negative) insulation, electrification or charge.

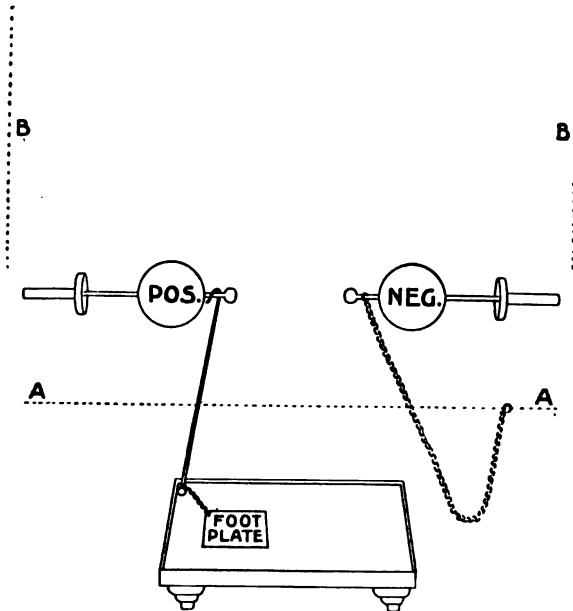

POSITIVE INSULATION.

AA and BB represent ground wires.

Direct or Primary Spray and Breeze (positive or negative).—Connect the sliding rod on the positive side with the platform and the sliding rod on the negative side with the crown (multiple point) electrode, the rods being separated sufficiently to prevent sparks from passing. Hold the electrode at a suitable distance from the patient to allow a stream of bluish fire (shower of fine sparks) to pass. This

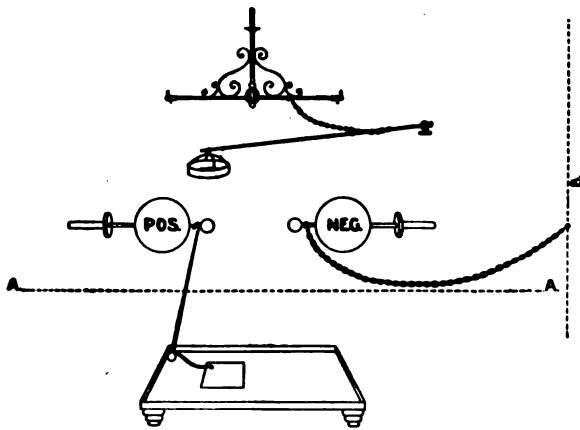

INDIRECT NEGATIVE SPRAY.

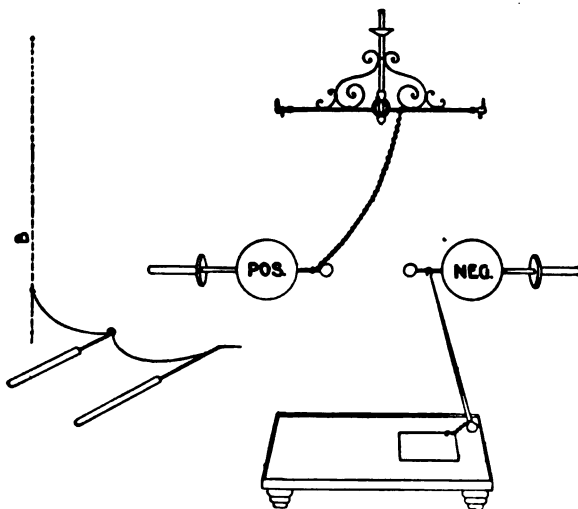

INDIRECT POSITIVE (SMALL) SPRAY.

is the negative direct or primary spray. If the electrode is moved away until only a current of electrified air is drawn to the patient, it is called a breeze. A breeze is a mild kind of a spray. For a positive direct or primary spray connect the negative side of the machine with the platform, and the positive side with the electrode. If a ball electrode is used the result will be the passage of direct or primary sparks.

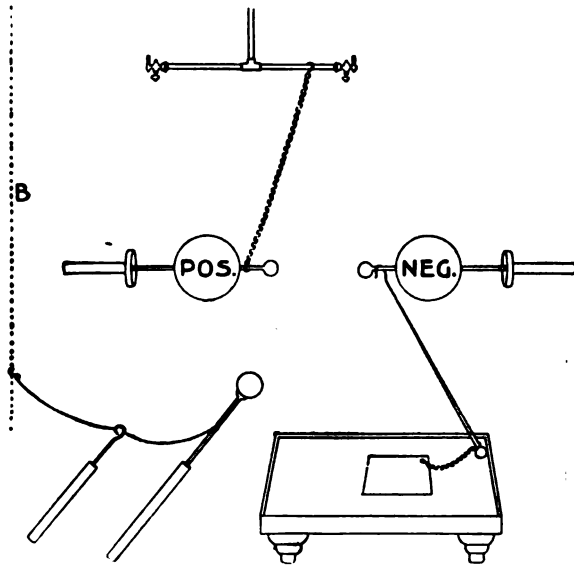

INDIRECT POSITIVE SPARK.

Indirect or Secondary Spray and Breeze (positive or negative).—Ground the positive side and connect the negative side with the platform. The platform and the patient are charged negatively. By induction the room (walls, table, etc., etc.) is charged positively, the air intervening between patient and room being like the dielectric (glass) of a Leyden jar. Place a metal stand on the floor and connect this stand with the earth. By connecting the small crown (multiple point) electrode with the stand, the elec-

trode will be charged with positive electricity, which, with the electrode held at the proper distance from the patient's body, will yield a positive spray, or, if moved farther away, a breeze. If there is a gas-fixture in the room, no stand is needed. The electrode is connected directly with the gas-fixture. This is what is called a *positive indirect* or *secondary spray* or *breeze*. To give a negative indirect or secondary spray or breeze, reverse the conditions. If instead of a crown (multiple point) electrode, a ball electrode is used, the tendency will be toward the formation of sparks instead of a spray. Sparks thus obtained are known as (positive or negative) indirect or secondary sparks. The potential of these sparks can be very much increased if the Leyden jars are included in the circuit, their outer armatures being connected (short-circuited) by a wire or rod which passes from outer coating to outer coating. In this way charges of high potential are bound by the inner coatings (armatures), the charges being released when a spark passes between electrode and patient. The same holds good in regard to the direct or primary sparks.

In all the applications named there is an air-space between patient and electrode which must be bridged over before the circuit is completed. In this respect the applications named differ from those which follow, the circuit in the latter not being broken between electrode and patient, but at some other point in the circuit.

The Static Induced Current.—Reference to this current has already been made. The Leyden jars are in the circuit. The cords are attached to the binding posts connecting with the outer armatures of the Leyden jars and the patient is placed in the circuit. The platform is not needed. The electrodes are in contact with the patient's body. The gap to be bridged over is between the sliding rods, the potential of the current being dependent on the length of the spark.

Potential Alternations (surging).—Make all the connections for a positive insulation, adding, however, a separate stand, which is grounded and placed in such a posi-

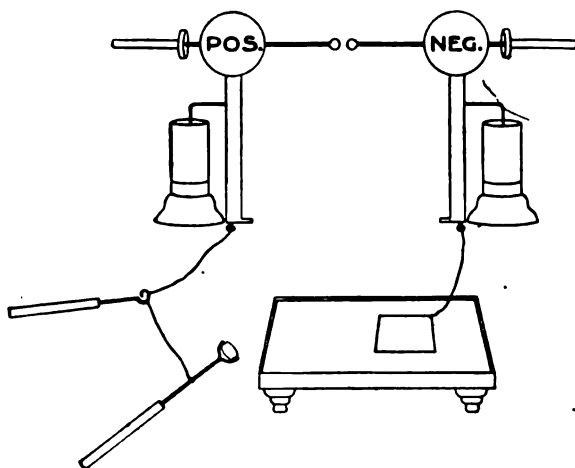

THE STATIC INDUCED CURRENT.
Application with the roller is shown.

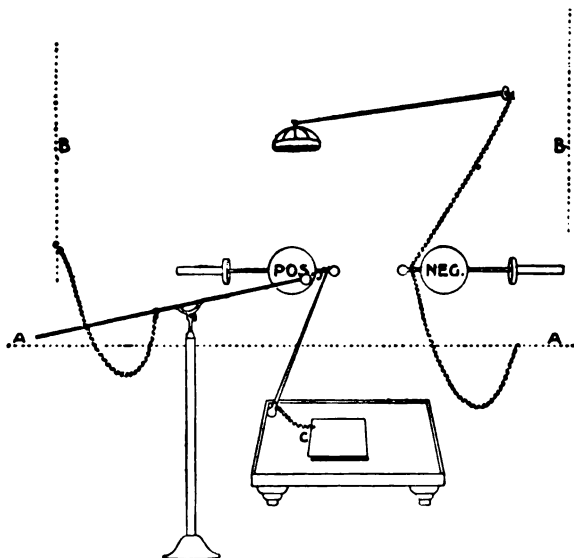

POTENTIAL ALTERNATION (MONELL, MORTON).

tion that a spark-gap is created between the positive sliding rod and a horizontal metal bar held by the grounded stand. The sliding rods of the machine are separated. The spark passes between the positive sliding rod and the rod

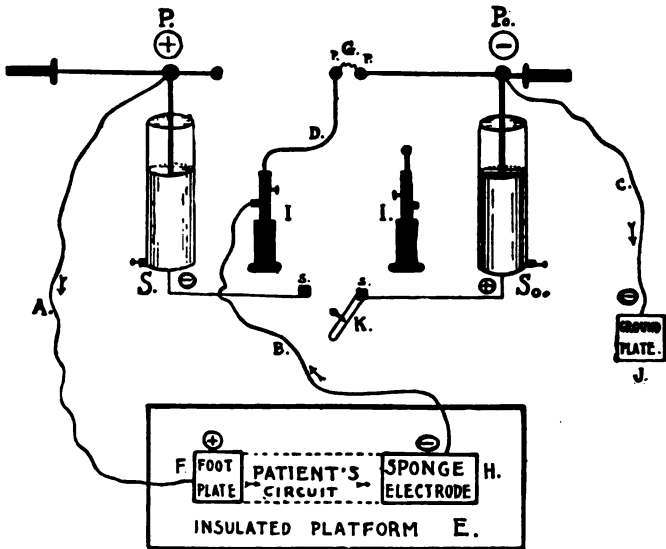

POTENTIAL ALTERNATION (MODIFIED).

A is a wire connecting the positive side (P) with the foot-plate (F). C is a ground-wire from the negative side of the machine (Po to J). D is a curved insulated rod held by a post (I) and connected (B) with a wet sponge-pad (H), which is applied to the bare skin. G is a spark-gap which is closed or opened by moving the sliding rod Po. If the Leyden jars are in the circuit the effect is more marked. It can be still more enhanced if the static induced current is short-circuited (connect outer armatures S and S_o by closing switch K). By alternately opening and closing spark-gap G a surging effect is produced. This form of potential alternation is useful in rheumatism and for the relief of pain generally. It is effective in muscular and nervous weakness, sexual neurasthenia, dysmenorrhœa, etc., etc.

held by the grounded stand. Whenever a spark passes from the positive sliding rod to the earth, the patient will be traversed by an oscillating current. The arrangement spoken of was first used by S. H. Monell. Morton changed

it by substituting a spark-gap electrode to be held by the operator's hand for the arrangement suggested by Monell. More recent modifications are shown in the accompanying diagrams.

The Morton Wave-current is named after Dr. W. J.

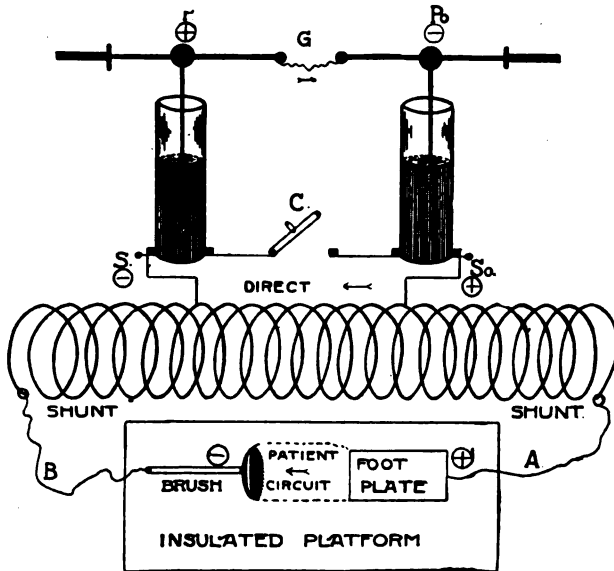

POTENTIAL ALTERNATION (MODIFIED).

The static induced current is short-circuited, not by closing the switch (C), but by connecting the outer armatures (S and So) with a solenoid, the two ends of which are connected (A and B) with foot-plate and electrode. The middle third of the solenoid is a part of the closed static induced circuit. When a spark passes at G the two outer thirds of the solenoid carry shunt-currents to the electrode and patient respectively. This form of application improves local nutrition and has marked anodyne properties.

Morton, of New York, who in 1899 gave explicit directions concerning this application. The spark-gap is between the sliding-rods. The negative side is grounded, the positive side is connected with the platform upon which the patient is sitting or standing, the strength of the current

is controlled by the spark-gap. If a local application is to be made, a piece of block tin of proper size is firmly placed on the skin of the part to be treated. The tin is connected with the positive side of the machine. Several pieces of block tin may be used on several parts of the body at the same time. Each piece must be directly connected with the positive side of the machine.

Since everything depends on the proper execution of the details of static treatments, it behooves the operator to become proficient in the technique of the different modes of application mentioned. Nothing equals the educational advantages of self-treatment for experimental purposes.

High-Frequency Apparatus.

Reference has been repeatedly made to the subject of high-frequency currents. They are *currents characterized by a high frequency of oscillations (alternations)*. Next to the constant (galvanic) current it is the currents of high frequency that are of superior therapeutic value and, therefore, entitled to detailed consideration.

The Question of Amperage.—In order to understand some of the remarkable effects produced by currents of high frequency, it is necessary to think of some of the elementary principles of electro-physics. Owing to the tremendous pressure of a current of this kind, the rate at which the current flows, is very rapid. One coulomb of electricity passing through a conductor in one second is called an ampere of electricity. If the pressure is great enough to force one coulomb through the conductor in one-tenth of a second, the quantity passing in one second would be 10 amperes. If one coulomb were to pass in the hundredth part of a second, the current-strength would be 100 amperes. If a current of this kind were to flow in one direction it would be most dangerous to life. These currents, however, are alternating and the alternations are so rapid that the sensory nervous system seems to be unable to respond to them. This fact

makes these currents safe to use. The lower the frequency, the more dangerous the current.

Phenomena of Induction.—The wonderful effects produced by induction in secondary conductors will be better understood by a careful consideration of the subject of induction which has been discussed in connection with the



LOUDIN RESONATOR.

physics of the faradic induction-coil. The electro-motive force in the secondary coil depends on the number of turns in the primary coil and on the frequency of the interruptions of the current in the primary coil. Every interruption, it will be remembered, is coincident with a change in the direction of the current. Let us suppose that an alternating cur-

APPLICAZIONE DI UNO DEI SISTEMI.

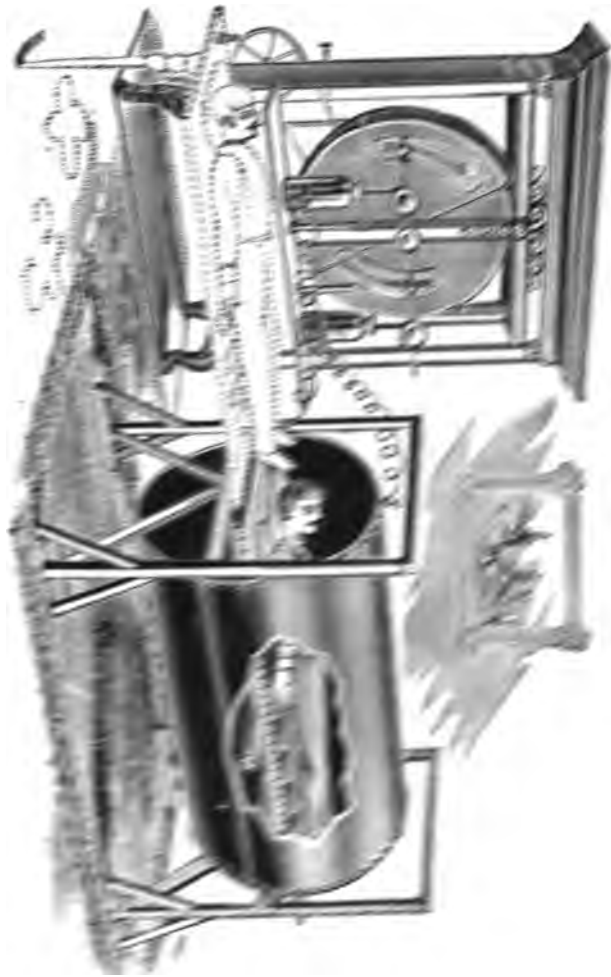

rent of two amperes and a frequency of 1,000,000 is circulating in a primary wire consisting of two convolutions of wire. Let us place a solenoid (a cylindrical coil of wire with circular convolutions) in the magnetic field of the primary wire. The effect on this solenoid would be the same as if 200 amperes were circulating in a primary coil of 200 convolutions with a frequency of 100 alternations. The effect on the solenoid depends on the product of the amperage and frequency in the primary wire. In this way the remarkable effects of induction of high-frequency currents can be explained, *e. g.* the lighting of an incandescent lamp attached to a wire held near the conductor of a high-frequency current.

Resonance Effects.—The waves of electrified ethereal molecules which emanate from a current of high frequency are capable of causing electric oscillations in another circuit which is of the same kind or has a direct physical relation to it. The second circuit responds just as a string of proper length and thickness will vibrate in sympathy with some other string which has been set in motion. The physical relation between these two strings is that they be of the same length and thickness or that the length and thickness of the second string be a simple fraction or a multiple thereof. Thus, the term “resonance” has an analogous meaning in electricity and is borrowed from acoustics to express this analogy. The high-frequency instrument which in its construction is based on this phenomenon of “resonance,” is called a resonator.

The instrument, device or apparatus by means of which high-frequency currents are generated, are principally the high-frequency coil of D'Arsonval and the resonator of Oudin. The solenoids which can be attached to an alternating light-circuit or the diasolenic cylinders which can be attached to a static machine are very useful and convenient. The Tesla coil as a therapeutic instrument is hardly ever used at present.

The High-Frequency Coil was originated by D'Arson-

VACUUM ELECTRODES.

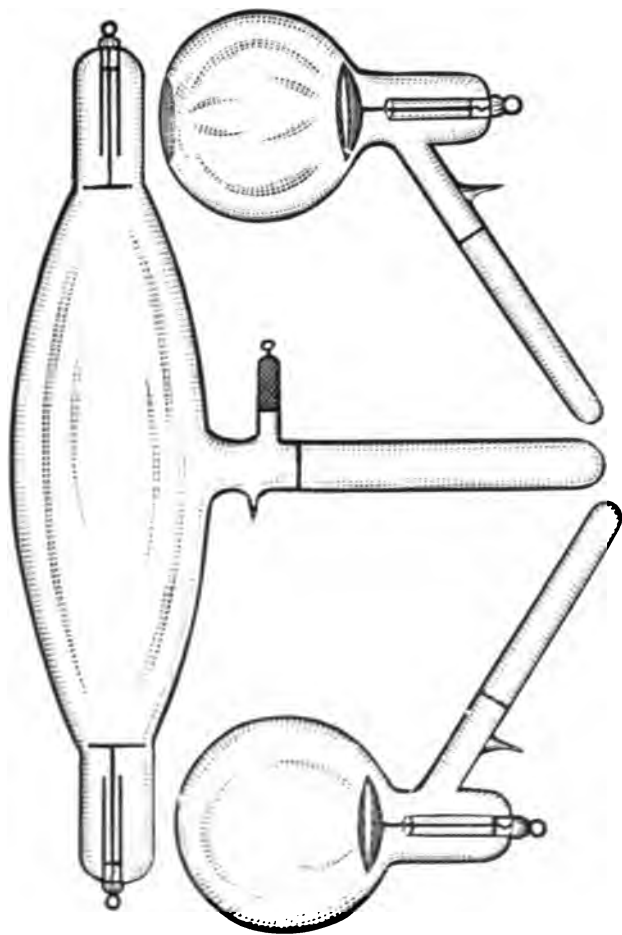

val and is available in conjunction with a static machine or an X-ray coil. It consists of a solenoid which is in the circuit of the outer coatings of the Leyden jars. Around the solenoid a secondary coil is placed which receives the current from the primary coil (solenoid) by induction. The whole arrangement is incased in a box. The binding posts on top connect with the terminals of the secondary coil while the binding posts on the end or on the side of the box connect with the terminals of the solenoid which in this way can be connected with the outer armatures of the Leyden jars. The spark-gap to regulate the amount of current is between the sliding rods of the static machine. If an X-ray coil is used as a generator of the current a condenser is interposed between the X-ray coil and the high-frequency coil. The condenser plays the part of an accumulator analogous to the inner armatures of the Leyden jars. The current from a D'Arsonval high-frequency coil is applied by means of suitable (glass, metal, condensing) electrodes.

The Resonator, originated by Oudin, consists of a solenoid of which only a part is in the Leyden jar circuit, the remaining portion receiving its electric energy by resonance (see above) and by induction. The larger the portion of the solenoid which is in the circuit, the greater the amount of energy and the higher the frequency. The electrodes used are glass, metal or so-called condensing electrodes.

The Condensation Couch consists of a sofa or lounge upon which the patient lies down. The couch is connected with one terminal of a solenoid while the patient is connected with the other terminal. The solenoid is in the circuit circulating between the outer armatures of two Leyden jars. The connection between solenoid and couch is by means of a wire which is attached to a metal plate on the couch. The connection with the patient may be made by means of a wire and metal handle held by the patient. The patient lies on a cushion, beneath which the metal plate is put. The constant change of polarity in the rapidly oscillating discharges of the Leyden jars causes a coincident

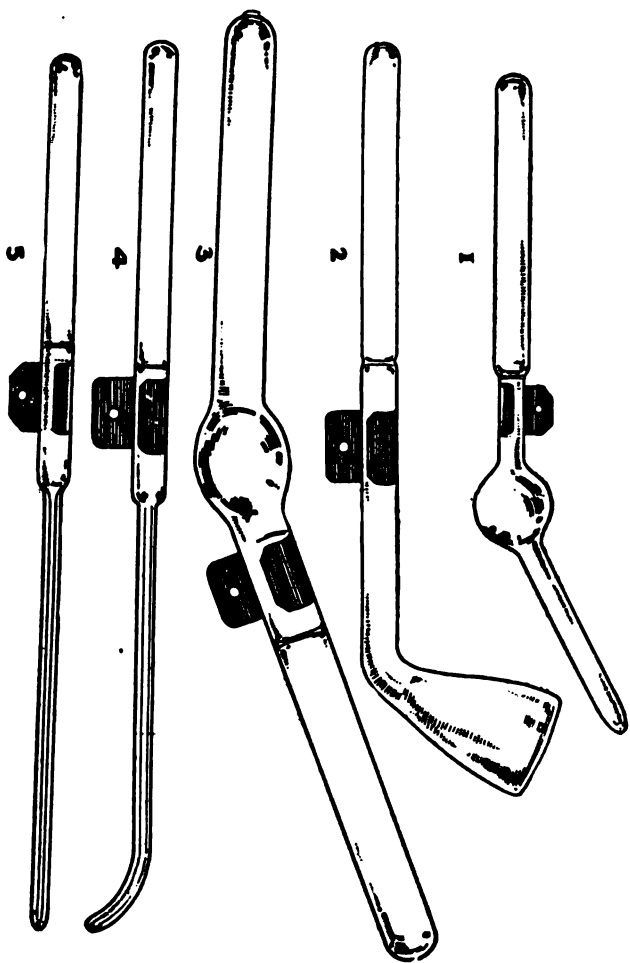

VACUUM ELECTRODES.

- 1. Rectal.
- 2. Surface.
- 3. Vaginal.
- 4. Urethral.
- 5. Cavity.

change in the patient and the lounge, resulting in a rapid and continuous back and forth surging of high-frequency charges.

The Auto-conduction Cage is a solenoid of immense size in which the patient stands. The solenoid is in the circuit of two Leyden jars, the patient's body constantly receiving induction-charges of high frequency.

The Diasolenic Cylinder, ("dia" through, "solen" cylinder,) suggested by the author, is a combination of the principles of condensation and auto-conduction. The cylinder is an immense solenoid which is connected with the outer armature of a Leyden jar. The platform upon which the patient lies is connected with the outer armature of the other Leyden jar. The spark-gap is between the sliding rods of a static machine. A rapid change of polarity takes place in the platform, in the cylinder and in the patient's body. While the current is circulating, charges and inductive influences of high frequency and potential constantly surge to and fro in the patient's body. Some operators connect cylinder and platform with one side of the machine while the other side is grounded.

The *high-frequency electrodes* are either glass (vacuum), metal or condensers. Condensing electrodes are made of hollow glass, filled with pulverized graphite or having an inner coating of tin-foil. The electric charge is received and condensed by the inner coating or graphite-powder and an induced charge is produced in the tissues of the patient which represent the outer coating (analogous to a Leyden jar). The *metal* electrodes have a small bulb or ball on the end and are supplied with an insulated handle. The vacuum-electrodes consist of partially exhausted glass tubes, the color of the light in the tubes depending on the condition of the vacuum. These electrodes are applied to the skin directly. A very useful set of vacuum-electrodes with one universal handle has been devised by Dr. W. B. Snow, of New York.

So much for the physics and mechanics of medical elec-

tricity. The electro-therapeutic achievements of the past have been chiefly along the line of galvanic electricity. The success of the future in an electro-therapeutic direction promises to be in the elaboration of the wonderful possibilities offered by currents of high frequency.

CHAPTER IX.

THERAPEUTIC USES OF GALVANIC, FARADIC, STATIC AND HIGH-FREQUENCY CURRENTS.

THE subject of medical electricity, more especially the part of the subject which refers to the action of electrical currents on animal tissue, has been encumbered with much unnecessary detail, theoretical speculation and a well-nigh endless list of distinctions, classifications and subdivisions. This fact, in and of itself, seems to be sufficient to show that the professional mind is by no means clear in regard to the principles of electro-therapy. The subtle and undefined character of electrical agencies in conjunction with the mysteries of neuro-physiology and neuro-pathology offers a vast territory for speculation and hypothetical reasoning. Abstracting from that which is purely theoretical and of interest to the laboratory-physiologist rather than the clinician, it seems reasonable to recognize two kinds of effects which electrical currents might be able to produce on and in the animal-body.

If the molecules individually and collectively are disturbed in their position and relation, if their nutrition is increased, diminished or altered, if function is stimulated or depressed, such an effect might be attributed to a *physiological* action. This would be a generic term, covering thermal, magnetic, electrotonic, physical, somatic, mechanical and many other kinds of effects referred to in the text-books. The salient point is that these effects consist in modes of action that are strictly in accord with the physiological intentions expressed in the activity of organic matter. There is

no impairment of structural perfection. The molecule is neither physically incapacitated nor chemically disintegrated. In keeping with these facts, the salient point of these physiological effects might be expressed and emphasized by designating them as *non-destructive*. They affect function by altering structure within physiological limitations.

Another variety of effects would be produced by the action of electrical currents on structure, altering or destroying the latter by disintegrating its chemical constituents or changing the proportion of the latter. These effects would be *chemical*, or *destructive* in a physiological sense. The electrolytic action of a galvano-puncture would be a chemical effect, while the stimulation of the vaso-motors by means of a negative static application would be distinctly a physiological effect.

In keeping with the division given we may recognize *physiological* and *chemical* effects as following the employment of the galvanic current.

Physiological Effects of the Galvanic Current.

The galvanic current seems to have an affinity for nerve-structure. The individual neurons seem to gratefully respond to the gentle and evenly flowing stimulant. In the order of their response to a mild galvanic current the motor nerves seem to react less promptly than the sensory nerves, and these again with less precision than the vaso-motor (sympathetic, trophic) nerves. The latter show the deep impression which even a comparatively mild galvanic current is capable of producing, by the marked changes in the circulation and in the nutrition of the regions treated. The electrical tendency is toward the negative pole. Thus, there is an over-stimulation toward the negative pole and a compensatory under-stimulation at the positive pole. The vessels dilate near the negative pole, whereas there is a distinct contraction of the arteries at the positive pole. In keeping with the physiological law

which makes function dependent on nutrition and, therefore, on circulation, it is but natural to see increased functional activity, augmented metabolism, accelerated oxidation, intensified absorption at the negative side and the opposite state of affairs (sluggishness of functional action) at the positive pole. The decrease in the amount of blood at the positive side lessens blood-pressure. This fact makes *the positive pole a sedative and an anodyne* of great value. The increased functional activity at the negative pole soon reaches the physiological limit. The effects of overstimulation become apparent. The skin is red and irritated, the whole region hyperemic and on the verge of an inflammatory action. The trophic nerves have expended their force in response to the current. The physiological effects described explain the subjective symptoms which accompany an application of this kind. The patient experiences a sensation of heat or burning at the negative side while the positive side feels numb.

It is primarily the effect of a mild galvanic current on the trophic nerves, and through these on the blood-vessels and lymphatics, which accounts for the markedly absorbent action of the galvanic current. This action alone is frequently sufficient to account for the disappearance of hypertrophies, morbid growths and effusions after galvanic applications.

In giving galvanic treatments the current should not be abruptly interrupted unless a special effect is desired. Subjectively a sudden interruption produces an exceedingly disagreeable sensation, especially if the application is made on or near the head or chest. A sudden interruption of the galvanic current acts mechanically on the muscular tissue at and near the seat of application. The muscles contract violently. In asthenic and atrophic conditions of the muscles and in paralytic and paretic states generally, these interruptions of a galvanic current are very effective, especially if they are slowly and rhythmically applied. In these coarse, violent applications the operator can be guided en-

tirely by the mechanical effects produced. At all other times it is advisable to follow the indications of the milliamperemeter.

Mild galvanization (one to five milliamperes) of a special nerve or set of nerves is one of the neatest and best electro-therapeutic applications, especially if the operator is dealing with a clearly diagnosed condition of functional impairment or of pain. In many so-called reflex conditions the galvanic current is of great value. Reflex conditions are always due to a lack of balance on the part of portions of the nervous system, a disturbance of co-ordination. A nerve-impulse may travel over a nerve-trunk or through a series of neurons simply by following the path of least resistance. The lack of resistance is a functional ailment of some special nerve-structure. A functional disorder of a nerve is always an indication of malnutrition, usually lack of nutriment or the wrong kind of nutriment. The nerve, as a result, is functionally below par and possesses less than its normal resisting-power. This explains the causation of reflex neuroses, of neuralgias and many obscure nervous disorders.

The vomiting of pregnancy is a classical type of a reflex condition. The impulse is carried by fibers of the solar plexus in response to impressions received by some of the lower abdominal nerve-ganglia. The nerves of the solar plexus are temporarily ill-nourished on account of the physiological hyperemia in and near the internal genitalia, and in this way these nerve-fibers present the path of least resistance. In these cases it is of signal service to compensate for the lack of nerve-energy by mild galvanization of the vagus and phrenic (side of neck positive pole, epigastrium negative pole).

In facial neuralgia, in fact in all superficial neuralgias, mild galvanization often gives prompt relief. The positive pole should be placed on or near the aching part. The negative pole should be put on some point in the continuity of

the nerve or, if practicable, near the spinal origin of the nerve.

In congestive headaches good effects are produced by placing the positive (sponge) electrode on the forehead and the negative (sponge) on the back of the neck or lower down, at the same time making firm pressure on either side of the occiput and back of the neck. A mild galvanic current can be thus applied for three to five minutes. To insure good electrical contact, sponge-electrodes should always be thoroughly moistened.

General galvanization by means of a mild galvanic current is valuable in all conditions in which a mild tonic-stimulant is indicated, *e. g.* neurasthenia, wasting diseases, convalescence from continued fevers, etc., etc. The negative electrode is placed over the lumbar vertebræ and slowly moved upwards, while the positive electrode is slowly carried over the whole body-surface. The treatment should not last longer than ten minutes. In the atonic form of gastric and intestinal indigestion mild galvanization of the abdominal contents is of great value. In all these applications the operator should not carry the treatment to the point of irritation. It is plain that in many of the conditions to which mild galvanization is applicable, the effect can be enhanced by the discreet addition of massage. All these physiological effects are included under the general head of *catalysis*.

Chemical Effects of the Galvanic Current.

When the point of irritation has been reached in making an application of a galvanic current, certain changes occur in the tissues and fluids of the body, the severity of these changes depending on the duration of the application, on the amperage of the current used and on the pole used. The changes may consist in an actual destruction wrought by electro-chemical decomposition (electrolysis) or in chemical alterations due to the introduction of chemical agents into the tissues and fluids of the body (*cataphoresis, metallic electrolysis*).

POSITIVE (ANODAL) ELECTROLYSIS.—This designation comprises certain effects which occur near the positive pole of a galvanic current applied to the tissues. If a needle is inserted into a piece of raw meat and a galvanic current of about 10 m. a. is allowed to pass with the needle as its positive pole, the needle will soon be found to stick fast. The point of insertion will look dry, white and shrunken. If the needle is made of iron, steel, copper or any other oxidizable material, the needle will be oxidized and an oxide of the metal will be deposited around the point of insertion of the

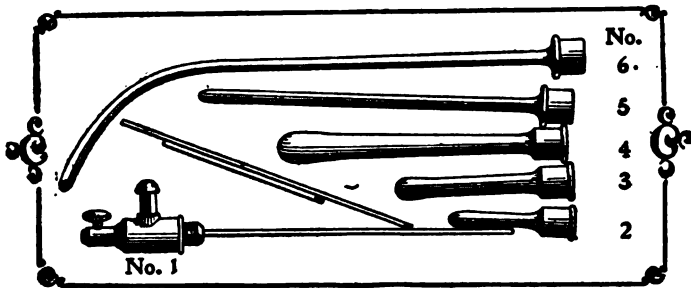

ELECTRODES FOR POSITIVE ELECTROLYSIS IN CAVITIES.

No. 1 is the universal holder. Nos. 2, 3, 4, 5, and 6 are hard rubber tips which fit on the holder. They slip over the copper wire, which is a part of the holder, and are introduced into the cavity where treatment is to be given. The cavity is filled with normal salt solution. Tips of all sizes and shapes are made.

needle, causing a staining of the tissues. If the current is strong enough, the stain is permanent. The positive pole has an affinity for oxygen and for acids. The latter coagulate the tissue-albumen and in this way interfere with the blood-circulation. This explains the styptic action of the positive pole. After the application has been made, the current is turned off and reversed. In this way the electrode used for positive electrolysis is released and can be easily removed.

The electro-chemical destruction of tissue makes the

positive pole available in the treatment of various conditions, to wit:

1. *Growths consisting of dilated capillaries* (angiomata, birth-marks, cirroid aneurism, varices, acne rosacea, etc.). One or more needles representing the positive pole of a galvanic current are introduced into the growth until the coagulating and styptic effect has been produced. The negative pole is put in an indifferent place.

2. *Growths of soft texture* (moles, polypi, fungi, warts, etc.) can be cured by cutting off the blood-supply, the instrument used being one or more needles.

3. *Hemorrhage*, active or passive, especially from turgescient mucous membranes, can be stopped by the positive pole, the application being made by means of a flat electrode. This application is available in gynecological practice to stop bleeding from the endometrium (by means of an intra-uterine electrode). Infected areas (lupus, tinea, etc.) are often successfully treated by positive electrolysis. It is well to know that gonorrhoea, especially in the post-acute form, can be checked by positive electrolysis. The gonococcus can not withstand the action of the current and soon becomes non-viable.

NEGATIVE (CATHODAL) ELECTROLYSIS.—The negative pole of a galvanic current attracts hydrogen and alkalies. If a needle, charged negatively, is thrust into raw meat, the needle will not stick. A whitish foam will issue from the point of insertion of the needle, the foam being composed of bubbles of hydrogen. The tissues near the point of insertion are softened and even liquefied. Therapeutically the process of destruction set up by negative galvanic electricity can be utilized in the treatment of manifold conditions, to wit:

Superfluous Hairs.—The patient holds a metal-handle electrode in his hand. The other electrode is a fine needle which is introduced into the canal from which the hair emerges and the current is turned on, the needle-electrode being charged negatively, the handle-electrode positively.

The object is to destroy the matrix of the hair-follicle. As soon as a little whitish foam is seen to issue from the point of insertion of the needle, the current is turned off and the needle withdrawn. The hair is readily taken out by means of a suitable forceps. If the application is properly made the hair will not grow again.

Cicatrices.—Scar-tissue resulting from burns, inflammations or various traumatic conditions, can be softened and stretched by negative electrolysis. In cicatricial strictures of an accessible canal this method is indicated. It is the ideal way of handling *urethral strictures* in the male. Robert Newman, whose name will for all time to come be associated with this branch of conservative surgery, gives the following directions as to the *modus operandi*:

The urethral electrode to be used should consist of one piece. The tips to be screwed to a universal handle are to be condemned because they are likely to come off as shown by a number of cases of this kind. Electrolysis must be confined to organic strictures. Spasmodic strictures are likely to be aggravated by this mode of treatment. The instruments should be clean. In lubricating the urethral electrode of proper size before inserting it, remember that the lubricant should be a conductor. Use glycerine or white of egg; avoid oil or vaseline. Let the patient stand, sit or lie down according to his sense of comfort. Let him hold the (positive) handle-electrode in his hand. Introduce the (negative) urethral electrode until it is arrested by the first stricture. Turn on the current. Guide the electrode, never use any force or pressure. The electrolytic action will soon enlarge the caliber of the urethra, enabling the instrument to advance slowly and pass the obstruction. If another stricture exists, proceed in precisely the same manner. When the canal is clear and open, turn off the current and withdraw the instrument. Never use more than five or six milliamperes of current. Watch the milliamperemeter carefully. Remember that electrolysis is a species of absorption. It means neither cauterization, nor heat, nor dilatation, nor divul-

sion. The electrode should have a short curve. Begin and end the operation without current, *i. e.* turn the current on and off after the instrument has been introduced and before it is withdrawn. The operation can be repeated in a week. Never use more than one instrument during one treatment. Remember that electrolysis will cure nearly every organic stricture of the urethra. Bad results are always attributable to faulty technique or mistaken judgment. Electrolysis of a urethral stricture should be bloodless, painless and productive of a quick and good result. (Robert Newman's record is a list of more than 2,500 cases without a single failure.) It is proper to add that negative electrolysis has been used to great advantage in cases of dysmenorrhea caused by stenosis of the cervical canal.

Epithelial Hypertrophies, Warts, Fungi, Papillomata, etc.—If a (negatively charged) needle is used, it should be inserted on a level of the skin or mucous membrane, the growth, if possible, being slightly raised by means of a suitable forceps. The growth is pierced and the current turned on. When electrolytic action is complete, the current is turned off and the needle removed. Another insertion at right angles to the first is made. Sometimes it is of advantage to use two or more needles at the same time by means of a suitable needle-holder. Different shapes of electrodes are often serviceable. On general principles it may be said that negative electrolysis is preferable in the non-vascular variety of hypertrophies and growths while positive electrolysis is better adapted to vascular growths where the cure is accomplished by obliteration of the vessels.

Growths of the Connective Tissue Type (Fibromata, etc). The application is made by means of a suitable needle if the growth is easy of access, otherwise by means of a flat electrode placed on the skin directly over the growth. The possibilities of this method in cases of uterine fibroids (subserous, intramural, submucous, more especially the former two) have been amply demonstrated by Apostoli and his pupils. The usual mode of application consists in putting a

(negative) flat abdominal pad-electrode directly over the growth with a suitable (positive) electrode in the vagina. Apostoli inserted a (negative) intra-uterine electrode and placed a (positive) flat electrode on the abdomen. He employed 50 to 250 milliamperes of current. In cases of easily accessible growths (submucous fibroids, polypi, etc.) he often used a needle or trocar charged negatively. The treatments are given every day or every other day for ten to fifteen minutes. In cases of goitre, negative electrolysis may be used, two sponge-electrodes being placed on the growth. Sometimes it is of advantage to put the negative electrode on the growth and the positive electrode in some indifferent place. The needle has been used successfully, but requires considerable technical skill and experience on the part of the operator.

Bony and Cartilaginous Growths.—Negative electrolysis is effective in removing bony outgrowths in the nasal fossa and in correcting deviations of the septum. By inserting a (negative) needle of suitable size into the substance of an accessible osteoma, exostosis, enchondroma or enchondrosis anywhere in the body, disintegration of the growth can often be effected.

METALLIC ELECTROLYSIS is the employment of an electrode made of some metallic substance capable of forming chemical compounds by uniting with the ions at the positive or negative pole. It differs from cataphoresis pure and simple because in the latter chemical substances *en masse* are introduced into the tissues of the body, whereas in metallic electrolysis the chemical substance is formed by a distinct chemical process which is set up by the use of a suitable metallic electrode. Thus, by using a positive electrode made of pure copper or pure zinc, oxides and chlorides of copper and zinc are formed by the action of oxygen and chlorine on the copper and zinc of the electrode. This therapeutic use of galvanism has been elaborated by many operators recently, and is available for a variety of clinical purposes.

An interesting form of metallic electrolysis is the use of

the zinc-mercury amalgam electrode at the positive pole, championed by G. Betton Massey. The action of the chemical products (oxychloride of zinc and mercury), formed by the acid ions attacking the amalgam, is "sterilizing and alterant and is destructive to low forms of tissue." This mode of treatment is indicated in cases of local sepsis (sterilizing effect), of passive congestions (alterant effect) and in cases of cancer (destructive action). Gynecological practice seems to offer a vast field of usefulness for this method. Metallic electrolysis as well as simple (positive and negative) electrolysis are much-neglected branches of conservative or, in not a few instances, of palliative surgery. Many an inoperable case (*e. g.* osteo-sarcoma of the upper jaw) could be subjected to electrolysis and benefited. The electric current is in these cases a more humane and a more easily managed agent than the knife.

CATAPHORESIS.—The introduction of chemical agents (drugs) into the body by means of an electric current is called cataphoresis. The only current available for this purpose is the galvanic current. A sponge-electrode or piece of cotton is saturated with a liquid preparation of the drug and put on the skin. Very convenient cataphoric electrodes have been placed on the market which simplify the technique very much. The operator must know the electric affinity of the drug he is using. If the atoms of the substance he is using are attracted by the positive or negative pole of the current, the substance is said to be electro-positive or electro-negative, as the case may be. In making a cataphoric application, electro-positive substances must be used with the negative pole and *vice versa*. Thus, iodine being attracted by the positive pole, is applied by means of the negative pole. The positive pole is placed at some distance. The moment the current is turned on, the atoms of iodine will travel toward the positive pole. Cocaine and all alkaloids are attracted by the negative and should, therefore, be applied under the positive pole. Iodide of potash and all halogen salts are applied under the negative pole, to be drawn

toward the positive pole. For local anæsthesia the cataphoric application of cocaine deserves to be better known and more frequently used than it is, especially in minor and in dental surgery.

ELECTRODES.—The shape, style, size and general construction of the electrodes used in the application of the various modes of administering galvanic electricity should be prompted by the purpose to which the electrodes are to be adapted. The surface to be treated and the canal or cavity to be invaded should call for certain shapes and sizes of electrodes. To enumerate them would be an endless task. The catalogues issued by the manufacturers of these goods are the best source of information. The principal and most important feature of an electrode is that it delivers current to the body without offering too much resistance. The electrical contact between electrode and skin should be perfect. If sponges are used, they should be wet. Water is an excellent conductor. For this reason the complete or partial bath is frequently used as a means of administering electrical treatments. The region to be treated is immersed in the water, which plays the part of the electrode. A metal plate in the water is connected with one pole of the battery, the other pole (*e. g.* sponge) being held by the patient or an attendant, who applies it to some part which is not in contact with the water. The technique is simple, the physiological action being in accordance with the principles outlined above. The immersion in medicated water is a splendid mode of administering cataphoresis. On general principles direct metal contact with the skin, *e. g.* the abdominal electrode, is not desirable. Contact is most effective and less irritating by means of a moist sponge, carbon, or by wet cloth wrapped around a metal electrode. Electro-therapeutic applications that are painful are of questionable utility unless pain is unavoidable. If pain can be avoided, it should be. Some of the best and most useful electro-therapeutic applications are painless because the amperage used is slight. Next to producing a good therapeutic result,

the operator should strive to adopt an agreeable mode of procedure, if such is at all possible. This is a point of some importance, because much of the pain and discomfort incidental to electro-therapeutic procedures, is needlessly inflicted and might be avoided by correct technique. Cleanliness is a necessary part of electro-therapeutic manipulations, especially with reference to the electrodes used. To use wet sponge-electrodes on one patient after another, is practically a cataphoresis of dirt and as such has no place in the armamentarium of a modern electro-therapist.

Faradism.

Compared to the therapeutic importance and usefulness of galvanic electricity, the faradic current dwindles into insignificance. Its therapeutic uses are suggested by the markedly excitant and stimulating action on muscular tissue. In response to a faradic current muscular fibers contract more or less violently. This means physiological activity for the contracted fibers and involves increased local oxidation and metabolism. The muscle-fiber requires more blood after exercise of this kind to furnish the oxygen required. In this way more nutriment is carried to the muscle, and the latter improves both in functional power and in substance. The faradic current, therefore, is a muscular tonic within physiological limitations, *i. e.* if the exercise produced by the current is not overdone and if the blood drawn to the active muscle is of good nutrient quality. The exercise involved in faradic contraction of muscle-tissue must not be carried to the point of fatigue or exhaustion of the fibers. It must not bruise or jar them, but must be closely in imitation of physiological muscle-exercise. Only then will the distinctly tonic effect of the faradic current become manifest. Spasmodic contractions of muscle, *e. g.* cramps in the extremities or the spasmodic form of dysmenorrhea, are always due to some perversion of the functional activity of the nerves controlling the muscles affected. Since functional nerve-diseases *per se* do not exist but are always produced

by some unidentified change in the structure and mutual relation of the neurons, and are, for this reason, diseases of local nutrition, it is plain that the methodical use of the faradic current under these circumstances has a logical therapeutic significance. It is a *tonic* in the proper sense of the word. It improves the *tone* of muscle tissue by altering, *i. e.* by improving the local nutrition. In this way it counteracts spasm because the latter is due to a lack of tone of the muscle or control of the muscle-function through the nerve-supply. It stands to reason that the intensity of the tonic effect of a faradic current will depend on the extent of the area treated and on the relative adaptability of the current to take the place of physiological exercise. A mild faradic current administered to a patient sitting in a bath-tub, the water reaching to the costal border (one pole in the water, the other applied to the neck, chest and back by means of a sponge-electrode), ought to—other things being equal—produce a fine, gentle stimulating effect. There must be no pain, only a gentle tingling. Through the muscular tissue the current is bound to affect contiguous structures.

The faradic current is useful in cases of redundant panniculus adiposus in the abdominal wall. It improves the quality of the muscular tissue of the abdominal wall at the expense of the fatty layer. It stimulates the muscular fibers in the walls of the intestines and is, therefore, of value in the treatment of atony and dilatation of the stomach and bowels. In rectocele, cystocele, prolapsus, in fact in all conditions produced and aggravated by loss of muscular tone, the faradic current does very well. It enhances the effect of massage and may be combined with massage by causing one electrode to be held by the patient, the other by the unengaged hand of the operator. This is a splendid addition to the technique of Thure Brandt massage. The use of the rectal electrode is of great benefit in the treatment of hysteria. The apparent anodyne action of a faradic current in neuralgic cases (*e. g.* sciatica) is due to its alterant action on the muscular tissue and through the latter on the

circulation. The blood-supply is regenerated and the cry of the nerve for healthy blood is stilled. The use of violent faradic shocks is never indicated except in paralytic conditions where it is a question of making an impression on tissue that has hardly any vitality left in it. Painful applications of the faradic current are never proper.

Owing to the fact that the faradic current is an alternating current, it is of little consequence which pole is used. Polarity, which is everything in galvanic and static electricity, is of no consequence in faradic applications. For obvious reasons, the faradic current can not be used for electrolysis or cataphoresis. What has been said concerning the electrodes used in applications of the galvanic current, might be repeated in regard to faradic applications. There are, however, fewer electrodes required because the therapeutic field of the faradic current is small compared to that of galvanic electricity.

Static Electricity.

"Static electricity is adapted to the scientific treatment of all diseases."

"Static electricity, if administered by a judicious and skilled operator, is a valuable adjunct in the treatment of many chronic diseases."

"Static electricity is a suggestive agent of no inconsiderable efficacy."

These three statements, quoted from three different medical text-books, represent the three camps into which the profession is divided on the subject of static electricity. The morbid enthusiast sprays and sparks his patients for every ill to which human flesh is heir. The skeptic who knows nothing about the subject, but assumes an *ex cathedra* tone in his denunciation, sees nothing but the suggestive influence of ponderous machinery and mysterious performance. Both the enthusiast and the skeptic are at fault. The former is usually deficient in his knowledge of general medicine, while the latter is positively ignorant about the

static machine and its legitimate sphere of usefulness. That this sphere of usefulness is much smaller than the popularity of the subject of static electricity would lead us to believe, is unquestionably a fact. Static electricity is far from being a panacea. In point of therapeutic value it does not rank with galvanic electricity, although it seems to be superior to faradic electricity. Its physiological indications, however, are less definite than those of either. There is a larger share of uncertainty and guesswork in the application of static electricity and a correspondingly greater portion of the suggestive element than in either galvanism or faradism. Yet static electricity possesses certain characteristic features of its own that make it valuable many times and actually invaluable sometimes. Therefore, the golden mean of conservatism expresses a fair estimate of the subject. There is no doubt that static electricity, if administered by a judicious and skilled operator, is a valuable adjunct in the treatment of many chronic diseases.

What effect has static electricity on living organisms? The life of man is spent within the magnetic field of the earth. The earth is a magnet rotating around its axis and surrounded by induced positive electricity, the earth being the negative element. The particles of solid matter floating in the atmosphere about us, the moisture and vapor that fills space in many degrees of density, are all charged positively. All vegetation, using the latter word in its vast biological sense and including the animal and the vegetable kingdoms, is a phenomenon dependent on, and influenced by, positive electrical charges. The researches conducted by S. Lénstrom at the physical laboratory of the University of Helsingfors and by expeditions under his direction in different parts of the world and under varying climatic and meteorological conditions, have demonstrated the influence of positive electricity on vegetative processes. The most interesting feature of his experiments is the fact that he used electricity produced by a Holtz machine with the negative side

vation of vitality and physical energy. Clinically this is true. Wherever and whenever a tonic-sedative is indicated, the positive insulation is the proper static application. Positive static electricity tends towards structural and functional preservation of organic tissue. In a much more emphatic sense this statement holds good when the potential of the positive current is raised by induction, *e. g.* by the use of Leyden jars. Thus the Morton wave-current may be classed as an agent which is capable of increasing the physiological resisting power of the part to which it is applied. It restores the metabolic equilibrium which is disturbed in all conditions characterized by increased venous and decreased arterial pressure. Passive congestions are removed by improving the physiological "tone" of the affected region. Pain is relieved because nutrition is rectified and toxic material turned into the proper excretory channels. Health has been defined "a condition characterized by perfect equilibrium of arterial and venous blood-pressure." Disturbance of this equilibrium results in locally increased arterial pressure (hyperemia, over-nutrition) or locally augmented venous pressure (anemia, under-nutrition), both conditions resulting in disturbed nutrition of the nerves whose cry for proper nutriment we call *pain*. Positive static electricity, especially of very high potential in restoring the physiological tone of the affected area, tends to re-establish the normal equipoise of the two forms of pressure and in this way counteract stasis and relieve pain. If the physiological tone of any region has been completely suspended and the life-principle is fighting for preservation under pathologic conditions (inflammation or its antipode "a-trophy" or lack of nutrition), positive electricity would be of no avail. All positive static application, including the wave-current, should be restricted to conditions which are characterized by lowered tone of the system or any part, *e. g.* nervous disorders, venous congestions, chronic inflammatory conditions. In making applications of this kind,

etiology and pathology mean everything. Symptoms have but little therapeutic significance.

It is of some importance and assuredly of considerable interest to know something about the physiological *modus operandi* in which static electricity acts upon the tissues of the body. Neiswanger states that the nerves of the human system are like tuning-forks which will respond to a certain number and strength of force-oscillations. The supposition is that the nervous system is made up of an unlimited number of "receivers," each one being capable of responding to a certain kind of a vibratory impulse. The author supposes that in giving a patient a static treatment, one or more nerves in the body are bound to vibrate in unison with the vibrating force-modalities that are reverberating through the system. It is plain that the explanation is neither physiologically nor therapeutically admissible.

The human body as a conductor of static electricity does not differ from other conductors in the manner in which it receives and stores this kind of energy. The latter accumulates on the surface of the conductor. It is the skin which is the real conductor, not the nerves nor any other structure in the body. The physiological or primary effects of static electricity are confined to the skin. The therapeutic effects are secondary and follow in physiological sequence the action which has taken place in the skin. The part which the skin plays in the animal economy has been repeatedly emphasized, especially under the head of HYDRO-THERAPY.

Analogous to the atmospheric pressure which regulates the intra-vascular blood-pressure, the functional energy of nerve-tissue is regulated by the terrestrial magnetic field by which we are surrounded. Diminution of air-pressure causes dilatation of the vessels along the external and internal surface of the body. This accounts for the occurrence of hemorrhages, especially from the exposed mucosæ, when atmospheric pressure is decreased. When the potential of the positive magnetic energy is lessened, it diminishes the degree of active control which the nerves, the carriers of

life-energy, exercise over the several parts of the organism. Thus the muscular fibers in the blood-vessel walls are relaxed and the vessel itself dilates, the moment the magnetic or electrical tone of the vaso-motors is lessened. This occurs through the cutaneous nerves which are alone exposed to influences of a magnetic character. The skin-nerves receive the impetus, the vaso-motors show its physiological presence. This explanation is analogous to the physiological syllogism by which Winternitz explains the action of thermic stimuli. If the patient receives a negative spray, the positive potential of the region is lessened, nerve-tension decreases, the tissues relax and the arteries dilate. We look upon negative applications of static electricity as being stimulating in character because the arteries dilate and the amount of arterial blood increases. The more the positive potential of the body decreases, the more stimulating will be the effect of a negative static current. The stimulating effect will finally merge into an irritating action as seen by the redness and soreness of the skin which frequently follows negative local applications. If the potential of the body is increased, the electrical action will be restorative, tonic, sedative. If applied to the head, the positive current will cause cerebral anemia and somnolence; the negative current will stimulate, causing wakefulness and mental activity.

The skin is undoubtedly the scene of action of static currents. Through the skin the whole system is reached, a sedative or a stimulating effect being reflected through the sympathetic nervous system as well as by contiguity of tissue. Thus we may produce a distinctly physiological effect on the renal circulation by applying a wave-current to the small of the back in cases of chronic interstitial nephritis. That the static current is of the greatest value in disorders of the skin itself, goes without saying.

A characteristic effect of static electricity is its action on oxygen. Oxygen has an affinity for positive electricity. When a positive charge of static electricity passes through a

volume of oxygen, a disintegration of the gas and a rearrangement of atoms of oxygen take place. A new gas is formed which has negative affinity and is tri-atomic. It is called *ozone* and has a characteristic odor. The passage of a flash of lightning through the atmosphere likewise produces ozone (tri-atomic oxygen). Ozone has more powerful oxidizing properties than oxygen. When a positive static spray is administered to the skin, some of the oxygen in the tissues and in the cutaneous vessels is changed to ozone and circulates as such, giving to the body, but more especially to the exhaled air, the characteristic smell of ozone.

From what has been said concerning the physiological effects of static electricity, we are prepared to summarize the therapeutic indications of the several static currents as follows:

1. *Positive* static electricity is to be administered to counteract hyperemia, nervous irritability, pain due to congestion, exaggerated reflexes, and all conditions due to overstimulation. It is a gentle circulatory regulator, nervous sedative and analgesic.

2. *Negative* static electricity is to be administered to counteract sluggishness of the circulation, lack of nerve-response, pain due to venous stasis (ischemia), absent or retarded reflexes and all conditions requiring stimulation. It is a decided stimulant, excitant and even irritant.

The different methods of applying static electricity are partly a matter of preference on the part of the operator, partly suggested by the character of the case. For general treatments the insulation and the use of the head-breeze are the best modes of application. For local troubles the most useful methods are the direct and indirect spray, potential alternation and the Morton wave-current. The operator should endeavor to make a static treatment as agreeable and comfortable to the patient as possible. There should be no unnecessary sparking and shocking. Hats, combs and steel-corsets should be removed.

There is always a suggestive element in using static electricity. This is a fact which is too well established to be questioned. Let the operator direct the suggestive influence into the proper channel in the interests of the patient. Let the operator's efforts not be confined to this. He should look upon the suggestive effect as being incidental and secondary to a well-planned and well-adapted therapeutic method based on clearly defined diagnostic features of the case and on exact knowledge of the physiological indications and possibilities of static electricity.

Currents of High Frequency.

Next to galvanism the so-called high-frequency currents are the most interesting and promising agents along electrotherapeutic lines. Properly speaking, it is not in keeping with the present state of our knowledge to classify these agents under the head of electro-therapy except in a provisional sense. From a physical standpoint the classification is not open to objection. In a physiological sense, however, its correctness is not altogether well established. The currents of high frequency produce effects on the organism that have nothing in common with the physiological activities of galvanism, faradism or static electricity. The physiological effects of high frequency suggest the action of force-modalities that are properly included under the head of radiology. The mysterious rays of Roentgen and the ultra-violet rays of Finsen seem to bear a closer relationship to these currents of high frequency than do the forms of electricity heretofore discussed. It seems that we are at the border-line where electrical modalities merge into the force-manifestations of visible and invisible light-rays. It appears difficult to identify the currents of high frequency as electrical phenomena when we consider their remarkable conduct under given physiological conditions. On the other hand, they are so closely related to currents of high voltage or static machine currents that it seems illogical to separate them from force-modalities so closely related to them. It

is undoubtedly a fact that they are the link between electricity and light, borrowing from either some characteristic physical properties and promising, therefore, to occupy a therapeutic place some day to which neither electricity nor light can aspire.

The first form of a high-frequency current that received attention and study from a therapeutic point of view was the static induced current with which the name of Morton will always be associated. The physics of high frequency was elaborated by D'Arsonval and Tesla, principally by the former, to whom we are also indebted for much of our knowledge concerning the physiological aspect of the subject. It was he and his colleagues Apostoli and Oudin who did the pioneer work in this new and wonderful field.

The term "high frequency" is a relative one and refers to the excessively high speed of alternations of the current. The term "alternation" suggests the conduct of the electromotive force, the direction of which is varying or alternates. In conjunction with the medium through which the electrical force-manifestations occur, namely the *ether*, the alternations are coincident with movements of the electrified ethereal molecules. These movements are oscillatory in character. For this reason, the term "oscillation" as the physical characteristic of currents of high frequency is used synonymously with "alternation." Strictly speaking, the two terms are not synonymous. All force-manifestations depend on oscillatory movements of the ethereal molecules. The phenomena of non-alternating (direct) electrical currents are likewise oscillatory,—so are all evidences of force-modalities. The very character of an alternation suggests a complex process of ethereal movement, consisting of at least two oscillations of each molecule giving to each wave (undulation) a distinct progressive movement serially, and transverse movement molecularly. Thus the ether is traversed by impulses of varying intensity, frequency and direction. In this way many lines of force-direction and vibration are established which belong to

other force-modalities, or rather which are the physical characteristics of the latter. Thus under given favorable conditions the complex process of vibration set up by a current of a certain high frequency may present the vibratory character (speed, wave-length) of the X-rays and many other force-modalities belonging under the head of ultra-violet force-manifestations. The friction and collision of the individual rapidly moving molecules are again a fruitful source of force-production and account for the wonderful induction-phenomena which are characteristic of currents of high frequency. We are prepared to admit that the currents of high frequency represent a complex force-modality, or rather a variable combination of force-modalities. They are neither all light nor all electricity, but contain the potentialities of many varieties of visible and invisible light, of X-rays, of electricity and perhaps of other modalities, the knowledge of which is still hidden in the bosom of the future.

The therapeutic importance of high frequency is contained in the close relationship between currents of high frequency and the rays emanating from the ultra-violet field or fields of the spectrum. This relationship has been independently suggested by different observers. In 1902 the author became suspicious of this relationship when two of his assistants suffered from subacute conjunctivitis which they contracted from exposure to the Finsen-rays. Shortly afterwards an attendant developed a subacute conjunctivitis who had not been exposed to the ultra-violet radiations of the Finsen arc-lights. This attendant had worked with static and high-frequency electricity exclusively. The author was unable to account for the eye-affliction of the nurse, when it occurred to him that the light from the vacuum-electrodes might have produced it. There was no doubt about the other two cases being cases of ultra-violet conjunctivitis such as are frequently seen in persons who work by electric arc-light. In thinking over the etiology of the third eye-case, the possibility of chemical rays being

mixed with the high-frequency discharge suggested itself. The silicate-of-zinc test was resorted to. The silicate of zinc did not show the characteristic greenish fluorescence. The test was a dismal failure. Next sensitive photographic plates were resorted to, to ascertain the presence of chemical light. A number of these plates showed no effect after development, others did. One 5x7 plate was black after development. The results of these tests were suggestive enough, and were communicated to an authority in the East with a request for an opinion. His opinion was that the effect on the plates was due to rays of daylight which had not been excluded, that the experiments, while very interesting, were deficient in technique, and, therefore, valueless. He gave it as his opinion that there was no connection between high-frequency currents and chemical rays.

Since the experiments were made, that which was a casual suspicion at that time, has become the basis of the therapy of high-frequency currents. Observations leading to the establishment of this basis were independently made by many observers in all parts of the world as far back as 1900. The incongruity of the opinions was the outcome of the endless number of degrees of frequency which are included under the general head of "high" frequency. The frequency of the current determines the coincident oscillatory and undulatory phenomena. A current of a certain frequency may cause coincident ultra-violet undulations, while another current of a different frequency might produce no such incidental results. Yet both currents might belong under the general or rather under the generic head of high-frequency currents. This point was foreshadowed by Bloch, of Paris, who commented on the uncertain therapeutic character of high-frequency currents in the treatment of eczema, and attributed the variability of the therapeutic effect to the variability of the frequency of the current. He suggested that a better knowledge of the frequency of these currents would be essential for the establishment of therapeutic principles. He, of course, thought of high-frequency currents

as electrical agents pure and simple. He did not suspect that these currents might be classed as radiologic potencies.

The therapeutic effects of currents of high frequency are both electrical and radiologic. A current of *comparatively low frequency* (500,000 oscillations or less per second) produces percussion-effects analogous to static currents. The cutaneous nerves respond and are principally concerned in the physiological reaction which follows. The effect is in the nature of an over-stimulation which results in hyperemia and subsequent over-nutrition of the surface treated. If the application is continued the reaction will gradually become more violent, resulting in a dermatitis. Currents of this kind are produced by the high-frequency coil which is attached to the static machine. If the vacuum electrode is held at a slight distance from the skin, the sparks which pass between the skin and the glass resemble static sparks in their intensely irritating local action.

A *comparatively high frequency* (500,000 and 1,000,000 or more oscillations per second) does not produce electrical effects of such a well-marked character. The stream of sparks is supplanted by the effluve-effect. For this kind of work the Oudin resonator is well adapted. The physiological action on the skin is analogous to, and not infrequently identical with, that of concentrated actinic light, even to the extent of the characteristic erythema and pigmentation. It is these true currents of *high frequency* that contain in their manifestations the ultra-violet element. It is safe to say that the therapeutic uses of these currents are largely dependent upon the chemical rays which are contained in the latter.

The electro-motive force in both low- and high-frequency currents is very intense. Thus we obtain in all high-frequency applications the effects of high voltage, especially the disorganizing action on the oxygen in the tissues and in the red blood-corpuscles. Whether these currents penetrate into the interior of the body or whether their electrical and physiological activity is confined to the surface of the

body, is not altogether clear, although it seems probable that their penetrating power, if at all present, is analogous to that of the radiations from an excited X-ray tube. The muscular contractions which currents of high frequency are capable of causing are amply accounted for if we look upon them as being due to the activity of the sympathetic nerves and not due to any direct penetrating action of the electric energy. The presence of heat-rays in the radiations from a high-frequency generator is easily demonstrated.

In justice to the subject, it may be of interest to know what opinions have been advanced by individual observers concerning the physiological effects of currents of high frequency.

D'Arsonval considers the distinction between high and less high frequency of the greatest practical moment. He states that the sensory nerves can not be stimulated except within certain extremes of relative frequency. Below and above these extremes they will not respond. He says that cellular life is stimulated by high-frequency currents in the same sense in which an increase in the positive potential of the organism will stimulate vegetative function. Through the cellular elements metabolism is increased. The excretion of CO_2 is 50 p. c. more active, the output of urea is augmented, the excretion of uric acid diminished. Functions of the stomach and intestines become more active. D'Arsonval made his observations on patients who had been placed in his high-frequency cage.

Hoorweg thinks that the physiological action of high-frequency currents consists of resonance-effects within the organism. Apostoli demonstrated an increase in the quantity of the urine and urea and an increase in the oxyhemoglobin of the blood. Patients are able to stand more exertion. They digest better and sleep more soundly. Tripet found that high-frequency currents (general applications) caused the quantity of sugar in diabetic urine to be markedly diminished. Freund states that the quality of the blood is improved in every way and attributes this effect

to the ozone which is formed in the body and carried by the red blood-cells. In diseases of the blood and blood-making apparatus and in tuberculosis the high-frequency current is an agent of supreme value. The increase in the oxygen-appropriating power of the organism is well marked.

The effects of high-frequency currents on bacterial life have been studied by many observers. The consensus of opinion is that germs are killed and their toxins modified and rendered innocuous by high-frequency currents. The latter modify the poison of scorpions and serpents, and render it harmless. D'Arsonval succeeded in suspending the vitality of diphtheria-cultures by short exposures to high-frequency currents. Algæ and fungi are permanently devitalized by these currents. Certain animals, especially rodents and the smaller felines, are susceptible to high-frequency currents and are easily killed without any apparent pain or struggle.

Therapeutically the currents of high frequency represent the most valuable agent in the treatment of skin-diseases, excelling any and all agents in this particular department of clinical medicine. They are indicated in all cases of mal-nutrition of the skin, especially the dry form of eczema, in fact all disorders of the cuticle requiring stimulation of the circulation and of the functional activity of the skin. They render good service in cases of lupus erythematosus, psoriasis, tinea, acne, etc. The application is made by means of a vacuum-electrode. Reaction is in proportion to the distance between glass and skin.

In cases of general diseases in which the quantity and quality of the blood are below par, general applications by means of an auto-conduction cage, a condensation-couch or a diasolenic cylinder are indicated. This holds good with special significance in cases of consumption. In honor of the distinguished professor of physiology at the University of Paris, who did so much in the interest of scientific electro-therapy, especially along the lines of high-frequency

currents, this general application has been called "D'Arsonvalization."

The high-frequency currents are indicated in cases where metabolism, especially the excretion of waste through the kidneys, is at fault. Even locally these currents alter and improve tissue-change, which makes them particularly valuable in cases of rheumatism and neuralgia.

The greatest accomplishments in this promising and interesting department of clinical medicine are yet to come. As soon as the exact relationship of the ultra-violet radiations, the X-rays and the currents of high frequency has been identified, there will be unfolded unto our eyes a vista of untold clinical possibilities. More light to guide our faltering footsteps along the hidden paths that wind through this mysterious land of wonderful promises, is the consummation devoutly to be wished.

CHAPTER X.

X-RAY DIAGNOSIS.¹

(The Roentgen-tube.—The Fluoroscope.—The Principles and Practice of Radiography.)

THE success of radiographic as well as radio-therapeutic work hinges upon an accurate knowledge of, and skill in, the use of the vacuum-tube (X-ray tube, Crookes tube) by which the Roentgen rays are produced. Familiarity with the tube is the indispensable condition of successful X-ray work. Without a good and suitable tube it is impossible to do good work. The tube is by far the most important part of any X-ray equipment.

The Roentgen Tube.

The tubes which are generally used nowadays are variations of the same original type: a glass globe with a number of tubular projections communicating with its interior. The positive terminal (*anode*) is in the center of the globe and is represented by a platinum disc. The negative terminal (*cathode*) is a concave (cup-shaped) circular piece of aluminium, from which the so-called cathodal rays emanate and meet in a point on the anodal disc called the *anodal focus*. This point is plainly visible in tubes which have

¹The contents of the chapters on X-RAY DIAGNOSIS and X-RAY THERAPY have, in substance, been published by the author in the "Journal of Advanced Therapeutics," the "Journal of the Roentgen Society (London, England)," the "Archives of Physiological Therapy," the "Journal of Progressive Therapeutics," etc. The diagrams are original with the author.



The X-rays are produced on the outside of the tube and represent lines which, if they were continued toward the interior of the tube, would all meet in the anodal focus. The latter, then, is the true center of radiation. When a tube has been used a great deal, the glass in front of the anode gradually takes on a bluish hue. This is due to the deposit on the internal surface of the tube of fine particles of platinum and is always a sign of age. Owing to the fact that these particles of platinum have a tendency to absorb gas or air, an old tube is most likely to be a hard tube. All these points referring to the physics of the tube itself and the physical characteristics of the rays emanating from the tube will be fully discussed under special heads.

The spark-length of a tube is the length of the electric spark between the terminals of a static machine or a coil which, with the tube in the circuit, would cause the tube to functionate properly. The vacuum of the tube determines the required spark-length. Thus, if a tube of a certain vacuum is lighted up properly by electric energy capable of producing a five-inch spark, the tube is supposed to have a spark-length of five inches. The form of electricity which is capable of lighting up an X-ray tube is characterized by high voltage and low amperage. For this reason the static machine is available for X-ray work. Static electricity has but little volume but tremendous electro-motive force. In the X-ray coil the ordinary street-current is transformed into one of high voltage by the action of the so-called interrupter and by the induction which takes place in the secondary winding of the coil. The original type of the X-ray induction coil is the Ruhmkorff coil, the construction and physics of which are analogous to the faradic coil.

The relative usefulness of an X-ray tube consists in its degree of exhaustion (*vacuum*) and in its fitness to retain its vacuum for a reasonable length of time. The vacuum is changeable in all tubes. Even during one X-ray exposure the internal conditions of the tube gradually become different. The passage of the electric currents sets free mole-

cules of gas or air that have been absorbed by particles of platinum. The constant tendency of a tube to change its vacuum makes it desirable to have some means of controlling the vacuity of a tube. This is the object of the so-called *regulating device* or attachment for softening or hardening the tube. The regulating device contains two terminals (a glass peg with a platinum spiral for the positive side, a disc for the negative side). The negative ter-

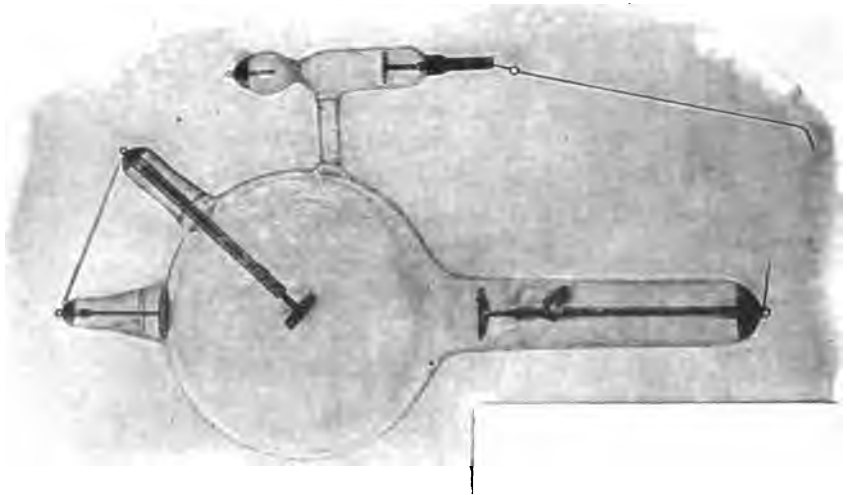

A WATER-COOLED X-RAY TUBE WITH REGULATING DEVICE.

minal of the regulating attachment is connected with a movable wire which can be brought near or in contact with the negative (cathodal) attachment of the tube itself, *i. e.* the hook or eye for attaching the negative cord to the tube. If the movable piece of wire on the negative side of the regulating attachment is brought close enough to the cathodal end of the tube itself to allow a spark to pass from the cathodal end of the tube to the wire, the spark will travel along the wire and be communicated to the disc

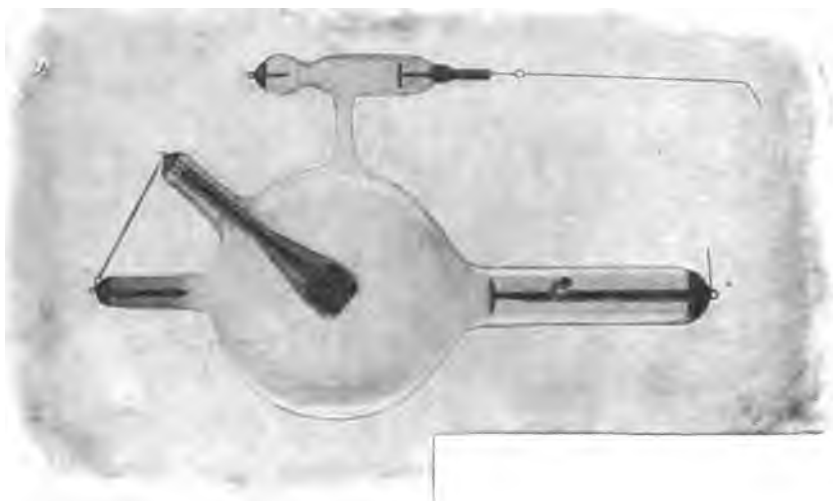

A HEAVY ANODE X-RAY TUBE WITH REGULATING DEVICE.

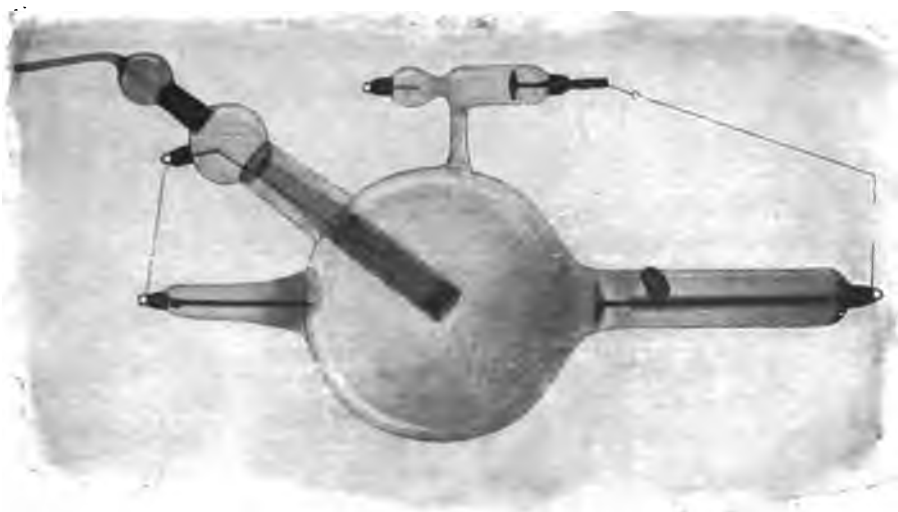

A GOOD STATIC X-RAY TUBE WITH REGULATING DEVICE.

which represents the negative terminal in the regulating attachment. The disc is made out of some chemical mixture which has the property of setting gas free when an electric current passes through it. The gas passes into the interior of the X-ray tube and *lowers* the vacuum, rendering the tube *softer*. If the movable piece of wire is turned up and the negative cord is attached directly to the eye in the wire (near the upper end of the wire) the softening effect would be correspondingly prompter and more intense, because all of the negative current would pass through the

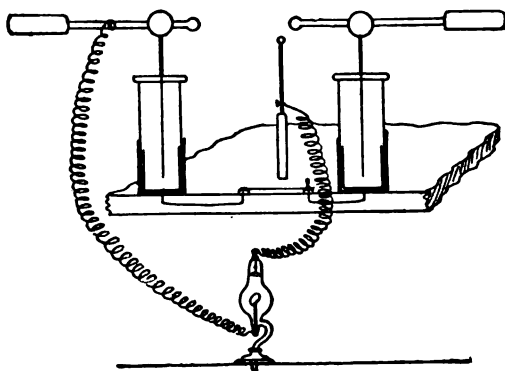

DIAGRAM ILLUSTRATING THE PRINCIPLE
OF THE SPARK-GAP.

chemical disc. If the negative cathodal cord is left undisturbed and, instead, the positive (anodal) cord is detached from the tube and attached to the positive end of the regulating device, the positive current would pass into the platinum spiral around the glass peg. The platinum spiral would eventually become hot and gradually absorb gas from the interior of the tube, thus rendering the vacuum *higher* and the tube itself *harder*. It is well to know that it takes a good deal longer to harden a tube than to soften it. If the tube, while in action, does not show the two hemispheres (green and dark) and is filled with a bluish light, it is too soft for the production of X-rays. In cases of this kind a spark-gap on the cathodal side will often make the tube

available (see diagram). If a stream of blue light or a spark passes between anode and cathode, the tube is worthless for X-ray work, because too much gas or air is present in the tube, indicating a puncture. The same may be said when the anode is surrounded by an areola of reddish light. The tube, under these conditions, must be re-exhausted. Tubes that have become too hard may be temporarily restored by prolonged rest or by slowly heating them in a dry-heat cylinder (oven).

These are the salient points in regard to all X-ray tubes. The geometrical, physical, chemical and physiological problems involved in the handling of the tube and in the application of its force-modalities, we will have occasion to consider at some length under the special heads of RADIOGRAPHY and RADIO-THERAPY.

The Roentgen rays, for purposes of diagnosis may be used in two ways,—(1) with the aid of the so-called fluoroscope, and (2) as a means of affecting a photographic sensitive plate upon which the shadows of an object are recorded.

Fluoroscopy.

The *fluoroscope* is a screen made of pasteboard upon which a layer of some chemical mixture is placed, which becomes fluorescent when acted upon by X-rays. The screen is usually incased in a quadrilateral pyramidal box, which is supplied with a handle, the screen representing the base of the pyramidal box, the apex of the pyramid being open. The fluoroscope is held by the hand of the operator, with the screen nearest the object. The most common fluorescent substances used in making fluoroscopes are calcium tungstate and barium cyanide.

The fluoroscope enables the operator to get a direct image of many parts of the body, the shadow-picture being projected on the screen. Fluoroscopy requires a softer tube than skiagraphy. Differentiation of the shadows of an object is more essential when the human retina receives the picture than when a sensitive plate is acted upon. Fluoro-

scopy should be practiced in a dark room, and not until the eyes of the operator have become habituated to the absence of day- or artificial light (ten to fifteen minutes). The less the eye of the operator is irritated by actinic light the greater will be its discriminating power in regard to the shadows of an X-ray image thrown on a fluoroscopic screen. In order to prolong the life of a fluoroscope as much as possible, the instrument should be kept in a dry dark place and protected against dust. The common size of a fluoroscope is 6x8 inches. For examinations of large parts (*e. g.* the chest) a fluoroscope of appropriate size should be employed.

In a general way it may be stated that the value of the fluoroscope has been and is very much overrated. Its usefulness is restricted to comparatively superficial parts (hand, wrist, elbow, thin shoulder, foot, small knee, child's hip, neck and chest). Examination of an adult's hip by means of a fluoroscope is never satisfactory. Fluoroscopic examinations of the abdomen of adults are impossible, the statements of optimistic radiographers notwithstanding. The operator should guard against the suggestive influences of his own imagination, lest he see things, not because they are actually there, but because he expects to see them and wants to see them. The operator who seriously stated that the diagnosis of gall-stones can be made by means of a fluoroscopic examination, and that he could make out the pancreas and other viscera, was certainly laboring under a powerful auto-suggestion. Even in superficial parts everything depends on the experienced eye of the operator. It may be safely said that the fluoroscope has a fourfold purpose and should be used accordingly:

1. To ascertain the presence of a foreign body;
2. To study a fracture or a dislocation;
3. To study parts which are necessarily movable (intra-thoracic contents) and, therefore, do not make good subjects for skiagraphic work;
4. To make an examination of a part which is to be skia-graphed. To explain:

It is understood that the fluoroscope can not be used on parts of the body that do not project distinctly differentiated shadows on the screen. If the tube is too low, the shadow of a hand would be a jet-black silhouette. Such a shadow picture would be worthless in locating a foreign body. If the tube is too hard, the shadows of the bones would be too faint and not distinct enough to show the details of a fracture. It is essential, therefore, to use the proper kind of a vacuum. If the part to be examined is too dense, *e. g.* the abdomen, it is useless to attempt fluoroscopy. The chest offers a fairly good field for fluoroscopic examination. The movements of the diaphragm and the heart, the size and position of the heart, the presence of mediastinal tumors, calcareous deposits and foreign bodies in the lungs can be seen and closely observed. The fluoroscope serves a splendid purpose in giving the operator a view of many parts of the body before he takes a skiagraph. Fluoroscopy should precede skiagraphy, whenever this is practicable. In the hands of an unskilled operator the fluoroscope has often proved to be productive of harm rather than good, because it offers a constant and strong temptation to permit imagination to take the place of judgment. The ideal way of making an X-ray diagnosis is to allow the rays to project the shadow-picture on a sensitive plate.

Radiography.

(N. B.—“Radiography” is the term generally employed by the profession. While it is etymologically objectionable, it is preferable to “skiagraphy,” which practically means the art of making shadow-pictures (“skia,” *shadow*), irrespective of the agent which is employed. Both terms cover the ground not only of X-ray photography, but include all radio-active substances and agents. In accordance with the scientific tendency of classifying physical phenomena in keeping with the causes which produce them, radiography seems to be the better term because it refers to the cause, while the term “skiagraphy” suggests the effect produced.)

There seems to be no doubt that the method of taking X-ray pictures is to a large extent the result of habit and

convenience and is, therefore, with most operators an entirely personal problem. It is true that there are certain vague notions of fundamental principles which serve as a ground work for skiagraphic procedures generally. In point of detail, however, and with reference to the conscious adaptation of radiographic work to specific anatomical problems, making the former subservient to the latter, the subject is far from being a uniform and logically developed *system* of scientific research. It represents a loosely connected series of *methods* and amounts to just as much as the diagnostic judgment, skiagraphic skill and reasoning power of the individual operator will allow. It seems to me that the topographic landmarks of this most fascinating and ever-important subject are clearly enough marked to admit of the recognition of more than the hitherto accepted vague and ill-defined outlines.

What is meant by a *good* X-ray picture? A striking *photographic* result appeals to the average physician because it possesses the elements of beauty which we are in the habit of admiring in pictures generally. The thoughtful radiographer, especially if he happens to be a good surgical anatomist, not infrequently remains indifferent at the sight of what others rave over, and often becomes interested when others see nothing of any consequence in a skiagraph. Why should this be so? The reason becomes apparent when we consider that the discriminating power of the eye of the layman is exercised in the differentiation of lights and shadows and the relation of these to each other. The eye is not accustomed to any other kind of reasoning. It can appreciate the lights and shadows of the real object and can, therefore, see the features and details of a photograph of the real object. A skiagraph is not the photographic reproduction of a real object. The innumerable waves of energy that emanate from the surface of the X-ray tube and, after traversing space and penetrating the object, strike every point of the exposed sensitive plate, leave a sum-total of impressions behind which are a truthful record of the density

of the object at every point. A photograph is a record of impressions made by rays of light of various degrees of intensity from the object. There is no suggestion of density or interception, partial or complete, of light rays.

This, however, is exactly what the X-ray picture presents. There are no light-rays coming from the object. The rays go *through* the object, each wave encountering a certain resistance determined by the density of the tissues traversed by that particular wave. The greater the degree of density, the more marked will be the interception of the quantity of force represented by that wave. When it finally reaches the sensitive plate, it leaves at one point a record of relative density of the tissues traversed. The sum-total of these density records is a skiagraph. The latter is not a picture of a real object, but the pictorial record of a physical characteristic of the object. The skiagraph, therefore, is not a representation *of* an object, rather an abstraction *from* an object. To give this abstraction a physical reality requires the application of a radiographically trained eye and mind. The failure to grasp the fundamental difference between a *photo*-graph (light-picture) and a *skia*-graph (shadow-picture) explains many errors of judgment on the part of not a few X-ray operators.

Radiographic Technique.

The process of taking an X-ray picture consists of the proper use of five different elements in their proper relation to each other :

1. The machine generating the form of electric energy which is available for the production of the Roentgen-rays. The static machine and the coil are the generators usually employed for this purpose.

2. The X-ray tube through which the high-tension current supplied by the generator is transformed into X-ray energy. The transformation is consequent upon (1) the concentration of the cathodal stream in a point upon the anode known as the anodal focus; (2) the radiation of

electric energy from the anodal focus through the hemisphere in front of the anode; and (3) the impingement of electrified molecules of ether upon the inner surface of the tube. The form of energy which is generated by induction on the outside of the tube is known as X-rays.

3. A device by which other forms of radiating energy can be intercepted and thus kept from mixing with the diverging X-rays. The researches of Freund, Walter, Tesla, Stenbeck and Schiff have demonstrated the existence of different forms of radiating energy emanating from the outer surface of the X-ray tube and capable of affecting a sensitive photographic film after penetrating an object, thus leaving a shadow wherever they have struck the film. What enormous importance this fact has in the production of a photographic result we shall see later on.

4. The object to be skiagraphed represents a mixture of substances of various degrees of density. The denser the substance, the harder it is to penetrate it by the Roentgen-rays and the fainter will be the shadow on the film after the latter has been developed in the dark room. Then, again, the position of the object has everything to do with the production of a shadow-picture (skiagraph) on the film.

5. The photographic sensitive plate which is properly protected against the actinic rays of sunlight or artificial light by being wrapped in a black and in an orange-colored envelope.

The five points mentioned indicate the necessary technical equipment for the taking of an X-ray picture. The first and last (current-generator and photographic plate) may be practically left out of consideration because their readiness and relative fitness for radiographic work are taken for granted. No one can expect to do good radiographic work unless he has the tools to work with. The best and most reliable generator for X-ray work is a good, well-constructed coil (15 to 20 inch spark-gap, 5, 10 to 15 amp. capacity). A static machine is capable of doing fairly good work, especially if its efficiency is supported by a good,

well-adapted tube. Taking it for granted that the operator is supplied with a generator of suitable capacity and that he is using a good quality of photographic plate, the discussion of the technique of X-ray photography practically resolves itself into a detailed consideration of (1) the tube, as the real generating source of X-ray energy; (2) the mechanical device which is to intercept foreign and disturbing forms of radiating energy and known as the X-ray Camera; and, last but not least, the density and the position of the object.

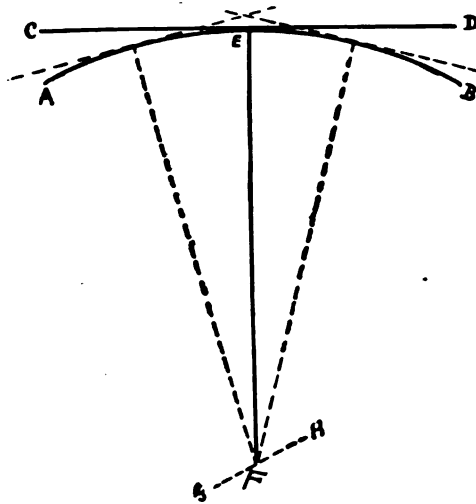

FIGURE I.

Geometrical Features of Lines of Radiation.—The lines or waves of electric energy arise or emanate from the cathodal surface and meet in a point on the anodal disc or plate. The concentration of cathodal waves in one point is made possible by the construction of the cathode. The latter is cup-shaped and represents a segment of a globe. The cathions (smallest particles of cathodal electric energy) arise from each point on the cathodal surface at a right angle to the tangent. In Fig. 1, A B represents the curve of the cathode. C D is a tangent touching the curve at E.

A wave of cathodal energy arises at E at a right angle to C D. F is a point on the anodal disc in which all cathodal waves meet. The dotted lines represent two more waves and the tangents of the points of issue. F is known as the anodal focus which does not necessarily represent the center of the anode (G H). From the anodal focus (F), where the cathodal rays meet and are united with the anions (smallest particles of anodal electric energy), radiation of

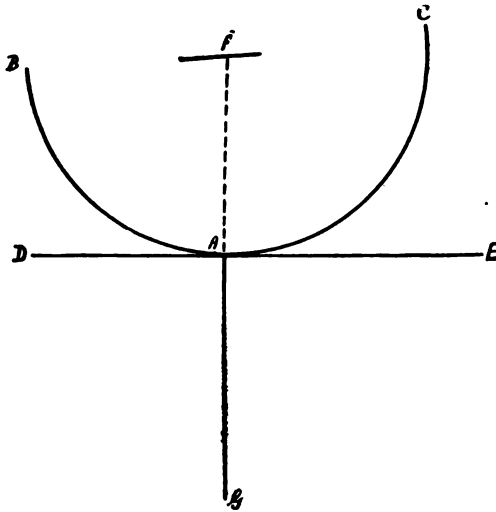

FIGURE 2.

force-waves takes place in all directions in front of the anodal disc. Thus the tube when lighted up shows the hemisphere in front of the plane of the anode aglow with a characteristic greenish light, while the hemisphere back of the anodal plane remains dark. When the radiation from the anodal focus takes place, causing electrified molecules of ether to impinge upon the inner surface of the tube, the outer surface of the latter gives rise to peculiar phenomena of force-production. Different kinds of waves of ray-energy arise from this outer surface, among them the waves

of that mysterious force discovered by Roentgen and called by him the unknown-quantity-rays or the X-rays.

The X-rays arise on the outer surface of the tube at right angles to the tangents of their points of issue. In Fig. 2, B A C represents a segment of an X-ray tube. The wave of energy which arises at F (anodal focus) and impinges upon the inner surface of the tube at A, is, by induction, transformed into an X-ray (A G) which begins at A (outer sur-

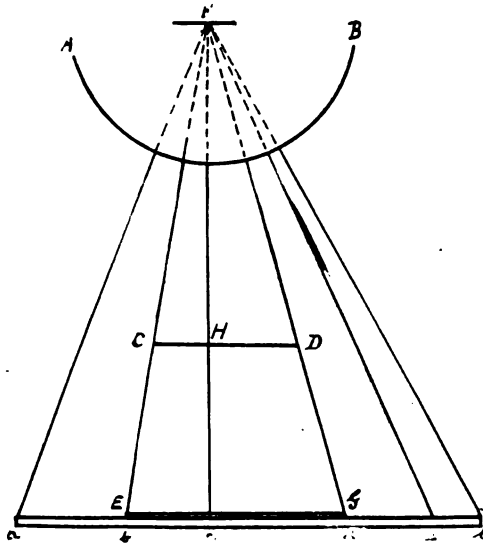

FIGURE 3.

face) and is practically a continuation of F A. D E is the tangent of the point of issue (A). For practical purposes we may look upon F as being the source of the X-rays and the center of the X-ray hemisphere. I shall refer to it in this way hereafter. In Fig. 3 the relation of the X-rays to a photographic plate is diagrammatically shown.

A B is the segment of an X-ray tube. Rays emanating from F strike a photographic plate (a f) which is lying on a table or some other solid support. It will be noticed that

the anode is parallel to the photographic plate. This is the ideal relation of the two. One ray emanates at right angles from F and strikes the plate at right angles (c), anode and plate being parallel. The rays which strike the plate at a or at b or at d or at e or at f increase in length the further they are removed from the median line (F-c). This median line is the shortest line because it strikes the plate at right angles. This line is of the greatest importance in X-ray

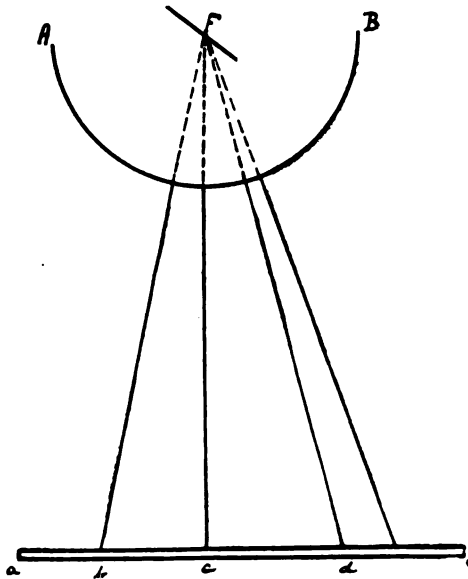

FIGURE 4.

photography. It is known as the anodal axis. Remember this definition once for all: *A line drawn from the anodal focus to the photographic plate at right angles to the latter, is known as the anodal axis, and is the shortest line between anodal focus and plate.*

The anodal disc and the photographic plate, however, do not necessarily have to be parallel. In Fig. 4 the anode and the photographic plate are not parallel. F-c is the anodal axis. It makes no difference how the X-ray tube is

placed; the photographic plate or, for that matter, the object placed above it, should be struck by the anodal axis in or near the center. If this rule is not followed, distortion of the shadow-picture is bound to occur. To illustrate this point, make the following simple experiment:

Take a book in your right hand and a lighted candle in the left. Hold the book six inches away from the wall and parallel to the latter. Hold the candle six inches away from the book in a line corresponding to the center of the book. The shadow of the book on the wall will be larger than the book. If you keep the book stationary and move the candle away from it, the shadow of the book will become smaller. If you move the candle toward the book, the shadow will enlarge. If you keep the candle stationary, but move the book toward or away from the wall, the shadow will become smaller or larger, as the case may be. As long as the book and the wall are parallel and the source of light remains in the median line, the shadow may be large or small, it will be a proportionate representation of the book. If you move the candle out of the median line or if you hold the book slanting toward the wall, a distorted shadow will be the result. The wall in this case represents the photographic plate, the candle-light is the anodal focus. The median line is the *anodal axis*. What principles does this simple illustration convey?

1. Avoid too large a shadow, *i. e.* put the object as close to the plate as possible;
2. The plane of the object should be parallel to the photographic plate;
3. The object should not be beyond the sphere of radio-activity of the excited tube;
4. The anodal axis should pass through the center or through the most important part of the object.

Fig. 3 exemplifies these principles. C D represents an object placed parallel to the photographic plate (a-f). The shadow of the object (E G) is larger than the object (C D). If C D were closer to the plate (a-f), its shadow would be

interposed object. This is because the softer the tube, the less penetrating are its X-rays. A thin part, like the hand, offers but little resistance to the waves of X-ray energy coming from the tube. For this reason, penetration is easily effected. Everybody is familiar with the skiagraphic or fluoroscopic picture of a hand. The greater density of the bony tissue makes the shadows of the phalanges darker than the shadows of the soft parts, which are less dense and, therefore, cast a lighter shadow. The point to be remembered is that it is not a question of thickness, but of density. It makes no difference whether we lessen the transverse diameter of a part by pressure and thus make the part thinner. Compression of a part diminishes the thickness, but does not change the density. The tissues are matted together, occupy less space, but are not rendered less dense. It is plain, therefore, that compression of an object, while it may lessen the distance between tube and object, does not change the density of the object. This is a point of some importance in connection with skiagraphic technique.

The vacuity of the tube suggests the law which underlies the adaptation of the excited X-ray tube to any skiagraph or therapeutic purpose, to wit:

"Hard tube, scant output, great penetration; soft tube, copious output, slight penetration."

The conclusions to be drawn from this well-established law are:

1. Use a relatively hard tube whenever a high degree of density is to be overcome. The harder the tube, the greater its penetrating power. The harder the tube, the longer the exposure of a deep part on account of the scant output of energy. The harder the tube, the slighter its therapeutic usefulness. The hard tube is the skiagraphic tube *par excellence*.

2. Use a relatively soft tube in skiagraphing thin parts which do not require much penetration. The softer the tube, the more intense its effect on superficial parts on account of the copious output of energy and comparatively

slight penetrating power. The softer the tube, the greater its therapeutic usefulness. The soft tube is the therapeutic tube *par excellence*. The proper therapeutic field of the X-rays is the skin and the subcutaneous tissues.

In gauging the thickness of a part, the question of density is of prime importance. Three inches of soft tissue are not by any means as hard to penetrate as three inches of bony tissue. In gauging the diameter of a portion of the body, it is principally the bulk of its bony structure which we are interested in.

The length of exposure depends on the thickness and density of the object and the degree of exhaustion of the tube. In recent times there has been much talk about instantaneous skiagraphy (X-ray snapshots). As far as my experience has taught me, instantaneous X-ray photography does not exist, except in the minds of overanxious coil-agents or visionary optimists. To be able to time and exposure properly, is largely a matter of experience. There are no iron-clad rules by which the operator can be safely guided. Experience, backed up by positive knowledge of the subject, is in this, as in many other lines, the *conditio sine qua non* of scientific and successful work. It is the wall that separates the amateur from the master, the mechanic from the scientist. Let the X-ray operator remember that short exposures (3-5 seconds) refer to skiagraphy of very thin parts, the tube used being moderately soft. The thicker and denser the part, the longer should be the exposure, the harder should be the tube. An exposure of three minutes to skiagraph the spine of a medium-sized adult by means of a tolerably hard tube, is not too long. I have made exposures of five minutes' duration with splendid results. Operators who use static machines will have to expose two and even three times as long as those who work with good-sized coils. On general principles I feel that it is better to over-expose than to under-expose a tolerably deep structure. Most failures in these cases are due to under-exposure. With a moderately soft tube the duration of an exposure should be :

For a medium-sized hand 10-20 seconds ;
 For a medium-sized wrist 15-25 seconds ;
 For a medium-sized elbow 20-30 seconds ;
 For a medium-sized shoulder 40-60 seconds ;
 For a medium-sized ankle, 20-40 seconds ;
 For a medium-sized knee 30-60 seconds.

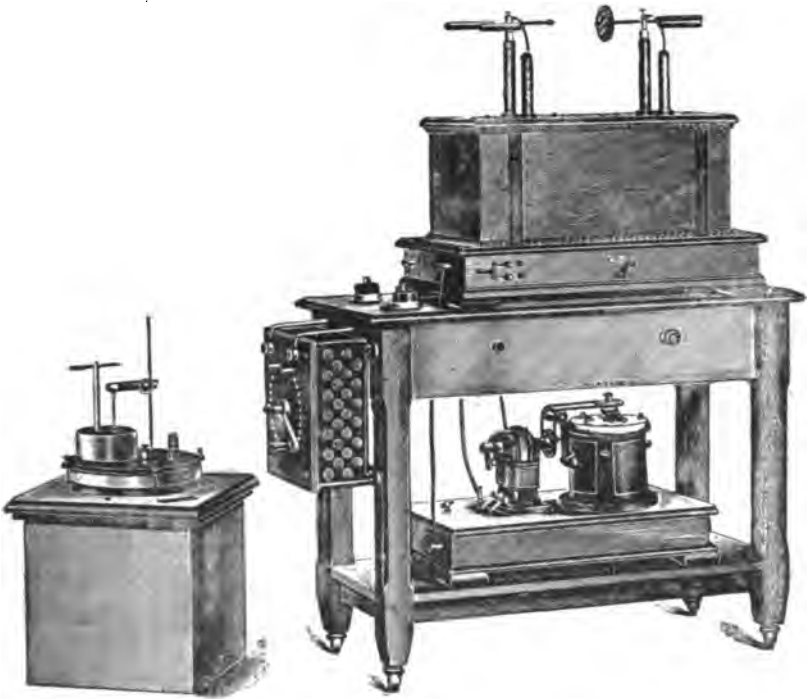

X-RAY COIL SHOWING INTERRUPTERS FOR DIRECT AND ALTERNATING CURRENT.

With a tolerably hard tube the duration of an exposure should be :

For a medium-sized hip 1-3 minutes ;

For the spine of an adult $2\frac{1}{2}$ -4 minutes.

Large coils with an immense output of current lessen the time of exposure. Much depends on the steadiness of

the tube. Some tubes do not hold out well, but become gradually softer while the exposure is being made. All these uncertainties affect the *modus operandi* in a given case. The only criterion to go by, therefore, is the personal equation of the operator. Theoretical skiagraphy is a myth. Experience alone gives it a place in the diagnostic armamentarium of modern medicine. *Vice versa*, experience is of little value unless it embraces the knowledge of the Why? and the Wherefore? It is theoretical knowledge that places upon experience the stamp of authority.

Tangential Radiations.—Reference has already been made to a peculiar form of radiation first described by Walter under the name of secondary radiations. There seems to be sufficient evidence to show that these radiations come directly from within the tube, and belong under the general head of ultra-violet rays. The radiations coming from the extreme red end of the spectrum are characterized by short waves and comparatively slow vibrations. As we approach the violet end, the waves increase in length and in rapidity of vibration. We also know that the angle of refraction becomes more acute as we leave the red and approach the violet field. Adding to this fact the positively known passage of true chemical rays from the inside of the tube through the glass, we have no hesitancy to identify those rays which have been described as Walter's secondary or tangential radiations. They are without a doubt these intratubular chemical (ultra-violet) rays refracted by the glass wall of the tube which acts like a prism. After being thus refracted they pursue a straight path, intersecting the diverging X-rays and penetrating any obstacle as far as their carrying power will permit, and possibly being again deflected from their path if they should meet with any obstacle capable of refracting and deflecting them. (See Fig. 5.)

In this way they may reach a sensitive plate, leaving a faint density-record upon it, which, of course, will not coincide with the X-ray shadow, but as a secondary shadow, not

sufficiently well marked to possess any individuality, but just enough to have a blurring effect. This blurring effect causes the X-ray outlines of a picture to appear less sharp and well-defined. As a result, we get flat X-ray shadows, without character, detail or perspective, whenever we attempt to make a direct exposure of an object to the X-ray tube. A device for the interception of the tangential rays

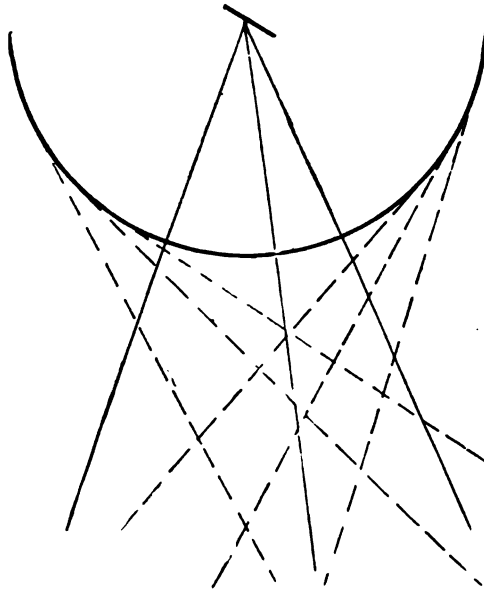

FIGURE 5.

has become a necessity without which skiagraphic work nowadays is practically impossible. In the light of modern radiologic observations it would not be preposterous to assume an active phosphorescent state of the tissues, produced by the diffused tangential radiations and the absorption of the X-rays by the blood (pigment of the red blood-cells). This phosphorescent state has been explained as being due to the absorption of the X-rays by the hemoglobin. That the X-rays do not represent the only force-modality given

off by the X-ray tube, is generally admitted. The sum-total of energy generated is composed of high-tension electricity (sparks, brush-discharges and a surplus of static electrical force which accumulates within the magnetic field of the tube), heat-rays, ozone, dynamic waves, induction-products and many other forms of force-manifestation mentioned by numerous authors (Freund, Schiff, Bang, Tesla, Kaposi, etc.).

In order to increase the beauty and usefulness of an X-ray picture, an attempt should be made to bring out details and lines with more precision. To prevent the phosphorescence of the tissues and to intercept the so-called tangential radiations is nowadays an important part of skiagraphic technique. The more successful we are in this, the clearer and better defined will be the outlines of the shadows even of faint and insignificant details. We must prevent the phosphorescence of the tissues produced by the indiscriminate diffusion of secondary radiations. To accomplish this purpose the German investigators, notably Albers-Schoenberg, use an adjustable lead-lined cylinder which is interposed between the tube and the object and allows a cone of X-ray energy to pass through it down to the object and sensitive plate. The tangential rays are held up by the cylinder and are thus prevented from scattering through the object. The Germans call this device a *Blende* (a "blind," device to keep side-lights out of horses' eyes). "Compression-diaphragm" is a bunglesome translation, because the device is neither a diaphragm nor does it compress. Since the "Blende" is analogous to the camera in photography which gathers in the desirable rays and shuts out side-rays, it seems to me that the term *X-ray Camera* is the best and most befitting appellation. A very useful device of this kind is on the American market under the name referred to.

The Interception of Secondary Radiations.—The X-ray camera, as the name indicates, is a chamber (camera) for the reception and transmission of X-rays and, we might add,

for the exclusion of other forms of radio-activity. It is an open cylinder which is interposed between the X-ray tube and the sensitive plate upon which the object rests. The cylinder is adjustable to any position, perpendicular, tilting, high or low. Its length can be regulated. By means of suitable diaphragms the cone of light passing through the cylinder can be reduced to any thickness. The X-ray tube can be placed in any desirable position above the cylinder. The mechanical adjustments for both cylinder and tube are simple and easily handled. The whole apparatus is mounted in such a way that it can be placed on any table and is always ready for work. Some prefer it to be suspended from the ceiling directly above the table. It can be immediately put out of the way when the patient is ready to leave the table. However, the question of choosing between a stationary or swinging type of camera is purely a matter of taste. Fig 8 is a diagrammatic representation of the X-ray Camera.

Figures 6 and 7 show the *modus operandi* of the camera. C H I G is the cylinder, C D E G representing the transverse section of a diaphragm placed inside. The lines from F represent the X-rays, the broken lines coming from the surface of the tube being the tangential or secondary rays. The X-rays pass through the cylinder (C H I G), through the object (K L) to the plate (M N). The tangential rays are stopped by the diaphragm (C D and E. G.) and by the cylinder. In both figures one tangential ray is seen passing through the object to the plate. This indicates the necessity of being able to elongate the cylinder and to adjust different sizes of diaphragms.

In order to understand the disturbing rôle which the tangential rays play, it is only necessary to think of the illustration previously referred to. Let us imagine the book six inches away from and parallel to the wall. The candle-light in the median line represents the X-rays coming from the anodal focus. Let us hold a smaller light near the candle-light. The result will be the production of a second

but much fainter shadow of the book on the wall. The additional light represents the tangential energy coming from the surface of the tube or Walter's "secondary radiations." These tangential rays are responsible for the poor results which follow free exposures without any attempt to inter-

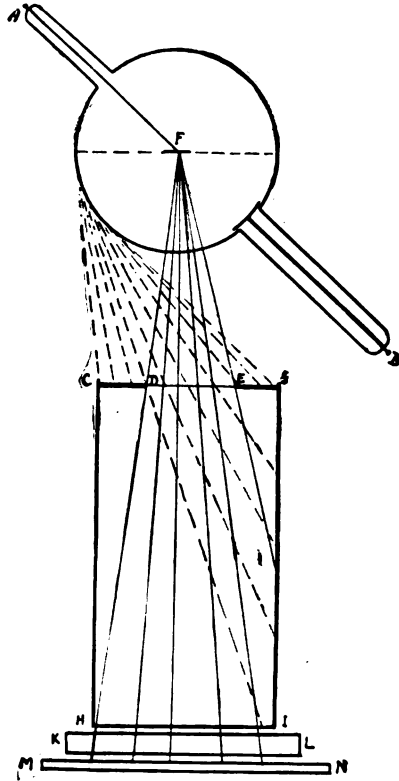

FIGURE 6.

cept or eliminate these disturbing rays. The pictures are flat and ill-defined, without character, expression and perspective.

The ideal position for the cylinder is at right angles to the plate so that the anodal axis and the axis of the cylinder

(line through the center) will coincide. In this ideal position a cone of X-ray radiance will fall through the object upon the plate, the base of the cone being the exposed part of the plate, the apex being the anodal focus. The transverse diameters of the cone will depend on the size of the opening

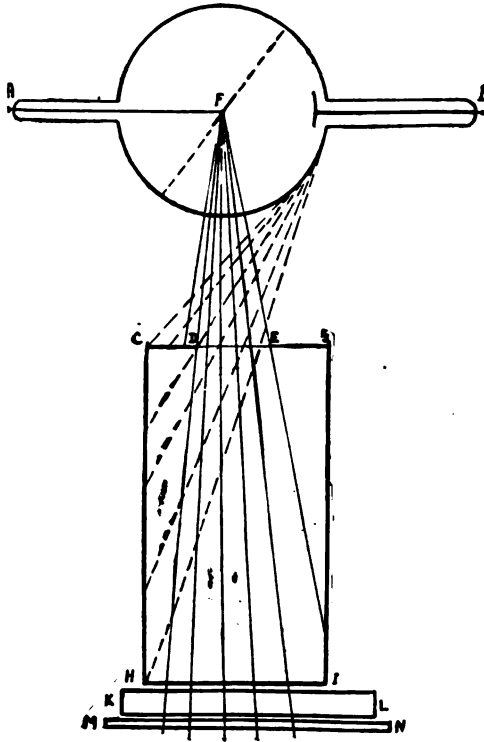

FIGURE 7.

in the diaphragm and the length of the cylinder. To put the cylinder in this ideal position, place the anodal focus directly over the axis of the cylinder, the latter being at right angles to the plate. The anodal disc may be parallel to the sensitive plate or may not. The parallel position is the ideal position. The essential point is that the anodal

focus be in the longitudinal axis (central line) of the cylinder. The position of the anodal *disc* with reference to the cylinder is theoretically immaterial, practically dependent on certain conditions of convenience. If it is parallel to the sensitive plate which is lying horizontally on a solid base, such as a table, the adjustment of the whole arrangement from plate up to the tube is simple. The longitudinal axis of the cylinder strikes the anodal focus above and the center of the sensitive plate below. It is needless to say that it strikes the anodal plane and the sensitive plate at right angles, the two being parallel. Thus we get a cone of light, whose apex is the anodal focus, whose base is the circle of light corresponding to the shape of the lower end of the camera-cylinder from which the symmetrically diverging rays emerge. The principal part of the arrangement is that the anodal focus is strictly in line with the longitudinal axis of the cylinder. Hence it makes no material difference whether we place the anode parallel to the sensitive plate or not. Even if the anodal plane were not parallel to the plate, the anodal focus being in the median line (longitudinal axis), the cone of the light would remain the same. An entirely different effect would result if the anodal focus were not in the median line. The cone of the light would be distorted, the rays striking the plate at different angles. The anatomical peculiarities of certain regions of the body sometimes make it imperatively necessary to tilt the cylinder and allow the rays to strike the object and plate obliquely. What I have previously stated concerning slanting rays and resulting distortion of the shadow, should be remembered in taking the picture and in interpreting the skiagraphic result.

Let us illustrate these points by a pertinent example. We are about to take an X-ray picture of a bullet which is lodged somewhere in the lumbar spine. In placing the patient over the photographic plate, we would put him on his back in order to get the bullet, which in this case is the *object*, as close to the plate as possible. (If the bullet is

supposed to be near the abdominal wall, the patient would, of course, be put on his stomach.) The cylinder is placed over the abdomen directly over the supposed location of the foreign body. The X-ray tube of proper internal re-

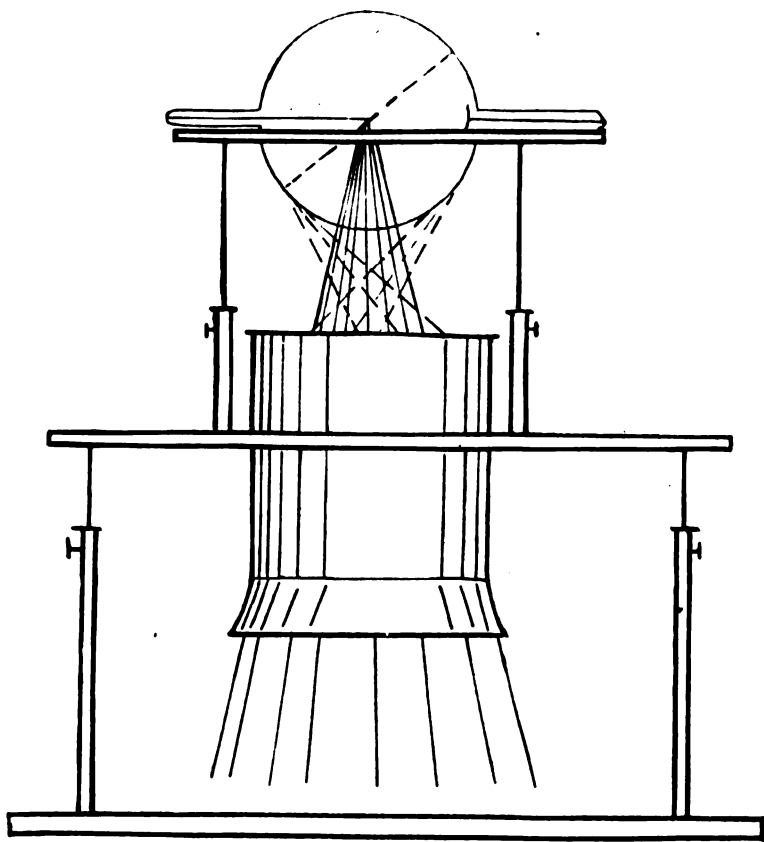

FIGURE 8.

sistance is in its proper position over the cylinder. The anodal axis passes from the anodal focus through the space intervening between the tube and the upper rim of the cylinder. It passes through the center of the cylinder, then

-

cal. The dotted lines represent the effect which is produced by the anodal focus being away from the median line of the cylinder, as a result the cone is distorted, which in skiagraphy is equivalent to an asymmetrical distortion of the shadows.

In order to immobilize the object to be skiagraphed it is not necessary to compress it because lessening of the bulk does not mean reduction of density. Compression is not only unnecessary, but in many instances decidedly undesirable. Aside from the discomfort which a patient is bound to suffer, a certain change of relative location or a malposition of the parts is liable to occur and thus a diagnostically worthless picture is apt to result. This is especially the case when we are dealing with a freely movable foreign body. Aside from the damage which is liable to be inflicted upon the surrounding tissues by sharp and pointed contour of a foreign body, compression of the part containing the foreign body is certain to change the relative position of the latter, the change of position being determined by the tendency of the foreign body to move in the direction of least resistance, *i. e.* away from hard or resisting tissue and in the direction of soft, non-resisting tissue.

I have demonstrated this point to my satisfaction before the class of the "Cincinnati Post-graduate School of Physiological Therapeutics" by skiagraphing a bullet which was imbedded in the fleshy part of the thigh. By using a so-called compression-diaphragm I was able to obtain six different X-ray pictures of the subject, no two pictures showing the foreign body in the same relative position. I could have added pictures of the same subject *ad libitum*, the degree and direction of the pressure determining the skiagraphic result. There is not the least doubt that compression is theoretically wrong and practically misleading to the surgeon and uncomfortable to the patient. The idea of compression was probably suggested by a misconception of the principle of immobilization, which in skiagraphy as well as in photography is a factor of prime importance.

Since snapshots are unknown in X-ray work, the objects we attempt to skiagraph must remain unmoved during the time of exposure. To aid in preventing change of position, we can immobilize almost every object in a simple, effective and painless manner. This is accomplished by mere contact with or very gentle pressure of the lower end of the cylinder which is interposed between tube and object for the purpose of eliminating various disturbing forms of ray-energy emanating from the X-ray tube and interfering with the X-rays proper.

PRACTICAL SUGGESTIONS.—Always remember—

1. That the object should be as close to the plate as possible, so that too large a shadow may be avoided;
2. That the planes of object and plate should be parallel;
3. That the object should be within the radio-active field of the tube;
4. That the anodal focus should, if possible, be directly over the center of the object;
5. That in placing an object beneath the cylinder of the camera for the purpose of skiagraphing it, no removable foreign substance, *e. g.* clothing, should intervene between the cylinder and the object or the object and the sensitive plate;
6. That, in order to protect the plate against heat and moisture it is sometimes permissible or even necessary to put one or more blotters or a layer of some water-proof non-opaque material between object and plate (*e. g.* in abdominal work on fat persons or if the exposures are long);
7. That the plate should not be brought into the room until everything is ready;
8. That a skiagraphic error is always due to some short-coming on the part of the operator either in placing the object, in making the exposure or in interpreting the result;
9. That the relatively good result will depend on the knowledge of the vacuity of the tube, on the adaptation of the tube-vacuum to the density of the object and on the proper timing of the exposure;

10. That a good home-made substitute for the camera consists in a piece of sheet-lead with a circular opening in the center, the lead being turned up two or three inches along the periphery of the opening (the object is skia-graphed through this opening, the lead being laid on the object);

11. That X-ray exposures, especially of deep parts, are frequently undertimed;

12. That it is incomparably easier to become a good X-ray photographer than it is to be a reliable X-ray diagnostician. It is simple to take a picture, but by no means so easy to interpret it.

The Photographic Part of the Work.

The exposure having been made, the plate is taken into the dark room, and there taken out of the two envelopes and put in the developing fluid. In order to do this portion of the work successfully it is necessary to understand the elements of photography and photographic technique.

The film which is on one side of the glass plate is called *sensitive* because it contains silver which is sensitive to the action of actinic rays. Corresponding to the relative intensity of these rays there is a chemical change in the silver. This change becomes apparent to the human eye the moment the plate is acted upon by a "developing" fluid. The film becomes transparent showing the discoloration in the silver. Some parts are strongly discolored, others less so, still others hardly discolored at all. Where no light has struck the film, no discoloration is seen, *i. e.* the film is absolutely transparent. It is the manifold degrees of discoloration of the silver that constitute the picture. Whenever an intense action of actinic rays has taken place, a correspondingly strong discoloration is seen, *i. e.* the impression left by the rays is black. Where only a faint action occurred, the discoloration is slight. Thus the lights and shadows of the object are reversed in the reproduction on an exposed plate. Photographers call such a picture a nega-

tive. The white face of a man is black in the negative, while his black coat is represented by a portion of the film which has hardly been acted upon by the light. If we take some sensitized paper and place the negative over it, what happens when the sun's rays are allowed to act upon the paper? The discolored portions of the negative offer some resistance to the rays and thus the paper is but slightly discolored by the rays. The transparent parts of the negative allow the rays to pass readily. The result is that the paper is quickly discolored. Thus the print on the paper reverses the conditions of the negative and, in doing so, shows the original lights and shadows of the object. The white face of the man is white in the print, while his coat is black. Such a picture is properly called a photograph because it represents a sum-total of *light*-impressions made on a sensitive plate or paper.

Strictly speaking, the word "X-ray photography" is a contradiction in terms. If we expose a sensitive plate to the action of X-rays, the latter will penetrate the envelopes which contain the plate and act upon the silver in the film just like sunlight. If the whole plate is thus exposed, the whole plate will turn black. If we place a silver dollar on the envelope containing the plate, the space covered by the coin will not be acted upon by the X-rays because they are intercepted by the metal. The negative will show the whole plate black except the part which was covered by the coin. If we place on the envelope containing the plate, a silver dollar, a piece of wood about the size and thickness of the coin and a piece of cloth having the shape and size of the coin, the negative would be black except in three places. The coin would intercept the rays completely, the wood slightly and the cloth hardly at all. Thus we would have no discoloration, a slight discoloration and a hardly perceptible discoloration corresponding to the places covered by the dollar, the piece of wood and the piece of cloth. If we place a square block of wood, one inch thick, on the envelope containing the plate and put the dollar on top of

the wood, the negative would show a square space of slight discoloration corresponding to the space occupied by the block of wood. The position of the coin would be marked by a circular space without any discoloration. Thus, the X-ray negative is a record of *shadows*, not of *lights*; a *skiagraph*, not a *photograph*. The depth or blackness of the shadow on the negative is in inverse ratio to the intercepting power of the object, *i. e.* the greater the intercepting power (opacity) of the object, the slighter the shadow, and *vice versa*. Thus, the X-ray negative of a hand shows deeper shadows of soft tissues than of bones.

The work of developing an exposed plate (making a negative out of it) is done in a properly equipped dark-room. It would be foreign to the purposes of this discussion to give technical directions concerning the equipment necessary for the technical part of this work and the *modus operandi* to be followed in doing the work. The X-ray operator who is ambitious and wishes to do his own developing, should take up amateur-photography and in this way acquire the necessary knowledge and skill for successful work in the dark room. He should use properly prepared plates of suitable size (5x7, 8x10, 11x14). The medium size is the most generally useful. For skiagraphs of the whole chest the 11x14 plates are the most available. It is difficult to overdevelop an X-ray plate. In common photography we are dealing with plates that have been superficially acted upon by actinic rays. In X-ray work the effect has penetrated down to the glass. For this reason X-ray plates should be developed slowly.

Let me formulate the *modus operandi* by way of a few simple rules:

1. Keep your hands clean;
2. Scrupulous cleanliness applied to the trays is indispensable;
3. Always use fresh and clean solutions;
4. The temperature of the solution should not be under 65° F. and not exceed 70° F.;

5. Do not think of developing any X-ray picture in less than ten minutes;

6. Negatives will not last unless they are carefully washed and every vestige of the fixing salt is removed.

There is no end to the developing agents that are recommended and used by different authors and operators. I have used two developers that are as good as, if not better than, any other developer used. The first was suggested by G. G. Burdick and is as follows:

(A.)

Ortol	15.
Metol	15.
Meta bisulphite of potassium.....	.75
Bromide of potassium.....	1.
Distilled water.....	1000.

(B.)

Distilled water.....	1000.
Sod. sulphite (c. p.).....	40.
Sod. carb. (c. p.).....	60.

Take 30 c. c. of each and dilute with from 30 to 120 c. c. of water, according to the effect desired. The less water, the more contrast; the more water, the more detail.

The second developer is recommended by Pizzigelli and is thoroughly reliable:

(A.)

Glycin	30.
Natr. Sulf.....	100.
Natr. Carb.....	20.
Distilled water.....	1000.

(B.)

Natr. Carb.....	100.
Distilled water.....	1000.

(Mix the two solutions and develop in the mixture.)

After developing the plate, the process of handling it (fixing, washing, drying) does not differ from that followed in ordinary photography.

To Interpret An X-ray Picture.

The diagnostic value of an X-ray picture is in proportion to the interpreting power of the operator. Thus a good X-ray picture may possess incalculable diagnostic value, or it may be valueless. To be able to interpret is the crowning effort and the most essential part of radiographic work.

Diagnostic X-ray pictures are taken for the purpose of determining 1. Change in normal structure (disease of bone); 2. A change in the relation of normal parts (*e. g.* fractures, dislocations); 3. The presence and location of an abnormal structure (*e. g.* a tumor); 4. The presence of some physiological concretion (*e. g.* stone in the kidney); 5. The presence and location of a foreign substance or body (*e. g.* a bullet, a needle).

Examination of an X-ray picture always means examination of the negative in a proper light. The first and most essential requirement on the part of the operator is familiarity with the appearance of negatives of normal parts. By experimental radiographic work on the normal body he can educate his eyes and his judgment. He can develop his sense of proportion and relation and, above all, become familiar with the meaning of shadows and the many fine *nuances* of the latter.

We should not forget that *an X-ray picture is always true within the limits of the physical conditions which produced it.* The shape and relation of the shadows are always dependent on the relative position of the tube and the object to the plate. The relative faintness or depth of the shadows may be due to under-exposure, over-exposure, faulty vacuum of the tube, under-development or over-development. Inasmuch as these physical conditions are subject to never-ending variations, we can readily see how the X-ray picture depends on, and is true only within, the limits established by these physical conditions. Thus: an X-ray picture will not show a foreign body unless the latter is capable of casting a shadow. A greenstick fracture may not show in the picture if the bend during the exposure points

towards the plate or toward the tube and in this way projects no shadow of an actual angle in the continuity of the bone. An over-exposed plate may not show the existence of a line of fracture. The picture may not show the presence of a foreign body, even if the latter is as large as a set of artificial teeth. In Cleveland, Ohio, a man was subjected to an œsophagotomy because the X-ray operator stated positively that the teeth were lodged in the œsophagus. The man died and the teeth were found under his bed. In another large town in Ohio a man who was supposed to have swallowed a set of teeth, was told that he was mistaken. Repeated X-ray examinations showed no teeth. The man went to New York, had the teeth located in his œsophagus by X-rays, was operated upon and recovered. The two instances show plainly enough that the success of X-ray work depends on the knowledge and skill of the operator. The X-rays never fail, never err, never bungle. The so-called X-ray mistakes are always due to incompetency of an amateurish operator.

The X-ray picture *per se* is always—*cæteris paribus*—a true picture. Its interpretation, however, is influenced by variable conditions. From the very nature of things, therefore, the X-ray picture is hardly ever more than one of the aids to diagnosis. Its province is to corroborate, to confirm, to add the testimony of an eye-witness to circumstantial evidence. There should be a history of the case under consideration, there should be a chain of symptomatic evidence to prepare for the reasoning involved in the interpretation of the skiagraph. As a link in the chain of diagnostic reasoning the skiagraph is invaluable, especially in the practice of surgery (fractures, dislocations, removal of foreign bodies). If the diagnosis involves questions of grave import, repeated skiagraphic examinations should be made.

In locating a foreign body the part containing the foreign body should be skiagraphed in the line of its perpendicular as well as its horizontal diameter. A skiagraph of

the knee, taken from above downward, the posterior surface resting on the sensitive plate, may show a bullet. Diagnostically and surgically this picture is valueless because it reveals nothing concerning the depth at which the foreign body is located. A picture from the side is necessary to enable the surgeon to make a diagnosis and operate accordingly.

In order to read a skiagraph intelligently, it is necessary to be familiar with the peculiarities of X-ray pictures. For example:

Skiagraph an elbow after putting the dorsal side of the joint on the sensitive plate. The uninitiated will diagnose a transverse fracture of the olecranon. The space between the humerus and ulna makes the bony tissue of the olecranon behind it appear so faint that the line of faint-shadow corresponding to the space between the bones looks strikingly like a line of fracture. Another example is the shoulder-joint. The space between the end of the clavicle and the acromion misleads the uninitiated in nearly every instance. He invariably diagnoses a fracture of the clavicle. I know of one instance in which the diagnosis of kidney-stone was made. The "stone" was one of the spinous processes, the extremity of which happened to cast an unusually deep shadow. In children mistakes are often made by operators who forget that ossification is not complete, and that allowance must be made for this fact. Many examples of the whims and peculiarities of X-ray pictures could be cited.

Many mistakes in interpretation are made through the purely photographic features of a picture. I remember an instance in which the nude knee of a physician was skiagraphed for purposes of demonstration. The picture showed faint lines running irregularly around the joint. These lines looked for all the world like folds of garments. Yet every one knew that the knee had been exposed nude. No one seemed to be able to account for the appearance of these faint lines. The solution was simple. In immersing

the plate in the developing fluid the latter did not flow rapidly and evenly over the entire plate, but covered only a part of the plate causing a line to appear where the fluid had halted for a fraction of a second. Lack of cleanliness frequently leads to serious blunders.

The X-ray picture as a positive means of diagnosis should be furnished by a radiographer who is equally familiar with the technical part of X-ray exposures and with the technique of developing plates. Nothing has injured the cause of X-ray work more than the bulk of poor radiographic work which is done by unskilled and inexperienced amateur-radiographers.

Stereo-Skiagraphy.

Stereo-skiagraphy is the most recent and promises to be the most valuable achievement of radiography. Its object is to make pictures which have the distance, perspective and plasticity of the real object. It is analogous to stereoscopy. Its technique has been well described by M. K. Kassabian, of Philadelphia, who summarizes the subject as follows: The ordinary photographs and images look flat, while stereoscopic pictures which are made by two lenses, each being two and one-half to two and three-quarters inches from each other (corresponding to the distance between the two pupils of the eyes) will be impressed on the retina as one picture thus giving a perspective view. The technique of stereo-skiagraphy consists of taking two separate skiagraphs of the same part, on two different sensitive plates, without changing the position of the parts, but displacing the position of the Crookes tube two and one-half to two and three-quarters inches (6 cm.), corresponding to the distance of the pupils of the eyes.

In order to produce two negatives of equal density the degree of penetration of the rays should be as nearly alike as possible. There are no two tubes that have the same degree of vacuum, and the same tube changes its vacuum during exposure. The operator should judge the time of ex-

posure of the second plate from experience. A self-regulating tube is preferable in all cases. It is proper to give a little longer time for the second exposure than the first because the tube runs down a little and the penetration lessens. Short exposures are most desirable.

In order to have two negatives of equal density, the

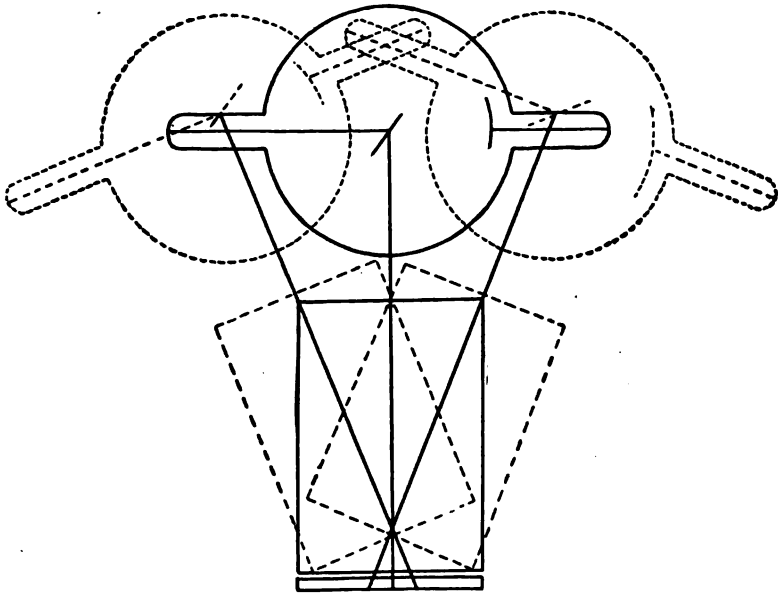

FIGURE 10.

DIAGRAM ILLUSTRATING THE PRINCIPLE OF STEREO-SKIAGRAPHY.

process of development should be carried on with great care. The developers should be the same for both according to the degree of density desired. Soft negatives are preferable.

The advantages of stereo-skiagraphy are obvious. In both long and short bones the trabeculæ are seen, and in the long bones we may see the arrangement of the lamellæ in the shafts and in the cancellous tissue. The spiral arrangement of the lamellæ is distinctly shown, especially in

the humerus and femur, as also is the change in their direction near the articular surfaces, bringing them into columns perpendicular to the surface of the pressure. In examining the dry skull, the grooves for the meningeal arteries are seen, the concave appearance of the skull processes, the frontal sinuses, the antra of Highmore, the turbinated bones, etc. It is very interesting to view these results in the living subject as well as in the skeleton. In studying the mechanism of the joints, these pictures give a perspective view of the relations of the articular surfaces of the bones and the actual depth, and the relation of the processes to the observer. Arteries, veins, bronchi, and excretory ducts, when injected with opaque materials, such as lead or mercury, show their exact relations (their depth) to the bones, the muscles, etc. Stereo-skiagraphy is, without a doubt, the most satisfactory method of locating foreign bodies. The same statement holds good in regard to fractures, the method procuring definite views of injuries, namely the exact location of the fragments, the amount of over-lapping, the separation, the degree of apposition in deformities, etc. The ordinary skiagraph does not show the variety and character of a dislocation. The stereo-skiagraph, however, overcomes this difficulty, producing a clear and definite view of the existing condition, so as to differentiate between an anterior and a posterior dislocation. In viewing the thorax we may see either an anterior or a posterior aspect, depending on the position of the plates. The heart, its position; the aorta, its relation to the vertebral column; the beautiful cage-appearance of the thorax, the location of a cavity or consolidation, etc., are interesting from a practical as well as from a scientific standpoint.

X-ray Accessories.

Walter's Skiameter.—In order to be able to determine the vacuity (hardness, softness) of a tube, most operators examine the shadows of their hand through a fluoroscope. This is a thoroughly bad habit on account of the too fre-

quent exposure of the hand to the rays. Dr. B. Walter, of Hamburg, has devised a little instrument which reveals the vacuity of the tube in a definite and reliable manner. The base of the instrument consists of eight small pieces of tin-foil of different thickness, which are covered with a bario-platinum screen. By holding the base of the instrument up to an excited X-ray tube, the bario-platinum will fluoresce in proportion to the amount of penetrating power which the rays possess. If the tube is soft, with but scant pene-

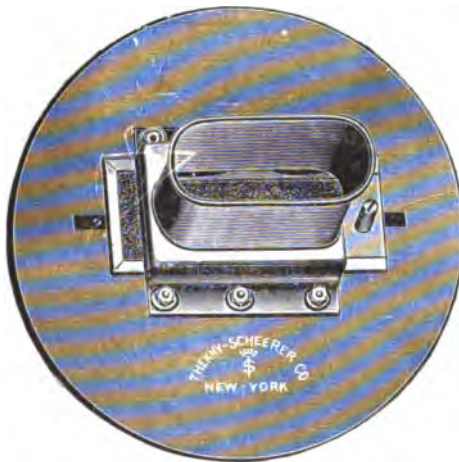

WALTER'S SKIAMETER.

trating power of the rays, there would be no visible fluorescence of the screen, except where it covers the thinnest piece of tin-foil. Over the remaining seven spaces the tin-foil would be too thick. The rays would be intercepted and no fluorescence visible. If the tube is a trifle harder, two spaces might be seen to fluoresce, or three or four, depending on the penetrating power of the rays and the corresponding thickness of the tin-foil. Thus a very hard tube would light up seven or even eight spaces. The instrument is called a skiameter and is indeed a very useful addition to an X-ray equipment.

The X-ray Table.—A solid wooden table, 6½x2 feet, answers the purpose. It ought to be fenestrated at two places, one fenestra to correspond to the location of a patient's chest, the other to his knees. The chest-fenestra should be eight inches square, the other one six inches square. The corresponding shutters should drop out, not lift out. When they are in position they should be secured from below so that there may be no unevenness on the surface of the table. They should be arranged so that they can be taken out altogether. Hinges are not desirable. The object of the fenestra is to enable the operator to make a fluoroscopic study of a part with the patient on the table and the tube secured below the table. The operator looks down at the part through the fluoroscope. The fenestra should be closed unless it is being used.

X-ray Tubes.—Every operator should have at least three or four good tubes. For radiographic work he should have a water-cooling or a heavy anode tube. For X-ray treatments any kind of a tube will answer. The static machine will meet the requirements of radio-therapy, but only in a limited sense those of radiographic work, the statements of some operators notwithstanding. A good-sized coil is indispensable if good radiographic work is to be done. Special therapeutic tubes (Caldwell's, etc.) are not of great practical value.

X-ray Stand.—It should be made of heavy wood and be solid. It should have a square, adjustable, lead-lined shield-attachment (18x12 inches). The tube is mounted about six inches above a perforation (four inch diameter) which represents the center of the shield. The latter, when in its proper position is approximately parallel to the table upon which the patient lies. Most X-ray treatments are best given with the patient on the table. By placing pieces of sheet-lead on the upper surface of the shield, the central opening can be given any size or shape to correspond to the surface to be treated. In treating the face, it is a good rule to cover the eyes separately. A shield can be made by

any carpenter and attached to any solid-X-ray stand. In radiographic work it may be used as a diaphragm to intercept tangential radiations.

Lead.—Lead is the cheapest and most useful metal to intercept the X-rays. The operator should keep a dozen or



X-RAY COIL AND CAMERA.

more pieces of sheet-lead on hand. One of the essential points of X-ray work is to cover sound parts carefully.

X-ray Camera.—Every operator should provide himself with some device to intercept tangential radiations. Even if he does not wish to invest in one or other of the

more or less expensive devices which are on the market, he can improvise an apparatus of this kind in a primitive and yet effective manner. Suggestions as to the manner of doing it have been given previously. The X-ray shield described above may be used for this purpose to good advantage.

Dangers of X-ray Work.

X-ray Dermatitis, etc.—The occurrence of any degree of an X-ray "burn" in a patient (molecular destruction of



CARL BECK'S TUBULAR DIAPHRAGM.

sound tissue) is almost invariably due to faulty technique. The proper use of sheet-lead and a reasonable amount of knowledge of the Roentgen tube should prevent it under all circumstances. The cases of X-ray idiosyncrasy (unusual susceptibility to X-rays) are very rare. The subject of X-ray "burns" is considered more at length under the head of "RADIO-THERAPY." Local reaction should never pass beyond the point of pigmentation.

In looking after the comfort and safety of his patient, the operator should not forget that his own body is liable

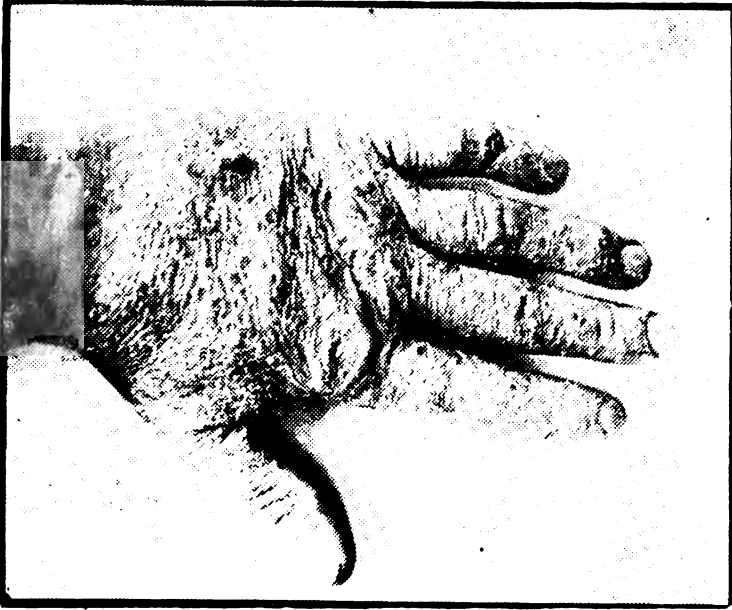

DIFFERENT DEGREES OF X-RAY DERMATITIS.

to be injured by constant exposure to the X-rays. He should avoid unnecessary exposure and should protect his body as effectively as is possible, while he is compelled to expose himself. Recently a complete line of very serviceable opaque gloves, aprons, shields, masks, etc., has been placed on the market. A very simple and effective plan is to put a substantial stationary screen in one corner of the room. The screen should be lead-lined and can be suitably covered or draped. A mirror can be placed behind the screen, enabling the operator to watch the patient and the details of the treatment through the mirror.

Among the disastrous results which may follow continued exposure to the Roentgen rays are:

Chronic inflammation of the skin, attended with great pain and intolerable itching;

Sloughing (gangrene) of the skin and subcutaneous tissues. This condition is not infrequently progressive, gradually involving more and more of the healthy tissue. In some cases it has led to complete destruction of the soft parts, necessitating amputation of one or more fingers of the hands and even of both arms;

Loss of hair (eyebrows, scalp) and deformity or total loss of nails;

A red, glossy appearance of the skin on both hands;

A wrinkled and shriveled appearance of the hands;

More or less acute or chronic conjunctivitis, sometimes followed by granulated lids;

Impairment of sight;

A tendency towards malformations and growths on the exposed parts;

Pruritus of the exposed portions of the skin;

A peculiar form of urticaria on the back of the hand which is badly aggravated by heat, actinic rays and gastric influences;

A general systemic depression characterized by a waxy skin, dull expression of the eyes, sunken features, impairment of the sweat function, mental hebetude, melancholia,

DIFFERENT DEGREES OF X-RAY DERMATITIS.





Digitized by Google

or two ago. Fortunately no one was injured. It seems that tube-explosions are due to changes in the temperature causing contraction or expansion of the glass.

Explosion of an X-ray Coil.—On February 22, 1904, 9 A. M., I was about to treat a case of epithelioma of the lip.



SKIAGRAPH OF HAND PROTECTED
BY AN X-RAY GLOVE.

The patient and the tube were in position. The moment the current was turned on, the top of the Scheidel coil which I was using was blown out with great force amid clouds of smoke and a deafening noise. The explosion caused a great deal of damage in the room, although the patient and myself escaped without injury. I have no com-

ment to make beyond demonstrating the possibility of an occurrence of this kind.

In conclusion let me add a word or two of advice to those who make a specialty of radiographic work. If they wish to remain true to the interests of the profession and to the interests of radiographic work, it is a good idea to be guided by three distinct and immutable rules of action, to wit:

1. Never do radiographic work unless it is to benefit some physician and through him some unfortunate patient. If a layman wants radiographic work done, he should be your or some other physician's *patient*, and the request come from the physician. If a patient asks for radiographic work without his physician's knowledge and consent, be careful. If the request comes from a lawyer, be doubly careful.

2. Give one or two copies of the X-ray picture to the physician for whom the X-ray work was done. If the patient is to get a picture, let his physician give it to him. Your dealings are with the doctor, never with the patient. Never give up a negative to any person at any time or under any circumstances.

3. Never pretend to interpret an X-ray picture to any patient. If the doctor asks for your opinion, give it. At all times remember that the X-ray expert should not be expected to give an expert surgical opinion unless he is called upon to do so. In this case he ought to get an additional fee.

By acting upon the suggestions given, the X-ray operator will be loyal to his colleagues, will be legitimate in his radiographic work, and—last but not least—he will keep out of much unnecessary trouble.

CHAPTER XI.

THE PRINCIPLES AND PRACTICE OF X-RAY THERAPY.

THE average physician looks upon the therapeutic use of the Roentgen rays as an interesting experiment which at one time promised a great deal, but has accomplished comparatively little. That this "experiment" possesses positive therapeutic value with well-defined clinical indications is denied by the bulk of the profession, while even radio-therapeutists of experience hesitate to make an unconditional statement of this kind on behalf of the mysterious X-ray. And yet the Roentgen rays as a therapeutic agent do occupy an established position. The disappointments which have followed in the wake of X-ray therapeutic work are attributable to one factor: misuse of a valuable therapeutic agent in the hands of misinformed or unskilled operators. The popularization of the static machine has placed the Roentgen rays in the hands of every physician who cares to invest in a machine. His equipment includes an X-ray tube. He is told how to attach the tube properly and then proceeds to bungle along, treating one case after another without diagnostic consideration for his case and utterly disregarding the physical conditions of his tube. Thus he adds to the bulk of X-ray work which is done throughout the country. After his first optimistic ardor has cooled off he neglects the work and joins the vast army of the skeptics who smile at the claims which are made on behalf of radio-therapeutic work. Adding to the skepticism of the bulk of the profession the untold injury which yellow journalism has inflicted upon this modern branch of thera-

peutic work, we can readily understand the unjust position of X-ray therapy and the reasons therefor. Yet, it is an undeniable and easily demonstrated fact that the X-ray is an established therapeutic agent, with a clearly defined sphere of usefulness. It is not a panacea nor is it a specific. Like all other therapeutic agents in medicine and surgery it meets certain conditions within certain limitations. The personal equation of the patient's physical make-up is always a factor which can not be defined with accurate precision. It is always the unknown quantity in any therapeutic-problem makes the concrete application of any therapeutic agent an *art*, however scientific the abstract physiological activity of the given therapeutic agent may be. In this sense X-ray therapy is on precisely the same level with the bulk of therapeutic agents at our command. The success of X-ray therapeutic work depends on an accurate knowledge of the physical phenomena which are included in the radio-activity of an excited X-ray tube. Without some knowledge of the physics of the X-ray tube the therapeutic use of the Roentgen rays is nothing but haphazard guess-work.

The Physics of an Excited X-ray Tube.

What happens when the converging beam of cathodal light is concentrated in the anodal focus and unites with the electro-positive element? The appearance of the illuminated X-ray tube is familiar. One hemisphere is aglow with a greenish light while the hemisphere behind the anodal (anti-cathodal) disc remains dark. These phenomena were known long before the time of Roentgen (Crookes, Geissler). Roentgen's discovery concerns a force-modality of some sort originating on the external surface of the excited tube. Roentgen could not account for the evidences of this mysterious radiating energy and designated them, therefore, as the unknown-quantity rays or X-rays. They are the product of an induction-process of some sort, or, to speak with more accuracy, it seems that the phenomena which

takes place in the excited tube induce a series of correlative force-manifestations outside of the tube. I say "correlative" because the X-ray phenomenon depends in all its physical characteristics on the ever-varying physical conditions which prevail in the interior of the tube. The term "X-ray," then, is rather a generic term covering an almost endless variety of manifestations and degrees of intensity of this mysterious induced force.

The most important physical element of the tube is the degree of exhaustion. Upon it depends the relative intensity of the phenomena induced on the outside of the tube. From the lowest degree of exhaustion to the highest vacuity compatible with the safety of the glass tube, there is a constantly changing activity on the outside of the tube. As the degree of exhaustion becomes higher, the X-ray-waves seem to travel with greater velocity and penetrating power. The wave-length diminishes in inverse ratio to the internal resistance of the tube, while the number of undulations, measured in units of space-dimension as well as of time, increases. As the internal resistance of the tube decreases, the wave-length of the force-manifestations on the outside of the tube increases, while the number of undulations per inch or per second is gradually diminished. In making these statements, we are reasoning from premises which are furnished by the vibratory theory of force-manifestation, now generally accepted by physicists, and by the experimental evidence adduced by careful observers.

The computation of the length and velocity of luminous vibrations of the different parts of the solar spectrum is not altogether a theoretical calculation. Wave-speed and wave-length, while they are results of abstraction and deduction, furnish the only plausible explanation of the various phenomena of light, light-transmission, and, in fact, of all manifestations to force by which matter proclaims its existence in nature. The X-rays, being one mode of energy, must have their undulations and their wave-length analogous to those of other forms of force-manifestation. When

the vacuum of the tube is too low for X-ray production, there is, nevertheless, an abundance of chemical light-energy. These radiations are located in the spectral field beyond the violet end and, therefore, classified as ultra-violet radiations. This is a distinctly generic designation, because it refers to perhaps thousands of different forms of radiation, whose wave-speed is greater and wave-length less than those of the rays in the violet field. The length of a ray from the violet field is approximately given as the 0.0000167 of an inch, while the number of undulations per second is about 727,000,000,000 (Eisenlohr, Silliman). The radiations from the ultra-violet field diminish in wave-length as they get further away from the (visible) violet field, while the vibrations increase in number. All these vibrations belong to the invisible chemical field of the spectrum.

That the force-manifestations which take place on the outside of an excited X-ray tube generically include an indefinite variety of force-modalities representing different speed and length of oscillation and undulation of ethereal molecules, is plain. That some of these modalities are characterized by relatively slow oscillation and comparatively long waves is proven by the presence of heat-rays, while, strangely enough, spectroscopic analysis of cathodal rays shows a scarcity of luminous rays, but an abundance of chemical rays. It seems justifiable, therefore, to consider the Roentgen rays a generic aggregation of force-modalities rather than one specific kind of radiation.

The question of refrangibility is of some importance in solving the problem of the physics of the X-rays. The least refrangible rays are the red. The refrangibility increases toward the violet end of the spectrum. It has been stated that a certain quantity of ultra-violet radiations comes from the inside of the X-ray tube and penetrates the glass. Considering their extreme refrangibility, it would not be difficult to imagine these radiations to be refracted by the curved surface of the tube, which in this case acts like a prism. This seems to offer a plausible explanation for the

tangential waves which Walter has described under the name of "secondary radiations." They are unquestionably refracted ultra-violet radiations from within the tube.

That the X-rays belong under the generic head of ultra-violet radiations is further shown by their action on sensitive photographic plates. They affect photographic plates like actinic rays. The greater penetrating power of the Roentgen rays is due to the speed and intensity of transmission. The ordinary chemical solar or electric arc-light does not affect the silver throughout the entire thickness of the film, but only the superficial layers of the film. The X-rays penetrate the film down to the glass. In this way the different manner in which a sensitive plate acts after an X-ray exposure, or after exposure to sunlight, is easily explained. It is almost impossible to over-develop an exposed X-ray plate, because the whole film down to the glass has been acted upon.

The intercepting power of glass is another feature which suggests the similarity of the two forms of radiation. Fin- sen discarded glass because of its absorptive action. He used rock-crystal in its place. It is peculiar that glass will cast a decidedly deeper shadow on the fluoroscopic screen than rock-crystal. The latter, if of good, pure quality, seems to offer absolutely no obstacle to the Roentgen rays.

The therapeutic effects seem to furnish the best evidence. The destructive action of the X-rays results in necrosis due to impairment of the trophic nerves, which causes an obliterative endarteritis. The so-called X-ray burn is distinctly a necrotic process. The same effect, on a smaller scale and more superficially, is noticed after forced application of concentrated actinic rays. Beginning with the primary erythema, the subsequent dermatitis and the resulting deposit of pigment, the effects of the two forms of radiation are certainly only different in degree of intensity and in depth of penetration. I have seen a typical dermatitis and superficial necrosis follow prolonged actinic exposures, the gross features and microscopic appearances

not differing in the least from analogous effects produced by the X-rays. The relative degree of germicidal action of the two forms of radiation is unquestionably an argument in support of the views expressed. The ultra-violet rays are distinctly germicidal; so are the radiations from a low tube. The higher the internal tension of the tube, the slighter is the effect on germ-life. This fact has established the therapeutic value of the soft tube and, at the same time, explains the futility of the therapeutic efforts made with the higher-tension tubes. No one thinks nowadays of X-ray therapy in connection with deep-seated lesions. The harder the tube, the more meager the amount of energy generated, the more rapid the penetration and diffusion. The softer the tube, the greater the output of energy, the more concentrated and powerful the effect. The softer the tube, the more striking is the resemblance between the action of the X-rays and the effect produced by concentrated chemical rays.

My object in dilating upon these physical characteristics of the X-rays is plain. I desire to demonstrate that they are true ultra-violet radiations, and thus find a solid scientific basis for the therapeutic indications of X-ray work. We are fairly well acquainted with the physical character and the physiological activity of actinic rays. Finsen's researches have given us much information concerning this subject. If the X-rays are generically ultra-violet radiations, we are no longer at sea in regard to their therapeutic possibilities. One additional point indicates the strong generic relationship between the two force-modalities. Finsen has shown that the deposit of pigment in the skin is Nature's way of protecting its organism against the destructive action of the actinic rays. Pigment absorbs these rays. Experience has taught me that the skin of the negro offers more resistance to the X-rays than non-pigmented cuticle. It is harder to get a good skiagraph of a negro's than of a white man's spine. The large surface exposed

(abdomen and back) contains so much pigment that a good deal of X-ray energy is lost, being absorbed by the pigment.

The pigment in the red blood-cells absorbs X-rays. Thus we can explain why it is comparatively easy to skiagraph a bloodless part (hand after an Esmarch bandage has been applied to the arm). Radiographers know that anemic persons make excellent subjects for radiographic work.

The practical conclusions from these theoretical premises may be summarized thus:

1. The X-ray and the actinic and ultra-violet rays of the solar spectrum belong under the same generic head;
2. The difference between the two force-modalities is the greater speed of oscillation and the shorter wavelength of the Roentgen ray;
3. The penetrating power of the X-rays is in direct proportion to the pressure of the vacuum in the tube;
4. Penetrating power and quantity of energy are in inverse ratio to each other;
5. Like all induced forms of energy the X-rays lose their volume in proportion to the distance from the source of induction, *i. e.* the tube;
6. The X-rays like all actinic rays are slightly intercepted by pigment in the skin and in the blood (hemoglobin);
7. The destruction wrought by the X-rays is due to disintegration of the pigment-carriers (skin and red blood-corpules);
8. The therapeutic action of the X-rays is confined to the place of greatest interception, *i. e.* the skin.

These eight points contain the principles of X-ray therapy. Translating the language of the theoretical physicist into the therapeutic directions which the X-ray operator needs in his practical therapeutic work, the eight points enumerated above could be formulated as follows:

1. Generically speaking, the active principle of X-ray therapy and of Finsen-light and sunlight is the same, *i. e.*

the germicidal, stimulating and destructive ultra-violet force-modality;

2. The ultra-violet ray of Finsen is closer to the violet field of the solar spectrum than the X-rays;

3. The harder the tube, the more penetrating the rays,—the softer the tube, the more superficial the effect;

4. The harder the tube, the less X-ray energy,—the softer the tube, the greater the amount of X-ray energy, making the soft tube the ideal therapeutic tube;

5. The closer the tube is to the skin of the patient, the more intense the effect;

6. The X-rays are partly taken up by the pigment in the skin and in the blood. The greater the amount of X-ray energy, the greater the amount absorbed;

7. The X-ray, after being partly absorbed by the skin-pigment and the hemoglobin, first produces a stimulating effect. Through the sympathetic (vaso-motor) nerves the stimulating effect is reflected and thus a stimulating and pain-relieving effect is obtained in distant or deep structures. If the application is continued, overstimulation takes place, resulting in irritation of the pigment-carriers (skin and blood-corpuscles). The skin reacts by a distinctly inflammatory process. The red corpuscles are disintegrated and the small arteries are occluded, causing local necrosis by lack of nutrition. If the part is composed of morbid tissue, the latter dies, leaving a comparatively healthy ulcer behind. The absorption of the X-rays by the red corpuscles explains the phosphorescence of the tissues which frequently interferes with the skiagraphic result. It also explains the appearance of an X-ray "burn" in parts that have not been directly exposed. If an X-ray treatment is not pushed to the extent of overstimulation, it may stimulate local nutrition and metabolism. This explains the absorption of growths after X-ray treatment.

8. X-ray therapy should be confined to superficial lesions. The cure is accomplished by disintegration and subsequent destruction of the pigment in the red blood-

corpuscles. Keeping in mind the physics of the X-rays and the physiology of their action on organic tissue, we can readily see that deep-seated lesions are inaccessible to the therapeutic action of the Roentgen rays. In addition to this, we know that the therapeutic effect is in proportion to the amount of X-ray energy. Since the latter is in inverse ratio to the penetrating power of the rays and since the deeper the lesion, the greater the penetration required, it stands to reason that energy is lost according as we increase the depth of penetration.

The Technique of X-ray Therapy.

The fundamental law of therapeutic X-ray work is suggested by the necessarily superficial character of the therapeutic effect produced by the Roentgen rays. The soft or low vacuum-tube produces an abundance of X-ray energy with but scant penetrative power. *The soft tube is, therefore, the therapeutic tube par excellence.* Gauged by Walter's skiameter it should light up three or four of the test-holes of the instrument. The standard for an exposure is ten inches distance between the tube and the surface to be treated. The duration of the standard treatment is three minutes, a treatment to be given every other day. This kind of a treatment (soft tube, distance ten inches, duration of treatment three minutes) would, under ordinary circumstances, produce a *stimulating* effect and result in more active granulation and absorption. It would be indicated in indolent ulcers, in various forms of skin-diseases due to malnutrition, in fact in all conditions which demand an increase in local metabolism. In most non-bacterial skin-diseases the results are not usually permanent because these diseases are but local expressions of systemic conditions. By lessening the distance between tube and skin, or by continuing the exposure for a longer time, or by repeating the treatment every day, the effect would be intensified. It would be like increasing the dose of a remedy. When the action of the rays gets beyond the stimulating point, the

germicial effect is best marked. Whether the latter is produced by the action of the ray on organisms of but little resisting power, or whether the germicial effect is coincident with the accumulation of oxygen in the part treated, is not quite clear. It has been demonstrated, however, both by laboratory-experiments and on the living subject, that pus-germs and the tubercle-bacillus soon are rendered inert and finally die if they are exposed to oxygen. We know that currents of high voltage and high frequency have an effect on the composition of the atmospheric air by their affinity for oxygen. How far this affinity will affect the oxygen in the body we are as yet not prepared to say. There is, however, no doubt about the germicial action which follows applications of the X-rays. If the X-ray dose is increased still more, we arrive at the point at which *destructive* effects are to be expected. A destructive treatment would be administered by a soft tube used every day for five to ten minutes at a distance of ten inches. This is the typical X-ray treatment for superficial cancer. It is understood, of course, that the stimulating, germicial or destructive effects do not follow one treatment, but represent the accumulative therapeutic effect of a series of treatments.

It would be folly to recognize iron-clad rules which must prevail under any and all circumstances in every case. The personal equation of the patient, as apparent to the individualizing judgment and to the experienced eye of the operator, is the unknown quantity which can not be forced into the tight-fitting limitations and indications of a stereotyped law. As long as every patient presents a personal equation of his own to be solved by the personal equation of the physician, every kind of therapy must necessarily contain an uncertain element which makes therapeutic practice an art rather than a science. The suggestions given are hypothetical. In applying them, the experience of the operator must adapt them to concrete conditions. This may mean shortening or lengthening the exposures, changing the distance of the tube from the skin, etc. It is under-

stood, however, that the tube must at all times receive its full capacity of current. The current should not overheat the anode before the time of exposure is over.

The surface to be treated and the anodal disc should be placed approximately parallel to each other. An imaginary line drawn through the center of either should be at right angles to the plane of the anode and to the plane of the surface to be treated. Thus, if the patient is lying on his back on a suitable table, the tube should be placed directly over the affected area. The anode should be parallel to the surface and should be directly over it. The glass of the tube should be ten inches from the area to be treated. This is

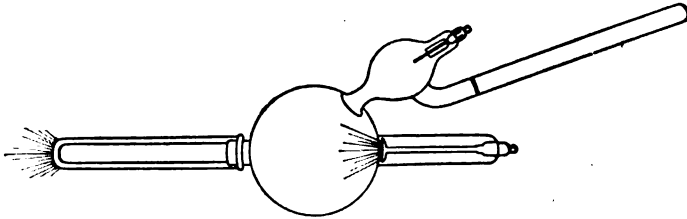

CALDWELL'S THERAPEUTIC TUBE.

the ideal position. Variations from this position are frequently necessary owing to the peculiar location of the trouble. The tube-stand should have a lead shield attached which has adjustable diaphragms in its center and is interposed between the tube and the patient. This tube-stand is not an absolute necessity, but a most desirable convenience. The perforation in the center of the diaphragm is placed directly over the area to be treated. Pieces of sheet-lead are put around the perforation so that only the area to be exposed remains uncovered. When no shield is used, the patient has to be covered carefully with sheet-lead (not lead-foil) so that the X-rays can not impinge upon any part except the area which is to be treated. If the hand or the arm of the patient is to be treated the patient can sit on a chair and place his hand or arm on a table. Otherwise it is

by all odds best to place the patient on a properly constructed table. The recumbent position is most convenient and comfortable for both patient and operator. Always be careful to cover every bit of skin that is not to be exposed to the X-rays. The lead-dressing is the most important part of the whole procedure because it limits the action of the rays and in this way prevents X-ray "burns." The latter are really not burns. They are evidences of reaction, and if they occur in the right place, have the highest therapeutic significance. Inasmuch as reaction is necessary, the cure in cases of morbid growths depends upon it. X-ray burns over large areas of healthy tissue are in the majority of instances due to faulty technique on the part of the operator. Exposures should be made in a darkened room so that the operator can watch the phosphorescence of the tube, should be noiseless in order not to frighten the patient, and should be painless. The tube should be properly attached to prevent sparking. The operator should not expose himself unnecessarily, especially his hands and eyes. The deleterious effects of the X-rays on the procreative faculty of operators have been emphasized by many observers. A tube which has become hard from constant use should be allowed to rest a week or longer and then softened. The employment of the regulating (softening or hardening) device on overworked tubes is not conducive to preserving the tubes.

Clinical Indications.

The triple action of the X-rays (stimulating, germicidal, destructive) should be remembered in adapting means to the end. The operator should have a clear pathological conception of his case before he can attempt to make X-ray exposures intelligently. The X-ray is at its best in conditions where morbid tissue is to be destroyed and where the lesion is extensive and involves the subcutaneous tissues. The following list of diseased conditions probably represents the present status of the question, as suggested by the study of over 500 cases which have been under observa-

tion during the past four years at the Cincinnati Post-graduate School of Physiological Therapeutics. The directions given should be modified to suit the individual case.

ACNE.—In the common form of acne the results are very good. Exposures every day or two for five minutes. Distance of moderately soft tube ten inches. Protect the eyes. In acne rosacea the results are not so uniformly good. Condition is likely to return.

CARCINOMA.—Cancer of the breast does very well in the early stages. Treatment every other day with moderately soft tube for ten minutes. Distance ten inches. Whenever the lesion is at some distance below the skin in this or any other kind of a case, the tube should be correspondingly harder to insure penetration. The results are correspondingly less certain. After the first stages of breast-cancer amputation is the proper remedy. It should be followed by X-ray treatment. In cancer of the stomach, bowels, rectum, uterus or any other deep organ the X-rays, like all high potential force-modalities, relieve pain and produce an alterant effect, thus prolonging life. I have never seen a case cured and doubt whether the reported cured cases of this kind could stand critical analysis. I have known of pain being relieved by the X-ray, that resisted opiates of all kinds. Exposures should be at long range (15-20 inches) with a comparatively hard tube. Ten minutes every day or two.

ECZEMA.—In many cases of chronic eczema, especially the vesicular variety, the X-rays produce a cure. In nearly all cases they relieve itching and lessen or stop the discharge. Treatments with moderately soft tube for three to five minutes every other day. Distance five to ten inches. Constitutional treatment is imperative in all these cases. Locally the high-frequency current seems to be better adapted than the X-rays.

EPITHELIOMA, or common skin cancer, is nearly always curable by the X-rays. Usually located in the face (lips, nose, angle of eye). Patients should be treated every day

for five to ten minutes. Distance of soft tube five to ten inches. If there is much induration of surrounding or subcutaneous tissues, vacuum of the tube should be somewhat higher. As soon as the induration disappears and conditions assume a healthy aspect, the addition of Finsen's actinic rays seems to accelerate the process of repair. Exposures should last from thirty minutes to an hour. In reality this is equivalent to using a force-modality of less rapid oscillation and greater wave-length in order to supplement the work done by more rapid vibration and shorter undulation. The Finsen-treatment can be advantageously added to X-ray exposures as soon as the process of repair has begun. As a substitute for the Finsen-ray in these cases, a (positive) brush-discharge from a static machine (wooden electrode) answers nicely.

FAVUS.—Two cases treated and both cured. Technique same as in the treatment of eczema.

HYPERTRICHOSIS.—I have not been able to produce more than a temporary effect in these cases. Recurrence seems to be the rule.

KELOID.—Results were negative in three cases. Patients were colored.

KERATOSIS SENILIS.—Results are good especially if the excrescence is removed and the remaining denuded surface treated. Technique same as in the treatment of eczema.

LEUKEMIA.—Results seem favorable as shown by general improvement and in a few cases by blood-count. Exposure over region of spleen with comparatively hard tube for ten to fifteen minutes every two or three days.

LICHEN PLANUS.—Out of six cases two were cured, two relieved and two passed from notice. Technique similar to that of eczema.

LUPUS VULGARIS.—In the hypertrophic form, characterized by nodular enlargement and much contiguous involvement the X-rays are superior to the actinic rays of Finsen while the latter are preferable in the ulcerated form. Comparatively hard tube for five to ten minutes every day or

two. In suitable cases the X-rays are almost a specific. In the erythematous form of lupus (seborrhea congestiva) results have not been satisfactory. In two cases aggravation seemed to follow X-ray treatment. The high-frequency current seems to be the proper agent.

PRURITUS.—The neurotic form seems to respond very well. Three cases, two cured, one relieved. Frequent but very short exposures by means of a soft tube. The itching of many skin-diseases is relieved by the X-rays.

SARCOMA.—Results uncertain and seem to vary even in similar cases. Radiotherapeutic treatment should supplement surgical interference. One case of post-nasal sarcoma, which was operated upon and referred to me by a local laryngologist, was cured.

SYCOSIS.—Results are good. Technique as in acne.

TINEA TONSURANS.—Results usually good. Technique as in acne.

TUBERCULOSIS.—In the glandular form the results are good if the infected glands are not too deep. See technique under Cancer of the Breast. In peritoneal tuberculosis I have seen temporary improvement, general and local. Technique as in deep-seated cancer. Tuberculosis of joints responds favorably in many cases, if energetic general and local treatment is added. Technique same as in cancer of the breast. Use a comparatively hard tube. Skin-tuberculosis responds to frequent exposures with a soft tube. Technique as in lupus. In tuberculosis of the lungs X-ray therapy seems to be of doubtful value. The proper agent locally seems to be the high-frequency current applied by means of a double resonator.

The best results from X-ray treatment are obtained in epithelioma of the face, in the hypertrophic form of lupus and in acne. In these conditions the X-rays surpass any and all other agents, because they are painless, are almost specific in their action, and serve an admirable cosmetic purpose, especially in the common skin-cancer of the face. The first and essential condition of success in the use of the

Roentgen rays is knowledge of their physical properties and the effect they are capable of producing on organic tissue. Without any knowledge of this most important part of the subject, the art of skiagraphy becomes amateurish guess-work, the science of X-ray therapy a conglomerate of empirical notions. There can be no progress without logical elaboration of the principles that underlie the work we attempt to do and the technique we adopt. *Sit modus in rebus!*

PART II.

The Practice of Physiological Therapeutics.

THERAPEUTIC INDEX.

Alcoholism.—The *acute* form can be successfully handled in the dry-heat cylinder. Flushing out the stomach and irrigation of the colon should precede the treatment. *Chronic* alcoholism requires isolation, abstinence, active elimination through the skin and bowels and stimulating (hydro-therapeutic or electrical) applications to the lower extremities. Suggestive influence, hygienic surroundings, a vegetable diet are indicated. Symptoms of individual cases should be met when they arise. Daily positive static insulation is very serviceable.

Alopecia.—Baldness may be the result of some constitutional disorder (syphilis, acute fevers) or disease of the skin (eczema, psoriasis, etc.) or may be due to parasitic invasion and gradual destruction of the hair-follicles. The curability of the condition is in direct proportion to the tractability and removability of the cause. This holds good with special emphasis in regard to the first two varieties named.

Localized baldness (alopecia areata) is due to invasion of the hair-follicles by fungoid parasites. The prevalence of the disease in this country is frequently due to ignorance of the first principles of scalp-hygiene. The bad habit of many people hardly ever removing their head-gear deprives the scalp of the benefits of the actinic rays of sunlight. These rays are destructive to germ-life. Exposure to sunlight is, therefore, the first condition of treatment. Liberal use of soap and water is next in importance. In well-marked cases of gradually spreading and coalescing spots of baldness the Finsen-rays and the high-frequency currents are indicated (ten to fifteen minutes of each every day). The application of a negative static head-spray (ten minutes

every day or two) is of value. Cold douches thrown against the infected area have a tendency to stimulate the nutrition and resisting power of the skin. Alternate applications of heat and cold are frequently employed. Exhaustion by means of a suitable vacuum-apparatus is useful, especially if combined with high-frequency applications. X-rays are of doubtful efficacy. The general condition of the patient, especially the excretory functions, should not be ignored. Where the hair-follicles are dead, treatment is useless.

Amenorrhea.—If it is due to some general condition, treat the cause. Hygienic directions are of the utmost importance (fresh air, sunlight, nourishing food, open bowels, active skin-function). Curran Pope advises the use of the general electric-light bath followed by a cold general spray (needle-douche). At the time of the expected menstrual flow, hot foot-baths and a sitz-bath (vapor) should be given. General massage is useful, following a lukewarm general bath (mild faradic current carried by the water). Vibration over dorsal and all lumbar vertebræ should be given every two or three days. Applications of mild galvanic current (ten to twenty milliamperes) every three days for ten to twenty minutes, negative pole over pubes, positive pole on the back. In suitable cases use mild faradic current by means of a uterine electrode, other pole in cul-de-sac or on the back. High-frequency applications by vaginal electrode are useful. Negative static spray over pelvis answers well in some cases. Auto-intoxication as the result of suspended or insufficient menstruation explains many nervous disorders of women, hysteria, melancholia, headache, reflex neuroses, etc.

Anal Fissure.—Positive zinc- or copper-electrode to fissure, negative to abdomen, galvanism three to eight milliamperes for five minutes. If one treatment does not cure, repeat it after eight or ten days. (See HEMORRHOIDS.)

Anemia.—To correct disturbances in the hematopoietic apparatus and its functions a perfect hygienic regime must be instituted. (See chapter on PERSONAL HYGIENE.)

Colon-irrigation, general massage, vibration of the spine, over the region of the spleen and over the solar plexus, a vapor-bath once a week, cold douches to spine and daily sun-baths, with an abundance of gentle exercise and fresh air, are the fundamental conditions of success in the treatment of a case of anemia. The diet should be liberal and nourishing, including more especially green vegetables, salads, cocoa, raw egg, fruit and almost any kind of meat. Spinach, raw egg and scraped beef have always enjoyed a reputation as good foods for anemic persons. Sour, sweet, salty and high-seasoned food is to be avoided. Milk is of questionable value in some cases. Respiratory gymnastics (see TUBERCULOSIS PULMONUM and VALVULAR DISEASES OF THE HEART) and long walks in the woods, especially in cedar and pine woods, are to be recommended. Co-existing conditions should receive proper attention. (See FUNCTIONAL DISORDERS.) The general high-frequency treatment (cage or diasolenic cylinder) is of service in all cases of anemia. Static insulation (positive for neurotic subjects, negative in sluggish cases) or the positive and negative static crown breeze alternately is very useful. The same regime is applicable in CHLOROSIS, PERNICIOUS ANEMIA and LEUKEMIA. Sometimes the X-rays seem to affect leukemic cases favorably. The high-frequency current is equally effective and a great deal safer.

Aneurysm of the Aorta.—Some cases are benefited by systemic dehydration. (See VALVULAR DISEASES OF THE HEART.) The object is to render the blood thick and coagulable. Tufnell's diet consists of bread and milk, each two ounces, for breakfast; bread, meat and milk, each three ounces, for dinner; bread and milk, each two ounces, for supper. Rest in bed with this diet for a number of months. Locally galvano-puncture might be tried (both needles in the tumor; some use only the positive needle in the tumor). The diagnosis offers an interesting radiographic problem.

Angina Pectoris.—During an attack apply a hot pack to the whole thorax and to the lower extremities and a cold

compress to the head. Immersing the patient in hot water up to the umbilicus is beneficial. Other means of breaking up an attack are given under the head of PALPITATION OF THE HEART. Try to locate the cause and remove it. Galvanism (positive over the heart, negative in lumbar region) can be given every day for ten minutes as a heart- tonic. For additional information see FUNCTIONAL DISORDERS, REFLEX DISORDERS, DYSPEPSIA, VALVULAR DISEASES OF THE HEART.

Angioma.—(See VASCULAR TUMORS.)

Aphasia.—Mild faradism (electrode in each infra-maxillary space pressing inward and towards each other) is useful. Same current, frequent interruptions by means of rheotome. High-frequency current over neck, also rapid, mild vibrations. Galvanism (positive over spine, negative over neck, both constantly moving) is useful. Negative static spray in front and on both sides of neck. Look for cause of the condition. (See PARALYSIS and HYSTERIA.)

Aphonia.—Treatment identical with that of aphasia. (See APHASIA.)

Appendicitis.—The treatment of an *acute* attack does not differ from that of acute inflammatory conditions anywhere else in the body. The general principles are discussed under the head of INFLAMMATION (ACUTE) and FEVER. Post-inflammatory irritation is due to a catarrhal condition in the para-typhlitic connective tissue or to a localized chronic inflammation of intestinal or peritoneal tissue in the right iliac space. These conditions are analogous to the catarrhal and the post-inflammatory states in the female pelvis. The common cause of inflammation in the right iliac space (appendicitis, typhlitis, peri-typhlitis, para-typhlitis) is constipation, *i. e.* the retention of waste in the large intestines. Physiologically the large intestines are an unnecessary encumbrance. The appendix is probably a remnant of an additional coil of intestine which has disappeared. The colon is a stagnant sewer and as such the cause of most diseases to which human flesh is heir. (See

COLON-IRRIGATION and FUNCTIONAL DISORDERS.) *Chronic* appendicitis requires eliminative treatment. (See INFLAMMATION, CHRONIC.) Irrigation of the colon is of the utmost importance. Locally positive galvanic applications, gentle massage of the surrounding parts, hot packs are indicated.

Arterio-sclerosis.—The therapy consists in the enforcement of mental and physical rest, open emunctories, especially kidneys and bowels, abstinence from tobacco, alcohol and from medicinal heart-tonics. (See VALVULAR DISEASES OF THE HEART.) Cold applications and intense heat are not safe. Condition is incurable.

Asphyxia.—Strong faradic current (one pole side of neck, other pole over epigastrium) interruption by means of a rheotome every three or five seconds. Cold douches to spine. Make thorax expand and contract.

Asthma.—The regime consists in the enforcement of general hygienic directions, active elimination and locally of mild but rapid vibration or oscillation of the thorax, massage of the muscular framework of the chest, depletion of the circulation in the lungs by hydro-therapeutic treatment of the lower portions of the body. Principles of treatment are discussed under the head of VALVULAR DISEASES OF THE HEART, TUBERCULOSIS PULMONUM, EMPHYSEMA. If there is an underlying cause, it should receive proper attention. (See REFLEX DISORDERS, FUNCTIONAL DISORDERS, DYSPEPSIA, BRIGHT'S DISEASE, CHRONIC.) To relieve an acute attack of spasmodic asthma give patient a hot sitz-bath and alternate hot and cold douches to the back. Galvanism (positive side of neck below ear, negative over anterior chest-wall), weak current, is useful.

In treating a case of hay-asthma (hay-fever) the existence and tractability of a predisposing cause should be taken into consideration. General eliminative and tonic treatment lessens the liability to attacks of this kind by increasing the resisting power of the organism and removing systemic predisposing conditions. (See FUNCTIONAL

DISORDERS and REFLEX DISORDERS.) Positive copper-electrode (galvanic) to nasal mucosa, five to ten milliamperes for ten minutes daily, is useful. High-frequency applications (vacuum electrode) to nasal mucosa frequently give relief.

Auto-intoxication is a condition of the blood produced by the absorption or reabsorption of substances which are foreign to the physiological purposes of the organism. It is by all odds the most prolific cause of chronic diseases, especially the so-called functional disorders. The toxic derivatives which are the true etiological factors in the causation of many chronic diseases, may be products of the physiological digestive secretions and fluids, of normal products of digestion and of abnormal products of bacterial disintegration of normal food. Active putrefaction in the intestinal canal, especially the colon, is produced by different forms of anerobic bacteria. (See reference to organisms of this kind under the head of SKIN-DISEASES.)

The toxic character of these derivatives has been demonstrated by the effects on some of the lower animals that were inoculated with them, *e. g.* rabbits and guinea-pigs. The common symptoms produced were tetanic in character and resembled the spasms which are frequently caused by intestinal troubles in children. Injection of ammoniacal urine sometimes produced fatal results in animals. Absorption of toxins from the alimentary tract usually gives rise to nervous phenomena or cutaneous disorders. Auto-intoxication is the true etiological factor in the majority of cases of headache, vertigo, malaise, biliousness, nervousness, neurasthenia, melancholia, hypochondriasis, the "blues," muscular pains, skin-diseases, nervous diseases, in fact chronic diseases of all kinds. (See FUNCTIONAL DISORDERS, REFLEX DISORDERS, RHEUMATISM, DYSPEPSIA, DIABETES, BRIGHT'S DISEASE, NEURALGIA, etc. etc.)

Bier's Stasis is a therapeutic method introduced by August Bier, of Bonn. It consists in the application of artificially induced passive hyperemia for the purpose of pro-

ducing analgesic, bactericidal, absorptive, solvent and nutritive effects in the treatment of a variety of conditions. The stasis is produced by the frequent and prolonged application of a rubber-bandage above the seat of trouble to partly shut off the arterial supply and produce venous hyperemia. The same effect is aimed at in the application of a specially constructed exhaustion-apparatus, which is placed around the part to be treated (*e. g.* an elbow or a breast), and by means of which the part is surrounded by a relative vacuum. The method, which must not cause pain, has been used with remarkable success in tuberculosis of joints, gonorrhoeal joints, acute and subacute arthritis, chronic inflammations, mastitis, stiff joints, neuralgias, edema, phlegmasia, in fact in all conditions in which analgesic, bactericidal, absorptive, solvent and nutritive effects are indicated. Bier's excellent book on the subject has been ably translated and edited by G. M. Blech, of Chicago.

Birth-marks.—(See VASCULAR TUMORS.)

Bright's Disease (Acute).—The therapy consists of a mild, non-irritating vegetable or milk diet, colon-irrigation, active diaphoresis (dry heat, hot pack, electric-light bath) and many suitable symptomatic measures. (See BRIGHT'S DISEASE (CHRONIC), INFLAMMATION (ACUTE) and FEVER.)

Bright's Disease (Chronic).—The chronic form of nephritis may be one of three varieties, the difference between the three varieties depending on the pathological changes which take place in the kidney or some part of the kidney-structure. The condition known as tubal nephritis, parenchymatous nephritis or large white kidney is characterized by an inflammation or catarrh of the tubules in the renal cortex. Another form of chronic Bright's disease is an inflammatory condition of the connective tissue resulting in a shrinking and hardening of the organ (cirrhosis, sclerosis, chronic interstitial nephritis, small red kidney). After long-continued suppuration in cases of bone-disease, cancer, consumption and other wasting diseases, the structure of the kidney and other internal organs is infiltrated

by a waxy substance and undergoes a lardaceous or amyloid degeneration. The infiltrate, while it causes an enlarged appearance of the organs, presses upon the kidney-structure proper and produces atrophic changes. The condition is known as the amyloid kidney and is analogous to similar conditions in other organs. There are two other forms of chronic nephritis, which, however, are comparatively rare and are not, strictly speaking, to be included under the head of chronic Bright's disease, *e. g.* suppurative nephritis (pus in the pelvis of the kidney) and hydronephrosis (cystic condition produced by retention of urine in cases of obstruction in the ureter or pressure of a growth, the ascending and accumulating fluid gradually causing atrophy of the kidneys by pressure).

The common forms of chronic Bright's disease are the parenchymatous and interstitial varieties. In the former the onset is gradual, the disease pursuing a chronic course throughout, at times involving the inter-tubular connective tissue. The interstitial variety usually co-exists in the latter stages of chronic diseases of the heart and liver. Both varieties are essentially chronic, sometimes lasting for many years. Much can be done towards alleviation of these distressing conditions. Before degenerative changes have occurred, the prognosis under physio-therapeutic regime is favorable in many cases, especially if the condition is not produced by and is not co-existent with some systemic disease or disease of some other organ, *e. g.* the heart. If it is, the treatment would necessarily have to be directed towards the exciting cause.

The triple object of all methods of treatment in chronic Bright's disease is: (1) to re-establish the proper relation of arterial and venous blood-pressure in the kidneys; (2) to prevent the accumulation of waste products in the system, and (3) to relieve incidental symptoms. How perfectly the objects of treatment can be realized by the intelligent application of physio-therapeutic means, can be easily seen in the logical character of these agents and in

the remarkable results which are effected by them even in many cases in which drug-therapy is without avail.

To re-establish the physiological equilibrium of venous and arterial blood-pressure.—To unload the congested structures, various hydro- and thermo-therapeutic applications to the lumbar region, to the anterior abdominal wall and to the lower extremities, are serviceable. The best local application for this purpose is without a doubt the cold moist pack (Priessnitz method). It is indicated particularly in the earlier stages of the disease and only in cases where the systemic symptoms are either absent or are of a very mild type. If the amount of albumen is large and symptoms of uremic poison are present (headache, vertigo, nausea, etc.), hot applications are safer and more effective. The reason for this is obvious and suggests the danger of all cold applications in chronic Bright's disease, more especially if the latter are used over large areas of the body-surface for the purpose of stimulating excretion through the skin. It is a notorious fact that in all cases of kidney-trouble the characteristic reaction upon which the therapeutic effect of a typical hydro-therapeutic application depends is very uncertain and even when it does take place, rather imperfect. The danger of internal congestions following cold application, is a factor which must not be ignored in cases of chronic renal inflammations. The hyperemia in the secondary area which is the result of a cold application to the primary area would mean a disastrous exacerbation of the inflammatory condition, unless by a prompt and vigorous reaction, the primary area becomes hyperemic and the secondary area correspondingly anemic. With a complete and prompt reaction the cold hydro-therapeutic applications would be ideally available in cases of chronic Bright's disease. They would be by their "derivating" action most effective antiphlogistic agents. However, owing to the tendency towards venous congestions in all cases of chronic kidney-trouble and the notoriously uncertain character of reaction, the hot, moist application is by far safer and more effective.

It should be long-continued and often repeated. Incidentally it is a splendid anodyne, if applied to the small of the back. General massage judiciously administered two or three times a week is a valuable depletent agent. It has a diuretic action, increases the amount of uric acid and solids in the urine, stimulates assimilation and facilitates the conversion of albumins in the economy. These effects can be intensified by deep vibration over the first three lumbar vertebræ, given every other day for five or ten minutes. The renal ganglia are thus kept active and well nourished. The tendency in many cases is towards atrophy of the ganglia.

Dietetic directions are of great importance because they are capable of affecting the circulation in the kidneys by lessening the functional activity of excretion. The object is to relieve the effort of renal excretion. Exclude nitrogenous food as much as possible. Milk should be the mainstay of the patient. Suitable quantities of fats, cream-butter and starchy foods should be allowed. Water should be given freely. If digestion is good, weak coffee or tea is not objectionable. Strong coffee or tea should never be allowed. Alcoholic stimulants should be positively excluded, because they are renal irritants in proportion to the amount of alcohol they contain. Irrigation of the colon by means of hot water is useful. The drinking of large quantities of hot water has been recommended by many observers. Raw fruit is of the greatest value in these cases.

Electricity might be employed in various ways in these cases to produce counter-irritant and depletent effects. Galvanization by means of a large (negative) plate-electrode over the lumbar region and a (positive) sponge-electrode at some distance, might be advantageously employed every day or every other day for ten minutes. An indirect static spray or the wave-current with pieces of block-tin applied to the lumbar region is of benefit. A high-frequency current applied by means of a vacuum-electrode to the small of the back, has a good effect, especially in cases suffering from pain in the back.

Similar effects may be produced by the Minin light, the local electric-light bath and the small dry-heat cylinder. The object is to increase the cutaneous circulation and excretion in the lumbar region and to deplete the kidneys in this way. Care must be taken not to overstimulate or even burn the skin.

To prevent the accumulation of waste-products in the system.—The skin in all these cases must be forced to perform a compensatory function. Its activity should be stimulated. In this way the excretion of toxic material is facilitated and the occurrence of grave systemic complications prevented. The advantages of a dry, warm climate are apparent. Cold air contracts the superficial vessels and lessens the activity of the skin. Warm air keeps the skin active. If the air is dry, it enhances the exhalation and evaporation of moisture from the lungs and skin. Patients should be taught to wear woolen underwear.

Therapeutically the employment of intense dry heat is of the greatest value. There is no single therapeutic agent that can be approximately compared to the dry-heat cylinder or the electric-light bath in cases of chronic Bright's disease. In most cases, especially if the heart has not given rise to symptoms on the part of the venous circulation (edema), two or three mild sweat-baths in the dry-heat or electric-light cylinder have the proper diaphoretic and excretory effect. The bath should not be carried beyond the point of tolerance. It should not weaken the patient nor cause too active excretion. The stimulating effect of light makes the electric-light bath especially valuable. After a bath in the dry-heat cylinder the patient should rest for hours and partake of liberal potions of water. On the intervening days the sun-bath is of value. In administering baths in the dry-heat cylinder, gentle diaphoretic effects should be aimed at. It is by far better to give these baths every other day and thus promote continuous excretions without depression than to subject the patient to a powerful drain on his system once a week. Patients of this class do not recuperate very

promptly after depressing sweat-baths. Heart-symptoms frequently arise in cases that had previously been free from circulatory disturbances. If mild baths are administered frequently, the organism usually responds most gratefully



ELECTRIC LIGHT BATH.

(See page 158.)

by continuing moderately active excretion through the skin for many weeks even after the dry-heat treatment has been discontinued. In this way most wonderful improvement can be brought about.

The physiological effects of intense heat which take place in the organism independently of the diaphoretic action, are to a large extent illusory in cases of nephritis. The employment of 200°-300° F., until profuse diaphoresis takes place, is recommended by Winternitz and is advocated by most observers who have had experience in these cases. The object in these cases is elimination.

If the dry-heat or electric-light bath is not available, hydro-therapeutic applications may be employed with advantage. The best are the hot-immersion bath and the hot moist pack. Cold applications are nearly always contra-indicated in these cases. The use of the hot needle-spray (fine douche) is followed by most salutary effects.

In the parenchymatous variety of chronic nephritis constant albuminuria is the rule. Under the dry-heat eliminative treatment the quantity of albumen will gradually lessen, while the quantity of urine may increase. Edematous swellings are gradually absorbed. The number of blood-corpuscles in the urine decrease while the evidences of anemia eventually disappear. In most of these cases the urine is loaded with all kinds of renal casts, epithelium and pus-cells. Urates and phosphates are present in large quantities. By careful examination of the urine the course of improvement during the eliminative treatment can be watched. Casts and blood-cells will disappear while epithelial cells may continue to show. The amount of urates and phosphates slowly diminishes.

In cases of chronic interstitial nephritis the evidences of improvement are even more striking. In these cases certain systemic symptoms predominate while the kidney-symptoms (albuminuria) are frequently absent. The heart-symptoms in these cases are characteristic (hypertrophy of the heart, increase of arterial tension). Casts in the urine are rarely found. Uremic attacks are the rule in these cases. Apoplexy frequently occurs. The eliminative treatment by means of the dry-heat cylinder or electric-light bath lessens the severity of the uremic symptoms. Eventually the

uremic attacks cease. The heart-symptoms are the most stubborn to handle. Owing to the increased arterial pressure and the coincident liability to hemorrhage from ruptured vessel-walls, the treatment must be administered with a great deal of care.

In chronic parenchymatous nephritis the indirect negative static spray is of value. It enhances elimination. In cases of interstitial nephritis the positive insulation may be employed as an effective circulatory sedative. The use of the high-frequency cylinder is indicated in both varieties. The high-frequency current acts as a trophic (vaso-motor) alterant and stimulates the organs which are concerned in the process of catabolism. The use of a mild galvanic current by means of a warm half-bath (positive pole in the water, negative pole to the neck) frequently produces a good effect. Blue-light exposures have been found serviceable in many cases.

The diet of a nephritic subject has already been referred to. I beg to remind the reader that the production of Bright's disease in dogs and men by an exclusive nitrogenous diet has been experimentally shown. A nitrogenous diet is, therefore, contra-indicated in cases of nephritis. The diet should be mixed, with a preponderance of carbohydrates and vegetable albumen. Fats in moderate quantity are allowable. Red meats are less objectionable than white meats. Milk is the most important food. Fruit, green vegetables and rice can be given in liberal quantities. According to Tyson the precise line of dietetic procedure may be facilitated by indicating the daily physiologic quantity of food which is, approximately 110 gm. to 130 gm. of albumin, 350 gm. to 400 gm. of carbo-hydrates, 75 gm. to 110 gm. of fat, 2,500 gm. to 3,000 gm. of water, and 18 gm. to 30 gm. of inorganic salts. Expressed in different terms, the body needs from 2,000 to 2,400 calories per diem during rest, and 2,400 to 3,000 calories during hard labor. This should consist of about 600 calories of proteids, 1,200 calories of carbo-hydrates, and 600 calories of fat. It may

prove helpful to remember that 100 gm. of meat represent 213 calories, and one glass of milk equals 128 calories, and an ordinary slice of bread (30 gm.) equals 64 calories, while 18 gm. of butter equals 8 calories. The maximum amount of food physiologically required is also required in chronic nephritis, otherwise subnutrition will manifest itself by anemia and loss of flesh and strength. The experiments of Van Noorden have shown that, calculating on the basis of 70 kg. body-weight, that in men from 13 to 16 gm. of nitrogen, and in women 11 gm. to 14 gm., are ingested daily by nephritic patients who enjoy good general health. When the ingestion of albumin is increased, so that considerably more than 15 gm. of nitrogen daily have to be excreted by the kidneys, elimination becomes irregular and uncertain. Van Noorden also demonstrated that most medicinal substances (potassium iodide, salicylic acid, quinin, atropin, etc.) are not eliminated by the kidneys but act as irritants, which is a point of some importance in connection with the subject of chronic nephritis. The advantages of water-drinking in these cases can not be too often repeated nor too strongly emphasized.

To Relieve Incidental Symptoms.—Attacks of acute uremia and symptoms due to uremia (headache, vertigo, nausea, vomiting, defective vision, asthma) require active eliminative treatment. Hot baths, dry-heat baths, electric-light baths are indicated. Catheterization and colon-flushing should be practiced in acute attacks of uremia. Hot water should be introduced in large quantities into the stomach and the colon. Forcible dilatation of the rectal sphincter reacts on the vaso-motors of the skin and augments the excretory efforts of the skin.

Irritability of the bladder can be allayed by applications of heat to the supra-pubic region and irrigation of the bladder with hot water. Hot rectal injections frequently give prompt relief. Vibration over the lumbar vertebræ and peripheral vibration by means of a soft rubber tube introduced up to the neck of the bladder are serviceable. Fara-

dization (one pole on perineum, other pole over bladder) is useful. Galvanization answers better in some cases. Static sparks to the perineum and to the lumbar centers are recommended by some. The wave-current applied to the perineum is useful. In some cases the indirect static spray (positive) to the supra-pubic region is of service.

For the relief of edema, especially of the feet, deep centripetal effleurage should be practiced.

Neuralgic pains, which are common in chronic Bright's disease, usually yield to the eliminative measures spoken of. Vibration along the course of the aching nerve is a valuable addition. The effect can be enhanced by a positive static spray or a high-frequency application. Local applications of heat are always serviceable. Cupping (by means of exhaust-pump and vacuum-tube) is useful.

General anemia, weakness and disorders due to disturbance of central nerve-function are best treated in D'Arsonval's cage or in the diasolenic cylinder.

Failure of the circulation, especially attacks of syncope, call for stimulating measures. Cold douches to the back are proper in extreme cases. Faradism applied to the pneumogastric and phrenic nerves, static sparks to the cardiac apex, general faradization in the bath and alternate applications of heat and cold to the cervical and upper dorsal regions will frequently bridge a patient over difficulties of this kind.

If chronic kidney-troubles are secondary to some other disease or co-existent with disease in some other organ, the clinical indications will have to be modified and adapted accordingly.

Bronchitis.—The management of an *acute* attack should be governed by the therapeutic principles given under the head of PNEUMONIA. (See also COUGH, INFLAMMATION (ACUTE) and FEVER.)

The treatment of *chronic* bronchitis (bronchial catarrh) requires careful individualization. Bronchial catarrh in the advanced stages is frequently due to and associated with

diseases of the heart, lungs, kidneys and other chronic conditions. Chronic bronchitis may be due to atmospheric conditions, insufficient skin-function or a catarrhal tendency which is common in persons whose circulation is sluggish. The general features of treatment are discussed under the head of INFLAMMATION (chronic) and COUGH. The local treatment should be adapted to the symptoms of the individual case. Breathing exercises and chest-massage, as discussed under the head of TUBERCULOSIS PULMONUM, are useful in many cases, especially if the cough is dry and periodical (winter-cough). Many electro-therapeutic applications are serviceable, to wit: faradization or galvanization of the vagus (side of neck to intra-clavicular space or epigastrium or moved about), galvanization of the cord (nape of the neck to front of chest), negative static spray to chest, if intra-thoracic congestion is well marked. Vibration over cervical region and over thorax is useful. Electro-therapeutic and vibratory treatment should not last longer than fifteen minutes and should be given every day or two. Inhalation of largely diluted ozone sometimes relieves cough and dyspepsia. A static insulation often checks spasmodic cough. At times a change of climate is necessary. If bronchial catarrh is secondary to some other condition, treat the latter. Recurrent bronchial catarrh in an apparently healthy person should call for energetic measures to harden the patient and to improve the reactive tone of the skin. Cold moist packs to the chest, cold douches to the back and to the thighs and walking in wet grass should be prescribed for the patient. Outdoor sports, especially rowing, swimming and horseback exercise, are very serviceable in these cases.

Bruise (Contusion).—In recent and comparatively mild cases reaction and absorption should be produced by suitable means of applying heat or counter-irritation (thermic cylinder, Minin light, electric-light bath, exhaustion by cups as suggested by Bier, hot-water applications, immersion in hot-water bath). After treatment with any of these agents, the skin should be lubricated and massage gently and uni-

formly applied to help in the distribution of extravasations and exudations. Static spray and galvanization (positive pole to affected area) are sometimes useful. When absorption has begun local applications of a high-frequency current are of advantage. If the contused region is very extensive, heat and massage should be depended upon. If the arm or leg is the seat of the contusion, constant immersion in hot water (flowing, if possible) is indicated. If the injury to the tissues is so severe as to have caused sloughing or gangrene, the constant immersion in hot water is by far the best treatment. It preserves the viable elements and facilitates excretion of the discharges and sloughs. In this way it promotes repair and prevents sepsis, not to speak of the prompt and decided analgesic effect. In these cases no other treatment should be resorted to as long as there is any morbid material left in the affected part. In superficial cases exposure to sunlight is beneficial. If the bruises are multiple and involve different parts of the body, the whole body should be immersed in hot water and then subjected to gentle stimulating massage. The electric-light bath and the sun-bath are very useful in these cases. If extravasation is considerable, vacuum-cupping should be resorted to. The application of cold is contra-indicated in cases of contusion.

Calculi.—The statement made by Schroth that concretions in the bladder, kidneys and liver are but rarely found in vegetarian animals, seems to have a deep therapeutic significance in the treatment of the underlying condition. It is essential to increase the watery constituents of a patient's diet. Schroth's statement is borne out by the comparative rarity of calculi among the Chinese. Radiographically it is of interest to know that gall-stones offer little or no obstacle to the X-rays and can, therefore, not be skiagraphed. I have come to this conclusion after at least a dozen attempts to skiagraph gall-stones which had been removed surgically and were placed directly upon the envelope containing the plate. In one or two instances a very faint shadow was produced, probably due to the presence of a large quantity

of bile-pigment or lime-salts. Gall-stones held up to the fluoroscopic screen by the hand of the operator can not be seen. The statements made by Wm. B. Snow in his excellent book on Static Electricity, etc., in regard to this subject I have not been able to verify.—The internal use of hot olive oil in the treatment of gall-stones is to be commended. The effect is mechanical.

Cancer.—(See chapter on X-RAY THERAPY, also INOPERABLE MALIGNANT DISEASE and GASTRIC CANCER.)

Compressed Air.—The use of the pneumatic chamber should be based upon the knowledge of the effects that can be produced and of the possible dangers. The effects of compressed air are retardation of the number of respiratory movements, increase in the depth of the latter; lessening of the frequency of the heart-beats, depression of the capillary circulation, increase in the amount of waste-products, notably urea and CO₂ and variable effects on the nervous system (depression and languor in some, stimulation and excitement in others). Clinically the best results have been achieved in emphysema, delayed absorption of the pleural effusion, valvular diseases of the heart with imperfect compensation; fair results in anemia, chlorosis, affections of the middle and internal ear, pertussis, capillary hemorrhage, diabetes, obesity and cerebral congestions. A compressed-air treatment is said to facilitate the reduction of hernia. The compressed-air chamber is contra-indicated in all forms of capillary bronchitis, for mechanical reasons in ascites, hydro-thorax, abdominal tumors, in disease of the heart muscle, high fever, hemorrhagic tendency and in the last stages of tuberculosis. *Compressed* air is sometimes called *condensed* air. The effects of rarefied air are suggested by the indications which are met by high altitudes (mountain-air). Rarefied air acts favorably in all cases of disturbed cellular nutrition, disorders of metabolism, and, therefore, in disease of the respiratory and circulatory apparatus. (See TUBERCULOSIS PULMONUM.) The reader is referred to P. L. Tissier's excellent monograph on PNEUMO-THERAPY.

Chancroid.—Copper-electrode (positive) should be applied to ulcer, negative pole anywhere. Galvanic current should be applied strong and long enough until metallic electrolysis is complete, which is shown by the green color of the cupric oxychloride. Negative electrolysis is painful and not as satisfactory. Concentrated chemical rays (Finsen) followed by thermic rays (Minin) usually produce a good result.

Bubo.—(See SEPSIS and SYPHILIS.)

Chancre.—(See SYPHILIS.)

Chilblains.—Positive copper electrode locally, negative sponge electrode elsewhere, galvanism three to five minutes every day or two, ten to twenty milliamperes. Vibration, massage and heat to surrounding parts.

Chorea.—St. Vitus' dance is often a reflex phenomenon and may be due to dental troubles, worms, eye-strain, menstrual disturbances, masturbation, tight foreskin, etc. Try to find the cause and remove it, at the same time giving the patient the benefit of rational hygienic treatment. The patient should be kept physically and mentally quiet, food should be non-stimulating (vegetable), the bowels should be kept open, the bladder-function should be watched. General eliminating treatment (sun-bath, thermic cylinder, electric-light bath) is indicated in most cases. Galvanization (mild current, positive to occiput and down spine, negative to feet) is useful. Galvanic warm bath (negative in water, positive to back of neck) is sometimes employed. Static (positive) spray to head and spine or positive static insulation can be given every day for ten minutes. The general high-frequency treatment in the diasolenic cylinder is very effective. Effleurage over stomach, chest and back followed by resistance-movements of the lower extremities, with the patient lying down, is recommended by Busch, who states that out of one hundred and eight patients suffering from chorea and treated mechano-therapeutically as indicated, only eight were not relieved. The resistance-movements have a fine sedative effect. Some of the choreic

patients suffer from rheumatism. In these cases massage and sweat-baths are indicated.

Colon-irrigation is one of the most important sanitary and therapeutic agents in the treatment of most diseases. It is administered for the purpose of cleaning out the large intestines. In this way absorption of toxins (auto-intoxication) is prevented and the nerve-supply of the abdominal organs stimulated through the solar plexus, which is not infrequently in a semi-paralytic condition from the pressure

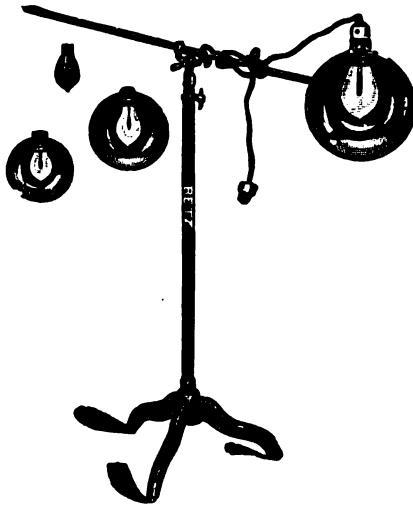

A MININ EQUIPMENT.

(See page 157.)

of a distended transverse colon. The patient is placed in the knee-chest position, shoulders down, hips elevated. A well-greased rectal tube is now introduced up to or beyond the sigmoid flexure and warm water from a fountain syringe is allowed to flow through the rectal tube into the descending colon. The water soon fills up the descending and transverse portions of the colon and finds its way into the ascending portion, especially if the patient turns on his back and helps in the distribution of the water by firm

lneading of the abdomen. Colon-irrigation is not usually a success the first time. The patient may complain of griping and inability to hold much water. With each succeeding attempt less difficulty will be experienced in getting water into the colon. The patient should persist until he is successful. The effect of thorough colon-irrigation must be experienced in a number of cases in order to be thoroughly appreciated. In the treatment of chronic diseases its value is positively inestimable.



POSITION OF THE BODY FOR COLON-IRRIGATION.

Constipation is always an effect of some pre-existing cause and as such secondary to the condition to which treatment should be directed. Abstracting from purely extraneous causes which may produce constipation, *e. g.* the plumbism of lead-workers and the habitual use of opiates or bismuth, there may be mechanical reasons why the bowels do not evacuate their contents with physiological regularity. Such mechanical causes are malformations of the intestinal canal, malignant or cicatricial strictures, the

pressure of a tumor or of a misplaced or enlarged neighboring organ, adhesions involving the serous coat of the intestines and the presence of unusually large rectal valves.

The causes mentioned are of comparatively little importance because they concern but a small percentage of the cases. Heredity is a questionable etiological element, although some authors seem to attach some importance to it. In keeping with the causative factors which are at fault in the vast army of constipated individuals, especially women, we may recognize four varieties of constipation, to wit: the atonic, the neurotic, the metabolic and the trophic (dietetic) form.

Atonic constipation is produced by and associated with atrophy of the muscular coat of the intestines and a coincident dilatation of the bowels (*enterectasis*) and, as a subsequent effect, a dropping of the vastly dilated intestines out of their normal position (*enteroptosis*). The primary etiological factor in these cases is either neglect in attending to the function of daily defecation or the existence of some form of gastric dyspepsia or the habitual use of cathartic or laxative drugs.

The *neurotic* form of constipation is coincident with many disorders of the nervous system, notably structural diseases of the cord, *e. g.* tabes. Functional disorders of the nervous system, including the almost numberless varieties of neurasthenia and hysteria, are frequently the causative factor.

The *metabolic* variety of constipation, as the name indicates, is coincident with and produced by certain disorders of metabolism. The excessive sweating of corpulent and obese persons abstracts moisture from the tissues of the body and in this way causes the fecal matter to become dry and hard. Anemia frequently produces constipation by poor blood-supply and imperfect nutrition of the intestinal walls. The passive congestion often associated with organic diseases of the heart and lungs, may bring about a constipated condition. In this connection it may be of interest to state

that dark-skinned persons are more frequently constipated than individuals with fair skin. Owing to the absence of pigment in the latter and the ready entrance of actinic sunlight, the process of oxygenation is much more active and general nutrition more perfect.

Trophic (dietetic) constipation supervenes in persons whose dietetic habits are at fault, *e. g.* in those who eat an excess of meats. This phase of the subject is illustrated by the notorious constipation of the carnivorous animals as contrasted with the easy and copious defecation of the plant eaters.

The modern treatment of constipation may be presented under the head of the various psychic, physiological and mechanical means at our command.

SUGGESTION.—That the control of mind over matter refers in no uncertain manner to the defecatory function, is admitted on all sides. The effect of a powerful and suitable suggestion given by the medical attendant will often manifest itself in the form of active peristalsis and is not infrequently seen in the action of a bread-pill which the patient takes under the impression that a strong cathartic has been administered. Concentrate the patient's mind on the bowel-function and add to this concentration the suggestion of an evacuation to occur at a certain time. This frequently paves the way for a cure, especially in neurotic subjects. Encourage the patient to go to the closet at a certain time every day. In many cases the auto-suggestion will have the desired effect, if the patient persists in the effort.

DIET.—According to Boas, diet is our mainstay in the cure of constipation. The dietetic directions given by this author enjoy a well-merited reputation in Europe. They represent a splendid criterion for the average case. Tell the patient to drink several glasses of fresh water immediately after rising in the morning. In some cases hot water with a little table-salt seems to answer better. This should be followed by a brisk walk in the open air for not less than

thirty to forty-five minutes. The patient is now ready for his breakfast, which should consist of coffee or sweet milk, oatmeal, Graham- or rye-bread and plenty of fresh fruit. Honey should take the place of butter although the latter is not objectionable in the majority of cases. Sometimes a breakfast consisting of rye-bread and plenty of buttermilk is relished more than the *menu* given above. After the breakfast the patient should again walk for fifteen to thirty minutes, and, following this, make a determined effort to defecate.

The midday meal should consist of palatably prepared vegetables of any kind (peas, beans, spinach, cabbage, etc.), rye-bread and butter, and plenty of fresh or cooked fruit of any kind. A glass of light wine is permissible. Boas allows the patient any kind of meat for the midday meal. The author has made it an invariable rule to exclude meat and has never had occasion to change his ideas on this subject. Man was originally a vegetarian. Exclusion of meat from his diet simply means a return to the original natural state. (See chapter on DIETETICS.)

The evening meal should consist of rye-bread and butter, milk and plenty of fresh or cooked fruit. Before retiring an apple or an orange might be allowed. Fresh buttermilk is an excellent beverage and should be frequently given during the day. There is no objection to fresh water during or between meals, except in cases of well-marked dilatation of the stomach (atony, gastrectasis) in which the drinking of large quantities of water is for obvious reasons undesirable. There is no objection to an occasional glass of light wine or beer, preferably ale, especially if the patient is in the habit of indulging in stimulants of this kind. The patient should not be allowed more than one or two cups of coffee throughout the day. In neurotic cases it is frequently advantageous to exclude coffee and substitute a non-stimulating beverage. In regulating the diet the personal equation of the patient must not be lost sight of. The principal feature should be the enforcement of a rigid vegetable

regime. Fruit, fresh or cooked, is by all odds the best food for most patients suffering from constipation. Pure cider is hardly ever objectionable.

IRRIGATION OF THE COLON is an agent of unquestioned value in all cases of constipation. It should be practiced two or three times a week before retiring. The apparatus should consist of a fountain syringe, to the nozzle of which is attached a rectal tube or a good-sized catheter, which is introduced into the rectum full length. The water should be warm. After the patient has received fully a quart or more of water, he should lie on his back with his knees drawn up and his mouth open. Beginning in the left iliac space and following the course of the descending, transverse and ascending portions of the colon, gentle massage should be given to help in the distribution of the water and the softening up of the fecal matter. (See COLON IRRIGATION, FUNCTIONAL DISORDERS and AUTO-INTOXICATION.)

MASSAGE OF THE ABDOMEN is useful in many cases. It should be given three times a week, always on an empty stomach. If the physician himself is not an adept in the art of massage, it is best to either desist from giving it or leave this part of the treatment to one who is familiar with the principles and practice of the art. The manipulations should be deep and in keeping with the anatomical structure of the intestinal canal. The superficial manipulations of most masseurs and masseuses are worthless and not infrequently irritating to the skin and subcutaneous tissues. The value of a well-fitting abdominal bandage in cases of gastric and intestinal dilatation complicated with constipation is worthy of mention. In constipated persons whose abdominal wall contains a thick layer of adipose tissue, a well-fitting bandage will help not only in the reduction of the "bay-window," but also in the cure of the constipation. Cannon-ball massage by the patient on himself is not infrequently productive of good results. Wearing an anal plug-dilator of suitable size often relieves constipation.

EXERCISE (*active and passive*) is an essential part of

the treatment. Walking is good, horseback exercise is better. It stimulates metabolism and secures for the organism the untold benefits of fresh air and light. The so-called "Swedish movements" are of great value. Let the patient lie down on his back and slowly rise to a sitting position with his arms folded. Let him slowly return to the dorsal decubitus. This movement should be repeated twenty-five times morning and evening. The firm contraction of the abdominal muscles is the curative agent in this form of exercise. The latter can be varied by letting the patient stand and slowly bend over until his fingers touch his toes. There is no end to the variety of different forms of active and passive exercise in the treatment of constipation. In some cases of constipation characterized by extreme gastric and enteric dilatation and a general collapse of the nervous system, the enforcement of prolonged rest, as suggested by Weir Mitchell ("rest-cure") is not infrequently of great benefit. The art of applying the "rest-cure" in these cases consists in knowing when the physiological moment has arrived to substitute stimulation (exercise, etc.) for enforced rest.

HYDRO-THERAPY.—The use of the cold douche or pack on the abdomen in the morning is very useful, especially in persons whose circulation is good. The reaction which follows the douche results in an increase of arterial blood in the abdomen and coincident intensified metabolism and functional activity not only of the skin but the intra-abdominal lymphatics. The cold douche is the simplest and most useful hydriatic application in these cases. Much will depend on a physician's power of individualization. Much harm is sometimes done by the indiscriminate use of cold water. In patients whose circulation is sluggish, the hot douche or warm application would be safer than the use of cold, but is by no means as effective. The alternating hot and cold douche on the abdomen is a splendid local tonic in suitable cases.

ELECTRO-THERAPY.—The secondary faradic current, applied to the anterior abdominal wall by means of two sponge-

electrodes which are shifted about constantly, is a simple and useful application. Sometimes it is of advantage to place either pole on the back and the other pole on the anterior abdominal wall. For this purpose a flat abdominal electrode is useful. This form of faradization can be combined with abdominal massage, the operator holding one sponge in one hand while he gives massage with the unen-



THE OSCILLATOR.

(See page 135.)

gaged hand, the patient holding the other sponge in one hand. The galvanic current is frequently useful. A rectal electrode is connected with the positive pole, a flat abdominal electrode being attached to the negative side. Rapid interruptions by means of rheotome enhance the effect. Static electricity, both in the form of a negative spray applied to the abdomen and in the form of sparks to the spine and abdomen, represents a valuable addition to the therapeutic means at our command. The wave current applied to the abdomen and pushed to the point of tolerance acts well in

the atonic form of constipation. In the neurotic form the various kinds of high-frequency currents are of value and frequently bring about rapid results when other forms of electricity seem to be without avail.

VIBRATION AND OSCILLATION.—Oscillation enhances the effect of massage and faradism. The different varieties of constipation represent probably the most promising field for a good oscillator. The simplicity of technique is a point in its favor. Vibration is more difficult of application, but a splendid therapeutic agent in the hands of a good operator. The application should be made peripherally by deep and coarse vibration over the abdomen in the direction of the peristaltic movement. Centrally it should be applied by deep and rapid strokes to the lower dorsal and upper lumbar vertebræ to stimulate the centers which control the functions of the different sections of the intestinal canal. Vibration should be practiced every day for not less than fifteen minutes. The employment of rectal vibration by means of a special rectal attachment is frequently very serviceable, although in many instances too irritating locally to be of much value.

Speaking collectively, it is safe to say that the best and promptest results may be expected in cases that are treated by massage, faradism, galvanism and vibration. Dietetic regulations are a *conditio sine qua non* in all cases of constipation. (See chapters on PERSONAL HYGIENE and DIETETICS.)

Corns.—The pain of a corn is often relieved by a positive static brush or spray. A positive galvanic current locally is useful.

Cough.—Inasmuch as cough is always a symptom, its management can not be separated from the treatment of the cause. As a means of excretion it is salutary in character, *e. g.* in cases of pneumonia, bronchitis, tuberculosis, etc. It is only when the cough is dry, incessant, distressing and seemingly uncalled for and ineffective that measures should be adopted to relieve and, if possible, remove it.

REFLEX COUGH.—Cough may be produced by irritation of the pneumogastric and phrenic nerves in cases of heart-trouble, dyspepsia, diseases of the liver, tumors or inflammatory swellings pressing on and irritating the nerves named. Displacements and other abnormal conditions in the cervical spine may cause cough. The abdominal viscera, especially the internal sexual organs of women may, by irritation of their nerve-supply, set up cough, the irritating impulse being carried by sub-plexus and sub-ganglia to the solar-plexus, nerves of the stomach, liver and diaphragm and finally to the respiratory nerves (*e. g.* morning cough of drinkers). Vibration over the lower cervical and upper dorsal vertebræ, together with faradization or galvanization of the vagus is very useful. It is plain that treatment of the cough must at all times be secondary to the treatment and removal of the cause.

CONGESTIVE COUGH.—It is associated with and produced by inflammatory, congestive or catarrhal conditions of any part of the respiratory mechanism (bronchitis, pneumonia, etc.). In addition to treating the underlying cause, the cough can be relieved by inhalations of vapor, warm applications to the chest and depleting hydro-therapeutic applications to the feet. Exposure to electric light (local apparatus) is useful. Cold douches to the cervical spine frequently relieve congestive cough, especially in old catarrhal cases. If the cough is moist, *i. e.* a means of excretion, it should not be interfered with.

NERVOUS COUGH.—It differs from the first named variety by being apparently independent of any pathological condition in any part of the organism. It is produced by psychic or temperamental causes. Cases of this kind are hard to handle. Suggestion sometimes does good. Static spray on the spine can be tried as a suggestive agent.

MECHANICAL COUGH.—It is due to foreign bodies in the air-passages, inhalation of irritating vapors, gases and other substances and may be caused by an elongated uvula. Injudicious ozone-inhalation sometimes produces a most

distressing and stubborn cough of this kind. Treatment in all these cases depends on the cause.

SYSTEMIC COUGH.—It is due to constitutional disease of some kind, *e. g.* rheumatism, gout, plethora, syphilis. It is an evidence of auto-intoxication and can not be cured unless the cause is removed.

LARYNGEAL COUGH.—It is characteristic on account of its metallic intonation and is produced by pertussis, inflammation of the larynx, disease of the laryngeal structures, aortic aneurism, mediastinal tumors and other conditions irritating the recurrent laryngeal nerve. Positive electricity (galvanic, static) applied directly to the larynx frequently acts as a sedative.

Cough is never a disease *per se* and for this reason the etiological factor must be sought for and treatment given accordingly. Some of the unsuspected causes of unaccountable cough are dilatation of the stomach, worms, constipation, tight prepuce, menstrual disorders, hemorrhoids and locomotor ataxia. Try to find the cause in keeping with the classification given above and treat accordingly.

Cirsoid Aneurism.—(See VASCULAR TUMORS.)

Cicatricés.—Negative electrolysis.

Cystitis.—The *acute* attack requires rest, open bowels, hot applications over pubic region and perineum, hot rectal injections, derivating packs to the abdomen and lower extremities, drinking of water in copious quantities and a mild vegetable or milk diet. (See INFLAMMATION (ACUTE) and FEVER.)

Chronic inflammation of the bladder, in addition to the directions given above, requires the use of clear warm water for irrigation. Locate the cause of the bladder-catharrh and try to remove it. (See INFLAMMATION, CHRONIC.) Locally galvanism (positive over the bladder, negative on the back), positive static spray or high-frequency current might be used. Vibration over the lumbar vertebræ helps to regulate the local circulation. Local elec-

tric-light bath is beneficial, followed by a vapor sitz-bath. In cases of non-inflammatory irritable bladder weak faradic secondary current applied in or near the bladder, negative to abdomen, also galvanic (positive over pubes, negative to feet, ten milliamperes ten to twenty minutes every day) are useful.

Dandruff.—Improve the nutrition of the scalp by hot water, high frequency applications (daily for 15 minutes) and negative indirect static sprays (daily for 10 minutes). Expose scalp to fresh air and sunlight as much as possible. Clipping the hair is frequently of advantage. The general condition should not be lost sight of. See SKIN DISEASES.

Deafness.—Pneumatic massage by means of a special pump-device operated by an electric motor is serviceable in catarrhal deafness. If the case is recent, some good might be done by the use of dry-heat (Hopkins' device). Cataphoresis of potassium iodide is advised by some. Pack auditory canal with cotton soaked in saturated solution of K I. Attach to negative pole of weak galvanic current for ten minutes every other day, positive pole on opposite shoulder. In neurotic deafness use high-frequency current with ear vacuum-electrode. Pack ear with wet cotton and apply positive pole of galvanic current, negative on opposite shoulder, three to five milliamperes for five to ten minutes every day or two. Vibration over mastoid is useful in some cases.

Derivation is the act of depleting one part by drawing or forcing the blood into other part. Theory and practice of derivation are discussed in the chapter on THE THERAPEUTIC EFFECTS OF HEAT AND COLD.

Diabetes Insipidus.—Ideal hygienic surroundings and the enforcement of every detail of personal hygiene are the prime conditions of treatment. Colon-irrigation should be practiced in every case. The diet should include nitrogenous and carbo-hydrate foods to suit the palate and stomach of the individual patient. Fats, too much meat, spices, highly seasoned foods, pastry and very rich articles of food

are objectionable. For general regime and symptomatic therapy see **DIABETES MELLITUS**. The galvanic bath (positive in water, negative to back of neck) is often beneficial.

Diabetes Mellitus.—The management of a case of diabetes is largely a hygienic and dietetic problem. The disease is probably the result of a disturbance in the nervous mechanism which controls metabolism. The hygienic therapy should include everything that is likely to regulate the organic functions. Fresh air at all times, sun-baths as often as possible, open emunctories and freedom from mental and physical strains of any kind are the elementary conditions of treatment. The skin should be kept active by two eliminative baths or packs a week, followed by a brisk dry rub-down. A Priessnitz compress to the abdomen at night, followed by cold sponge-bath in the morning, should be habitually resorted to. Colon-irrigation is advisable every other day. Deep massage of the muscles of the extremities and resistance-movements of the same have a tendency to improve general health. Later on systematic gymnastic exercises should be prescribed, preferably in the open air to enhance oxygenation of the blood.

The diet of a diabetic patient demands the exclusion of sugar and starches. According to most authors a strongly nitrogenous diet is indicated. Townsend's dietetic directions for diabetes include all varieties of meat, such as beef, veal, mutton, fowl, game, pork, tongue, brain, sweetbread, kidneys, marrow of bones, cured meats, fresh fish, shell-fish, preserved fish, also oils, eggs, milk, cheese, nuts except chestnuts, endives, spinach, beans, peas, onions, leek, asparagus, cabbage, meat-soups without sugar or flour. Fats and oils are especially useful. Lettuce has from time immemorial enjoyed the reputation of being almost a specific in diabetes. This is a popular belief concerning what is certainly a splendid restorative for diabetics. Weak coffee without sugar is permissible. Alcohol and tobacco are strictly interdicted.

The patient, according to most authors, must positively

abstain from ordinary bread, sugar, jelly, sweetmeats, pastry, ice-cream, sweet wines, sweet fruit, cereals, starches of any kind, potatoes and honey. Gluten and bran-bread, without the starch of flour, are permissible.

Libraries have been written on the subject of diet for diabetics. The prominence which is given to meat is open to criticism. Nature frequently inhibits the forced meat-diet by causing the patient to experience a well-marked nausea at the very sight of meat. A moderate meat diet seems to meet the indications much better. The objections to bread seem to be ill-founded because most diabetics crave wheat-bread and thrive on it. Green vegetables are always permissible. The preponderance of fats and oils in a diabetic patient's diet is of doubtful propriety. Vegetable fats are a splendid food for diabetics. The marrow of the coconut yields a fat (*oleum cocois*) which, according to Liebig and Fresenius, does not contain fatty or mineral acids and seems destined to serve as a food of greatest value. It has been found very serviceable in the dietetic management of diabetes mellitus. Alcohol is not altogether without value in these cases. A glass or two of fine old Rhine or Moselle wine daily may be allowed, especially if the patient is accustomed to alcoholic stimulation.

The enforcement of active exercise, supplemented by massage, daily baths, cold douches to the back and thighs, is of overpowering importance because metabolism and oxidation must be stimulated at all hazards. The thermic cylinder and the vapor-bath can be advantageously employed. Excessive weakness, a tendency to fainting and cerebral symptoms are contra-indications to the employment of too active elimination through the skin. The object of all therapeutic agents in this disease should be to improve general health and prevent loss of weight.

Vibration of the muscles of the extremities and also over the dorsal vertebræ is frequently of benefit. A daily high-frequency treatment in the diasolenic cylinder or in D'Arsonval's cage is a most useful adjunct to the treatment. The

wave-current applied to the entire spine and over the lumbar region has been found serviceable. A static insulation or a negative crown-breeze is often beneficial. The value of the arc-light bath can not be overrated. Symptomatic therapy is often necessary to meet special features of diabetic cases. (See FUNCTIONAL DISORDERS and REFLEX DISORDERS.)

Diarrhea may be due to the presence of irritating substances in the alimentary canal and is the effort made by nature to eliminate the offensive material. It may be due to impaired innervation of the bowels or to inflammatory conditions in the intestinal canal. Sometimes it co-exists and is directly connected with certain general diseases (Bright's disease, cancer, diabetes) and represents nature's eliminative efforts.

As long as the stools are offensive, the diarrhea is salutary and should not be interfered with. High injections (colon-irrigation) should be given for the purpose of diluting the deleterious material and facilitating its discharge. To enforce rest of the intestinal coats the patient should abstain from food entirely for a day or two or even longer. There is no better way of compelling the organism to absorb inflammatory material than by suspending the function of food-assimilation. The three remaining emunctories (skin, lungs, kidneys) assume the task of normal excretion and exercise their activity in a compensatory way. Augmented skin-function (dry-heat cylinder, electric-light bath) abstracts fluids from the alimentary canal and counteracts the tendency towards too frequent and copious evacuation. Colon-irrigation by means of starch-water can be used after the acute stage is over. Locally hot applications over the abdominal wall are serviceable. A positive static insulation has a general sedative effect and enhances the action of the therapeutic measures named. On the second or third day the patient can be fed to light articles of food. (See GASTRITIS.) If diarrhea is a concomitant symptom or phenomenon of some constitutional malady, the latter should receive proper attention. During the convalescence after

an attack of diarrhea, alcoholic stimulants (red wine, claret, port) serve an excellent purpose. The regime outlined applies to the acute as well as the chronic form of the disease.

Diet in Acute Fevers.—To establish the proper proportion between the rapidly oxidizing tissue-consumers and the needed tissue-builders, the latter should be given in relative excess. To facilitate digestion and assimilation, liquid or semi-liquid food is preferable to solid food. In all acute fevers soups and broths should constitute an important part of the diet. Beef-broth, mutton-broth, chicken-broth, vegetable soup, beef-tea can be given in small quantities at a time. In the manner of preparation and serving, it is of advantage to please the eye and the palate of the patient. Milk, hot or cold, with or without lime-water, properly prepared rice-water, barley-water, very soft oatmeal, rice, a soft-boiled egg, milk-toast, eggnog, buttermilk, soaked crackers, gruel, white of egg beaten up in barley-water, offer a plentiful variety to choose from. In typhoid fever solid food is particularly objectionable on account of the ulcerated condition of the intestines. Fever-cases should be fed frequently with a small amount of food at a time. A point which is of importance and usually neglected is the hygiene of the mouth in fever-cases. Before and after every meal or feeding, a fever-patient should be given a chance to cleanse the oral cavity, especially the lips and the teeth. If the patient is unable to do this, the attendant should do it for him. Clear, lukewarm water answers very well. Clear, cool drinking-water should always be freely allowed in all fever-cases.

Drug-habits.—In all but advanced cases the use of the drug should be stopped abruptly. It is by all odds better to let a patient fight it out until nature comes to his rescue. In the meantime his general health should be improved by general massage, spinal vibration and different kinds of water-applications. If patient has lost much in weight, allow a rich, nitrogenous diet provided the stomach will stand it. Fresh air, sunlight, active exercise and open bowels

should be insisted upon. The electric-light bath is very useful in most of these cases. In extreme cases no general directions can be given. All cases of drug-addiction ought to be treated in an institution equipped for this purpose.

Drugs.—The idea that drug-methods and physio-therapeutic methods can be indiscriminately combined to mutually assist and supplement each other, is not unconditionally correct in principle and might prove disastrous in practice. Drugs that are likely to upset the stomach, that disturb metabolism and are accumulative in their action, should never be given when physio-therapeutic methods are followed. Patients that are taking salicylates, iodides, digitalis, pilocarpine, mercury, or worm-medicines should not be treated in the dry-heat cylinder, the electric-light bath or general pack, unless the dose of the drug taken has been very small. The action of saline laxatives is much enhanced by massage and vibration of the stomach. The enforcement of a strictly vegetable diet makes a patient more susceptible to all drugs that affect the circulation and metabolism. The doses of these drug-agents should be correspondingly reduced. The dehydration-method of Oertel is incompatible with digitalis or arsenic. (See VALVULAR DISEASES OF THE HEART.) Massage, Swedish movements and vibration are of uncertain value if the patient is taking mercury in specific doses. Patients who are taking bromides should not be treated with static electricity, especially if they are of a neurotic temperament. High-frequency currents applied by means of vacuum-electrodes are very irritating if the patient is taking Fowler's solution. I have seen a true dermatitis develop in more than one case of this kind. The physician should never forget that dry-heat, electric-light and hydro-therapeutic treatment affect metabolism so markedly and deeply that the administration of drug-agents becomes an entirely new proposition. So-called therapeutic doses become poisonous doses under these circumstances. Even the character of the drug-action might change. The

statements made are based upon a varied experience along these lines.

Dysentery.—The treatment of the *acute* form of the disease consists in rest, diet, irrigation and other therapeutic measures, outlined under the head of DIARRHEA. Absolute cleanliness about the person of the patient, the bed and the room is necessary on account of the infective character of the dysenteric discharges.

The treatment of *chronic* dysentery is identical with that of chronic diarrhea. Starch-water irrigations and the use of alum and other astringents are indicated in the ulcerative form of the disease. Hot water per rectum is a splendid anodyne in some cases. In other cases cold water seems to be more effective. Alcoholic stimulants in small doses are indicated in most cases of chronic dysentery (red wine, port wine).

Dysmenorrhea.—If it is due to obstruction of the cervical canal, follow directions given under STENOSIS. If it is the result of a co-existing inflammation or catarrh of the body or neck of the uterus, treat the cause. In the membranous form of dysmenorrhea use a galvanic current (twenty to sixty milliamperes, negative pole in uterus, positive pole on abdomen, for ten minutes every third day, beginning ten days before the menstrual period). If patient is a virgin, place positive on back, negative on pubes, twenty milliamperes, ten minutes every other day. Let patient sit in a lukewarm bath (water carrying a mild negative galvanic current). Static positive insulation and negative breeze to back are useful. Faradization (one pole over pubes, the other on lumbar region, weak current every other day for fifteen minutes) sometimes prevents an attack. For additional therapeutic directions see AMENORRHEA. The dry-heat cylinder can often be advantageously employed in cases of dysmenorrhea.

Dyspepsia (Chronic).—Dyspepsia in its various forms is the classical type of a chronic disease. It is the most common of all chronic diseases and surpasses in point of

symptomatic variety any or all other diseases. Among the chronic cases that go from one doctor to another without getting much relief, the various forms of apparent or disguised stomach trouble represent by far the largest percentage. It is especially the disguised forms of gastric disorder that are very much in evidence without their presence even being suspected. The stomach is the dog in the manger. Many a patient who is being treated for nervousness, hysteria, neurasthenia, hypochondriasis, insomnia, headache, muscular rheumatism, neuralgia, imperfections of sight,

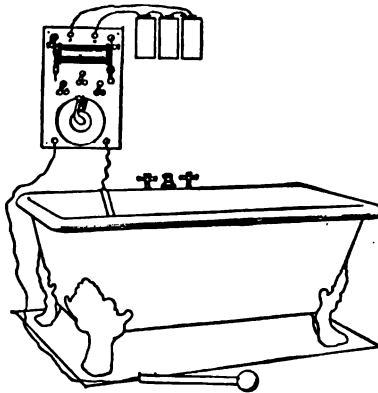

THE HYDRO-ELECTRIC BATH.

(See pages 219 and 221.)

vertigo, heart-trouble, eczema and many other forms of skin disease, is a dyspeptic and can not get well because the dyspeptic condition remains unsuspected, unattended and unimproved. Physiological therapy has taught us to go back to the cause, the actual and primary reason for any existing condition. We are not satisfied to make a symptomatic diagnosis at any time. Any layman who has a smattering of medical terms can make a diagnosis of lumbago, sciatica, vertigo or chronic eczema. The physician who is satisfied with this kind of a diagnosis could reasonably not be expected to do any more for his patient than to prescribe the

stereotyped salicylates, iodides, bromides and salves. The diagnosis and the treatment are on a par. They are unworthy of the name. The modern physician wants to know the reasons for certain symptoms. He evolves the treatment from the etiology and adapts it to the pathological and symptomatic picture presented by the individual case.

The term "dyspepsia" expresses difficulty in the performance of gastric digestion. Inasmuch as gastric digestion is a most important phase in the process of nutrition (anabolism), it is directly related to the well-being of the whole organism and all its parts. If gastric digestion is disturbed, the functional activity of the intestinal canal, especially the small bowels, is usually impaired at the same time. In other words, gastric indigestion does not usually exist without some impairment of intestinal digestion. That the existence of dyspepsia should manifest itself in a thousand different ways, is not surprising. Any part of the organism might give evidence of malnutrition, auto-intoxication and resulting functional impairments. The effects of dyspepsia might manifest themselves at some point of least resistance and might be modified by the peculiarities and idiosyncracies of the individual organism. Thus we can explain the kaleidoscopic variety of symptoms that the individual case might present. These symptoms might be suggestive of stomach trouble (by directing the attention of the medical attendant to the stomach) or misleading (by appearing in some part or structure apparently in no connection with the stomach, *e. g.* in many cases of sciatica and numerous neuroses). Remember once for all that in cases of chronic rheumatism, neuralgia and neuroses, skin diseases and in the endless chain of disorders of the liver and bowels, you can always win half the battle and frequently the whole if you know how to handle the stomach. The symptomatology of dyspepsia is unlimited because the stomach is the most important organ of nutrition. Impairment of its function may mean malnutrition of the whole organism or of some special part or region. Through the nervous system, es-

pecially the vaso-motors, the gastric trouble may be reflected to some distant part, apparently in no way connected with the actual cause of the trouble. Through the pneumogastric and phrenic nerves, the diseased stomach may cause symptoms on the part of the diaphragm, the heart and the respiratory apparatus. Continued pressure of a dilated stomach posteriorly may cause inhibition of the function of the numerous nerves that form the closely communicating and vastly ramifying network of the solar plexus and the ten smaller plexus that spring from it. In this way the structure and function of all the abdominal viscera may be more or less seriously impaired. (See FUNCTIONAL DISORDERS and REFLEX DISORDERS.) Constipation is usually present. There is no end to the chain of reflex symptoms that are liable to be produced by a dilated stomach and may deceive the physician in regard to the true nature of his patient's ailment.

If you have a case of any chronic disease that has stubbornly resisted all attempts at treatment, give that patient the benefit of the doubt and make a provisional diagnosis of dilatation of the stomach. It is the condition that has been variously called catarrh of the stomach, atony of the stomach, gastrectasis, chronic dyspepsia, etc. If your patient habitually has a coated tongue, let him lie down with the knees drawn up and the diaphragm relaxed (mouth open). If palpation of the epigastrium causes distress or discomfort, or if you can cause the stomach to give evidence of the presence of gas and water (gurgling, splashing, succussion), the diagnosis is complete. An examination of this kind should be made on an empty stomach.

The objection might be raised that the term dyspepsia is not suggestive of any well-defined pathological condition, but rather of an impairment of function which might be due to and co-existent with any number of conditions. When we remember that all subdivisions and varieties of functional diseases of the stomach are due to the same cause, to wit; disturbance of nutrition of the stomach as an

organ, it becomes clear that the above objection does not hold good. As long as the circulation in the walls of the stomach is physiologically normal, the function of these walls and of the several functioning structures contained in them must necessarily be physiologically perfect. We know that the circulation is regulated by the sympathetic (trophic, vaso-motor) nerve-supply and that, in turn, the function of the nerves depends upon their blood-supply. Thus we can readily see the close relative connection which exists between the nervous system and the stomach. Thus we can understand why nerve-disorders, psychoses, neuroses, etc., are likely to be closely associated with disorders of the stomach and why, in turn, stomach disorders are liable to manifest their presence through reflex nervous phenomena. It makes no practical difference in the eradication of the cause whether there is hyper-acidity, absence of ferments or any other subvariety of gastric indigestion. All these conditions are results, not causes nor pathological states *per se*. There is absence of tone in the walls of the stomach, due to changes in the nutrition (circulation) in the walls or exhaustion of the nerve-supply of the stomach, resulting in a weak condition and flabby state of the muscular coat. The varieties of dyspepsia are results thereof. This is the clinical meaning of dyspepsia. If the condition continues for a long time, it produces atrophy of the muscular coat, venous hyperemia of the mucosa and proliferation of connective tissue. The stomach becomes baggy, flabby, atonic. It loses the power of expelling the gaseous products of fermentation. Thus the stomach becomes dilated. For this reason we look upon some degree of dilatation of the stomach as being associated with and necessarily consequent upon all forms of chronic dyspepsia.

How can we treat and cure a case of dyspepsia, using the term "dyspepsia" in the sense indicated? The local treatment consists in massage, vibration, electricity, diet and colon-irrigation. The general treatment should aim at

stimulating and correcting metabolism. For this purpose the employment of superheated air and high-frequency currents is indicated.

MASSAGE.—The immediate effect of manipulation of the stomach is the production of active hyperemia. The epigastrium is warmed up, the blood-supply of the stomach and the continuous structures are changed by the afflux of fresh arterial blood and the consequent depletion of the veins, the absorbent glands are stimulated, the walls of the stomach and transverse colon eventually make a faint effort at peristalsis. The solar plexus, which presides over the assimilative functions of the abdominal organs (not inappropriately called the *abdominal brain*) receives a powerful impetus which reverberates throughout the sympathetic nervous system and stimulates metabolism in all parts of the organism. Gradually the contractile and digestive efforts which the stomach makes become more energetic. The pressure symptoms are temporarily relieved by the first treatment. In rare cases this does not occur. The prognosis then is accordingly less favorable. The technique of stomach massage is as follows:

The patient lies on his back with his knees elevated, and breathing through his mouth. The operator stands on the left side of the patient, placing his right or left hand upon the patient's epigastrium. Deep but gentle pressure with the ball portion of the hand alternates with pressure by the inner surfaces, not the tips, of four fingers; at the same time the whole hand of the operator is rocked to and fro carrying the whole epigastrium with it without sliding over the skin. The operator's hand must at all times remain in firm contact with the patient's skin and carry it along. The treatment should never be given after a meal and should never cause pain. Contra-indications are acute gastritis, ulcer and cancer.

VIBRATION.—The vibrator is a valuable therapeutic agent in the hands of a well-informed operator. Deep vibration over the epigastrium to stimulate the nerve supply of

the stomach should be given. Gentle, rapid vibration along the course of the phrenic (side of neck to epigastrium) is very effective in helping the stomach to expel the gas. Deep vibration along the fourth to the eighth dorsal vertebræ frequently has an excellent effect.

ELECTRICITY.—A weak faradic current (rapid interruptions) should be allowed to pass through the stomach with one pole in the pit of the stomach, the other pole on the back. Polarity is indifferent. Sometimes the operator grasps one sponge-electrode with the unengaged hand and allows the current to pass while massage is being given, the patient's hand holding the other electrode. Faradization of the vagus is excellent. A galvanic application is often useful (negative pole in the pit of the stomach, positive pole on the back). An indirect negative static breeze is beneficial, if applied to the stomach in atonic cases. Some cases do well under a high-frequency current, applied to the epigastrium by means of a suitable glass electrode. No electro-therapeutic application should last longer than ten minutes nor be given oftener than once every other day.

DIET.—Exclude fat and well-done meat. Direct the patient to eat slowly, chew thoroughly and take little food at a time. Find the kind of raw fruit that the patient's stomach will stand. Milk, as a rule, should be avoided, like all articles of food that are liable to ferment. Put the patient on a largely vegetable diet, avoid sugar, starches and fats. Meals should be small. Patient should be given a chance to appease his hunger, but not to crowd his stomach. It is important to individualize each case in connection with the selection of the proper vegetables. Fresh water is always indicated, buttermilk sometimes, beer rarely. Light wine in water is permissible. Ice-cream and all cold articles should be positively forbidden. When improvement becomes manifest, patient can be tried on raw eggs or rare lean meat. Remember that you can not do much harm by under-feeding, but you can kill your patient by over-feeding a dilated stomach. Liquids in large quanti-

ties are injurious because they dilute the gastric juice too much and have a tendency to drag the stomach out of its position by their bulk and weight. An hour's nap after a meal is to be recommended.

Colon-irrigation should be given twice or three times a week, with the patient in the knee-chest position.

GENERAL TREATMENT.—In many cases of chronic dyspepsia the skin is sallow, dry and ill nourished. Put such a patient into the superheated air-cylinder at least once a week to stimulate skin function and metabolism. Tone up the patient's general system by a general high-frequency treatment in the body diasolenic twice a week.

The wearing of an abdominal bandage is often an excellent means of counteracting the tendency of the stomach to gravitate out of its normal position (gastroptosis). A patient should be encouraged to get as much light and air as possible. In all disorders of nutrition and metabolism, fresh air is a therapeutic agent of wonderful efficacy because it adds oxygen to the physiological combustion which is going on in the economy. Light stimulates the skin-excretion and is, therefore, an important factor.

The laboratory methods of studying the diseases of the stomach (chemical examination of gastric fluids, test-meals, etc.) have yielded comparatively little in a practical way. If the human stomach were a chemical test-tube, we could, by demonstration and deduction, glean much information of positive practical value in reference to the disorders of the stomach. There is an element of life in every organic being which makes the laboratory work of the physiological chemist, however interesting and praiseworthy his efforts may be, a vague uncertainty. This element of individual life is what Pettenkofer has called the "physiological subjectivity of the individual." It is the physiological personal equation of the patient's organism. It is the undefined, intangible element of individual life. A dozen cases of dilatation of the stomach may yield a dozen different chemical results to the analyzing physiological chem-

ist. Every one of these cases improves under the treatment outlined above. Chemical tests indicate the return to the normal condition. All this goes to show that correction of structural changes is followed by a restoration of function. Why one dilated stomach should yield chemical results indicating an increase, a decrease or an absence of a certain chemical constituent of the gastric fluid while another case shows a disproportion of an entirely different character, and why both cases upon proper treatment, especially massage and diet, improve even to the extent of producing normal secretions, is one of the biological mysteries that will never be solved until the veil is lifted from life itself. Experience has shown that physiological chemistry has added comparatively little to the rational therapy of diseases of the digestive organs.

In handling chronic dyspepsia, it is essential to individualize each case. The one all-important fact to be remembered is that even in an advanced case of gastric atony dilatation, dyspepsia), the symptoms do not necessarily point to the stomach. The appetite may be good and even ravenous. The bowels may be regular. The symptoms may all be of the nervous type: insomnia, excitability, neuralgia, defective memory, headache, dizziness, nervousness, drowsiness after a meal, feeling bad after a nap, worry, hypochondriacal manifestations, hysteria and even insanity. There may be backache, paralysis, heart symptoms, rheumatism and one or the other of the almost innumerable forms of auto-intoxication. (See FUNCTIONAL DISORDERS and REFLEX DISORDERS.) In all non-parasitic and non-luetic skin-diseases always look to the stomach. Add whatever special features of treatment, locally and generally, may be required in the individual case. If malnutrition has given rise to neuralgia, muscular pains or skin-troubles, do not neglect these outward manifestations or results while trying to remove the cause. Relieve symptoms by suitable means (massage or electricity in pains of nerves and muscles, high-frequency currents in skin diseases, not to speak

of the vast therapeutic possibilities offered by hydro- and thermo-therapy.) In a general way it may be said that in the treatment of all chronic diseases the physician will never make a mistake if he includes the stomach in his clinical reasoning. When I was a student of medicine, I had a professor who was in the habit of repeating the following admonition so frequently that it became a byword among the students. He was wont to say: "If you do n't know what is the matter with your patient, look wise and give him iodide." From a therapeutic standpoint a worse statement could not be made. The physio-therapist who has gathered experience in the treatment of chronic diseases, is in a position to revise the above statement for the benefit of the many unfortunate chronics who have run the gauntlet of drug-medication and of doctors. The admonition should read: "If you do n't know what is the matter with your patient, act wisely by treating him for atony of the stomach." The results in not a few stubborn and obscure cases justify the diagnosis and compensate for the effort.

Electro-cautery.—For the purpose of heating up a cautery-electrode the lighting circuit (direct or alternating), the storage battery or primary cells are available. The resistance of a cautery is rarely more than 1-10 ohm with a voltage of from 2 to 6 and variable amperage of from 1 to 50, depending on the construction of the electrode. A cautery-battery can not be used to furnish incandescent light. A light current requires higher voltage to overcome high resistance while the current strength is comparatively low.

Emphysema.—The rational therapy of this typical chronic disease is suggested by its pathology. Locally there is an enormous passive hyperemia, systemically we find all the evidences of ill nutrition and functional torpidity. The skin is dry and sallow, stomach and bowels usually inactive, symptoms of auto-intoxication are common. (See FUNCTIONAL DISORDERS.) The disturbance in the pulmonic circulation eventually affects the heart and the general circulation. The general regime outlined under the head of

VALVULAR DISEASES OF THE HEART is entirely proper in the treatment of emphysema. Above all things stimulation of the cutaneous circulation is of paramount importance in order to counteract stagnation in the lungs and subsequent effects on the circulation at large. This should be the object of mechano-, thermo-, hydro- and photo-therapeutic procedures. The surroundings and habits of the patient should be hygienically perfect. Mountain-climbing and inhalation of compressed air, as suggested by Oertel, are a fine therapeutic combination. Chest-exercises, as outlined under the head of TUBERCULOSIS PULMONUM, are valuable.

Vibration can be used to augment massage of the extremities. It can be given over the chest and over the cervical vertebræ. Galvanism (positive over chest, negative on nape of neck; or to side of neck below ear and to epigastrium) is useful. Let patient sit in a warm bath (positive on nape of neck, negative in water) for ten minutes every other day. Static insulation (negative), also static spray (positive) over chest, are serviceable. The general high-frequency application (cage or diasolenic) is valuable. Applied to the spine by means of a vacuum-electrode, the high-frequency current is a fine respiratory and circulatory stimulant.

Endometritis.—The management of an *acute* inflammation of the lining membrane of the uterus should be conducted according to the principles laid down under the head of INFLAMMATION (ACUTE). Attention to the functions of the bladder and bowels is important, if necessary with the aid of the catheter and the fountain syringe. Warm vaginal douches twice daily, warm sitz-bath or local electric-light bath daily and hot application to the lower extremities (vapor, moist packs). A Priessnitz compress on the abdomen has a fine depletent effect.

The *chronic* variety of the disease is one of the most common diseases of women. For general directions see INFLAMMATION (CHRONIC). The most important rule for the local treatment is the enforcement of cleanliness and the stimulation of the local circulation by means of hot

vaginal douches. The galvanic current renders excellent service in these cases. Negative electrolysis is indicated in most cases (negative uterine electrode, positive abdominal electrode, twenty to forty milliamperes, fifteen to twenty minutes every three days). In hemorrhagic cases positive electrolysis with copper electrode in uterus, negative electrode on abdomen, dosage, etc. as before. Electrode must be released by reversing current before withdrawing. (See ELECTROLYSIS—Part I of book.) In reversing the current, always turn it off first and then reverse, in order not to shock the patient. After the treatment a vaginal vacuum-electrode can be used to administer a high-frequency current for the purpose of producing a local alterant effect.

Massage of the local extremities to help in the depletion of the pelvic congestion is useful. Certain Swedish movements augment the effect (bending the feet, knees, hips with the patient resisting; lying down and slowly raising the body from the hips up to the sitting posture). These movements increase the circulation in the lower extremities and abdominal wall. Cold douches to the femoral region with the patient standing have a powerful depleting effect.

Vibration, both central and peripheral, is a valuable agent. Centrally it should be applied to the two lower dorsal and three upper lumbar vertebræ with light and rapid strokes for three to five minutes every other day. Peripherally the application can be made with a flat vibrating attachment over the pubic region. The knees of the patient should be drawn up, patient breathing through the mouth. This form of peripheral vibration is out of the question in very fat subjects. Intravaginal vibration recommended by some, is of doubtful value in these cases.

Static electricity is frequently indicated. The best application is probably the positive spray to the pelvis. In many cases, especially if pain and hemorrhage are prominent symptoms, suspension of sexual relations is imperative. Additional therapeutic directions are found under INTRA-PELVIC INFLAMMATIONS.

Enlarged Tonsils.—Positive electrolysis with platinum-needle, short applications, negative pole in hand, five to fifteen milliamperes for five to ten minutes every day or two. Negative electrolysis with flat metal-electrode to surface of tonsil or by steel-needle in the tonsil, positive pole in hand, continued until dehydration shows, to be repeated every day or two. Galvano-cautery is useful.

Enteritis.—Acute inflammation of any part of the intestinal canal should be managed according to the general directions given under the head of INFLAMMATION (ACUTE), PERITONITIS, GASTRITIS, FEVER.

The treatment of chronic enteritis (intestinal catarrh) is largely a hygienic and dietetic problem. (See DYSPEPSIA, INFLAMMATION (CHRONIC), COLON-IRRIGATION and the chapter on PERSONAL HYGIENE and DIETETICS.) Hot applications should be made to the abdomen. Bowel-symptoms should be treated in keeping with the indications. (See DIARRHEA and APPENDICITIS.)

Epilepsy.—Lesions of the nervous system (traumatic, syphilitic) are but rarely the causes of epilepsy. The disease represents an impairment of functional equilibrium which might be due to any cause capable of disturbing nerve-function. (See FUNCTIONAL DISORDERS, NEURASTHENIA, HYSTERIA, DYSPEPSIA.) The therapy of the disease includes the suggestive influences of a good and well-regulated home-life and the educational advantages of association. Perfect hygiene in the surroundings, the daily life and in the dietetic and sexual habits of the patient should be enforced. Look for exciting causes (tight prepuce, menstrual disorders, alcoholism, sexual aberrations, constipation, etc.). Eliminating treatment supplemented by measures to tone up the system should be instituted. Galvanism once daily is useful (positive head, negative back of neck; also positive to back of neck, negative in warm bath). Positive static spray to spine or head, also positive static insulation are valuable. Vibration over dorsal vertebræ can be given every day. Patient should be kept free

from excitement. Tobacco, alcohol and meat should be avoided. (See chapters on DIETETICS and PERSONAL HYGIENE.) In epilepsy, as in all so-called functional diseases of the nervous system, suggestive therapy systematically employed is of the greatest value.

Fatty Degeneration of the Heart.—The therapeutic directions given under the head of VALVULAR DISEASES OF THE HEART (systemic dehydration) are applicable. Sunbaths, the thermic cylinder, the general electric-light bath are serviceable. In conjunction with these dehydrating measures, the patient should be given a tissue building (nitrogenous) diet: beans, peas, lentils, spinach, roast-beef, beef-steak, lean mutton, game, eggs, with moderate quantities of carbo-hydrates. Liquids should be given sparingly. The patient might be given one cup of weak coffee (tea), milk, one small plate of soup and one glass of water daily. This is an average allowance. Patients soon become accustomed to these small quantities of liquid food. The sensation of thirst can often be quieted by gargling with fresh water. The general dietetic regime should be closely adapted to the individual patient's condition. Rest in the recumbent position several hours a day is very beneficial. Massage, Swedish movements, etc. should be practiced, as suggested under the head of VALVULAR DISEASES OF THE HEART.

Fever.—The true nature of fever as a restorative agent has been repeatedly indicated in this book. (See THE PHILOSOPHY OF PHYSIOLOGICAL THERAPEUTIC and THE THERAPEUTIC EFFECTS OF HEAT AND COLD.) Fever is accelerated and intensified oxidation. Its systemic effects are those of more active and more rapid tissue change. Its outward manifestation is elevated temperature. The latter is of no concern unless it exceeds certain limits and endangers the integrity of the tissues and the organism at large by coagulation of somatic albumen and by the consequent disintegration of vital nerve-centers. Hyperpyrexia of this kind is sometimes found in cases of sunstroke, rheumatism, etc., and is usually fatal. Under ordinary circumstances the

elevation of the temperature is physiologically and clinically secondary to the increased oxidation which consumes the tissues of the body and aims at restoration of normal conditions by regenerating the body and, in doing so, getting rid of disease-producing and disease-constituting material. To lower the temperature means nothing unless it be preceded by and associated with removal of the cause which gives rise to the pyrexia. (See TYPHOID FEVER.) This indicates the sophistry of what is done clinically in the way of antipyretic treatment, especially by means of the so-called coal-tar derivatives. The modus operandi of the latter is plain. The red corpuscles of the blood which are the true carriers of the heat-producer (oxygen) are disintegrated in large numbers by the coal-tar products. Oxidation lags as a result, and the temperature, the external evidence of the oxidation, drops. The heat-units are excreted through compensating action of the skin. Hence, there is diaphoresis and usually considerable weakness. Cyanosis is due to temporary retention of CO_2 and lessening of oxygen. Physiologically this kind of antipyresis adds an additional element of danger to the already existing difficulty. The physician should never address his efforts to the elevated temperature but to the underlying causative factor. Therein lies the philosophy of the hydro-therapeutic fever-treatment.

There are certain features of fever-treatment that apply in all morbid conditions characterized by elevation of temperature. The first rule of action is: Open the emunctories. The bowels should be moved, the kidneys stimulated and, above all, the skin should be made to perform the lion's share of excretion. This holds good in all feverish conditions.

In the acute exanthemata especially during the stage of active eruption cold applications are contra-indicated. The skin should be stimulated by heat, preferably by a steam-bath or vapor-bath, which can be given to the patient while he lies in bed. The technique is simple. Two good-sized

hoops are cut in two, and the four pieces placed over the patient from the neck to the feet. A sheet of some water-proof material is placed over these hoops, which thus serve to keep the sheet from resting on the patient. The head of the patient is left out. The sheet should reach from the neck to below the feet and be closed at both ends. An alcohol-lamp or gas-burner is placed on either one or both sides or at the foot of the bed. By means of one or two good-sized tubes of some sort the hot air or vapor is directed into the space between the sheet and the patient. In

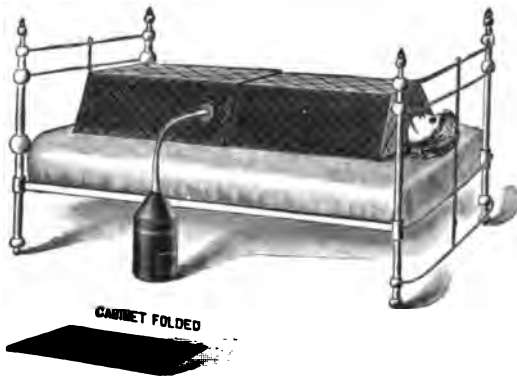

VAPOR-BATH FOR A BED-RIDDEN PATIENT.

this way the patient's skin can be made to excrete freely. This application illustrates the antipyretic effects of heat.

The diet in all fevers should be tissue-building to compensate for the loss entailed during the tissue-consuming fever-process. (See DIETETICS.) For obvious reasons liquid or semi-liquid food, frequently given in small quantities, is indicated in all fever cases. (See DIET IN ACUTE FEVERS.)

To counteract enervation from long-continued pyrexia, the cold sponge-bath (*Abreibung*, *Abklatschung*) or douche should be resorted to. The nervous system is wonderfully upheld by these means.

Fibroid Tumors.—Negative electrolysis. (See Part I of the book.) Negative pole near tumor (on abdomen

Modern Physio-Therapy.

(in uterus) ten to one hundred milliamperes for ten to twenty minutes every four or six days. Positive pole on neck. In hemorrhagic cases reverse position of the poles given above. Use copper or zinc tip with positive pole. Reverse current to release positive electrode before attempting to remove it. Use of needle is dangerous and not more effective than method given. Apostoli uses two hundred and more milliamperes in his negative electrolytic method. Good symptomatic cures are sometimes effected by using ten to thirty milliamperes for ten to fifteen minutes every other day, positive pole in the uterus if the tumor is sub-mucous or intra-mural. In the sub-peritoneal cases Apostoli's method (powerful negative electrolysis) is more effective.

Fistula in Ano.—Introduce a metal probe throughout the full length of the canal and connect with positive pole of a galvanic current. Technique as given under ANAL FISSURE. Treatment ought to be repeated every week. Sometimes negative electrolysis (negative pole to probe) seems to answer better. For general directions see HEMORRHOIDS.

Flexions of the Womb.—In cases of forward bending (anteflexion) of the uterus, the cause should be taken into account and treated (metritic, peri- and para-metritic conditions, fibroids, etc.). The uterus should be massaged loose from adhering neighboring structures. Acute inflammatory symptoms are a contra-indication to massage. Faradization is useful (mild current for 15 minutes every other day, one pole beyond the cervical canal, the other pole high up in the rectum resting on the body of the flexed uterus). If the uterus is ill-nourished, galvanization can be substituted. Pessaries are worse than useless. In cases of backward-bending (retroflexion) of the womb the prospects of a cure are not very bright. Massage might be employed to break up adhesions and help the uterus to maintain its natural position. Faradization (one pole to the uterus, the other in the bladder) has been recommended by

Tripier. The treatment of anteversions and retroversions does not differ in principle from that adopted in flexions of the uterus.

Freckles (Lentigo).—Negative electrolysis with very fine steel needle. Positive pole in hand.

Functional Disorders.—That increase, decrease or perversion of function can not exist *per se*, but is necessarily associated with and dependent upon structural or nutritional changes in the cellular elements whose functional activity appears accentuated, diminished or altered, is a generally admitted physiological principle. It is clear, therefore, that there can be no functional disorder *per se*. The functional activity of cell-elements of an organ or structure depends upon their nutrition. If the latter is increased (hyperemia), stimulation of function must necessarily follow. If nutrition is so active that the cell-elements can not appropriate or assimilate it, the result is a violent reaction characterized by all the evidences of over-nutrition and coexisting stasis. This condition involves exhaustion of the functional power and is known as active congestion or inflammation. If the cell-elements of an organ receive less than their physiological share of nutriment (anemia), functional power will necessarily and proportionately be depressed. If they receive the wrong kind of nutriment (ischemia), deviations from the normal functional standard might be the result. If the blood carries morbid elements of any kind, *e. g.* derivatives of germ life or of normal secretions or excretions of the organism, toxins and various products of a retrograde metamorphosis, the cell-elements might give rise to erratic functional manifestations. (See AUTO-INTOXICATION.) If the affected cell-elements happen to belong to some nerve or nerve-plexus it is plain to see that an infinite number and variety of manifestations might result therefrom. The closely and intricately interwoven network of the nervous system may receive an impulse or suffer an irritation at any one point: the result might be some motor or sensory disturbance in the area controlled by that particular nerve or

REFLEXES. The impulse or irritation might be transmitted by continuity of structure through interlacing sympathetic nerves and might cause symptoms or manifestations in any one place and of an entirely different character from that of the original stimulus, impetus or irritation. Therein lies the pathology of the so-called reflex disorders. The transmission of impulses of this kind follows the direction of least resistance. Why a certain path offers less resistance than any other and why, therefore, manifestations of a certain kind follow, is not easy to determine. Therein lies the difficulty of accounting for these reflex disorders. There is no doubt, however, that undue irritability of a nerve-fiber indicates a loss of resisting power or tone and is also an evidence of increase, decrease or perversion of nutrition.

Both functional and reflex disorders are only secondarily connected with the activity of the nerve-mechanism. Primarily they must be aberrations of nerve-nutrition for reasons cited above. It is clear, therefore, that the study of nutrition and, therefore, of the blood, is of paramount clinical importance. The physician should remember at all times that the blood is the medium of metabolism. It is the carrier of food, of fuel, of heat and of waste according to certain physiological laws. It receives food through the lungs and through the stomach. It assumes different forms of consistency, composition and character in keeping with the activity of the different organs. It carries the food elements to the lungs and exposes them to oxidation. It deposits waste in the organs of excretion. Thus we see that the blood is the factor upon which metabolism hinges. If metabolism in any of its phases or in any part of the body is disturbed, the blood is concerned primarily. Secretions may fail in their natural function and undergo chemical changes. Excretions and combustion products may be retained and again enter the circulation. All these substances are foreign to the physiological purposes of metabolism, and, therefore, are to all intents and purposes poisons. Their

presence in the body is equivalent to an ischemia, and may give rise to an endless and numberless variety of symptoms of poisoning through malnutrition (perverted nutrition) of the organism, wholly or in part. This is what is meant by auto-intoxication, the most powerful, the most variable and the most neglected etiological factor in the production of disease and its symptoms. It is the pathology of most so-called functional and reflex disorders. It is the one factor which explains the clinical features of many chronic diseases.

In the non-parasitic skin-diseases auto-intoxication of some sort or other is the dominating etiological factor. Toxic conditions of the skin-nerves may cause changes in the trophic condition of the skin. The disease may be coincident with an intense eliminative effort made by the skin (*e. g.* in syphilis). In all non-parasitic skin-diseases the condition of the skin is secondary to the toxic state which prevails within the system and finds its outward expression in the cuticle. To go into detail and describe the pathological changes in the skin is of no diagnostic value because all these changes are secondary to the actual causative factor which precedes the disease of the skin, to wit: a disturbance of local or general metabolism. This explains the futility of local treatment in these cases and liability to recurrence.

In view of all these facts we are prepared to understand the philosophy of the Hippocratic dictum concerning the four emunctories. (See chapter on PERSONAL HYGIENE.) The prophylaxis of disease lies largely in physiological excretion. The cure of disease, especially chronic disease, depends on our relative ability to promote, control and regulate excretion. This is what gives hydro- and thermotherapy their commanding place in clinical medicine. In all chronic diseases auto-intoxication is the one factor that must be reckoned with and must be conquered. With these facts in our mind we are able to understand the nature of rheumatism, the symptomatology of many diseases of

women, and, above all, we are prepared to attempt the treatment of diseases of the nervous system that are so universally misinterpreted and unsuccessfully handled. We are ready to admit that functional and reflex disorders have no pathological significance because they are invariably secondary to and symptomatic of some underlying disorder of nutrition.

General and local elimination is the keynote of treatment in all functional disorders. Irrigation of the colon is indispensable. In most persons the colon is a stagnant sewer full of filth and infection. Metschnikoff believes that man would live to an average age of one hundred and fifty to two hundred years if it were not for the fact that he carries the germs of decay and death constantly in his large intestines. The importance of colon-irrigation can not be overrated in cases of functional disorders due to ill-defined causes. Its effect should be supplemented by general elimination through the skin (electric-light bath, thermic cylinder). General massage can be added. The diet should be non-nitrogenous in all these cases. The patient should be taught the hygienic value of water-drinking. The local treatment depends entirely on the indications presented by the individual case. Above all things try to find the source of all the trouble. Try to understand the philosophy of auto-intoxication as a causative factor of disease. Study the function of the several organs that might be concerned in the production of a toxæmic state. In the order of their relative importance as disease-producers, they are: the stomach, the colon, the uterus, the liver, the kidneys. Some forms of auto-intoxication are familiar, like rheumatism and chronic Bright's disease. The obscure and unidentified varieties that are caused by disorders of the stomach and colon represent the bulk of chronic functional diseases without a well-defined clinical or pathological identity, especially the many conditions classified under the head of Hysteria, Hypochondriasis, Neurasthenia, Nervousness, Paralysis, Neuroses, Reflex Disorders and Diseases of the Skin.

Gastric Cancer.—In the first stages of the disease the patient should be restricted to a copious vegetable diet with as little liquid food as is compatible with the patient's comfort. Koumiss is a most valuable dietetic article for these cases. Irrigation of the colon, stimulation of the skin by dry heat or hot packs and sun-baths are to be prescribed. The object of a regime of this kind is to make a profound impression on metabolism and prevent the rapid systemic degeneration which gastric cancer produces. Life is prolonged in this way (Schroth). In the latter stages of the disease treatment is purely symptomatic. The X-rays have an anodyne effect in some cases. The relation of meat to cancer is referred to under the head of **INOPERABLE MALIGNANT DISEASE.**

Gastric Ulcer.—The vast majority of cases of ulcer of the stomach occur in anemic and chlorotic subjects. That anemia and chlorosis are predisposing factors, if not causative conditions of gastric ulcer, seems certain. The general condition of the patient should receive the first attention of the physician. (See **ANEMIA.**) The diet of the patient must be restricted to milk, rice and food-drinks mentioned under the head of **GASTRITIS.** Fruit-juices, cocoa, light wine, are permissible. Sometimes rectal alimentation must be resorted to. Locally all violent forms of therapy (massage, vibration, etc.) are contra-indicated. The general regime is more important than the local treatment.

Gastritis.—*Acute* inflammation of the stomach requires rest generally and locally. Irrigation of the stomach per os and of the colon per rectum is indicated at the beginning of the attack. The diet should consist of small quantities of liquid or semi-liquid food. Water in which oats, barley, rice has been boiled is a splendid article of food. The white of egg beaten up in water is very serviceable. These food-drinks should be seasoned and served to suit the individual patient. Feeding per rectum is sometimes necessary. Hot drinks have a sedative effect on the stomach and are indicated to control vomiting. The general features of the

proper regime are suggested under the head of INFLAMMATION (ACUTE) and FEVER. If gastritis is caused by a corrosive or otherwise irritating poison, the treatment should be begun with proper measures to neutralize the irritating effect of the poison. Massage is contra-indicated in acute inflammation of the stomach.

Chronic gastritis (catarrh of the stomach) should be handled according to the principles laid down under the head of INFLAMMATION (CHRONIC) and DYSPEPSIA. Lavage of the stomach is indicated in cases of catarrh of the stomach characterized by large quantities of mucus. Drinking one or two pints of water before meals frequently takes the place of the stomach-tube. In the advanced stages of gastric catarrh the walls of the stomach thicken while the glandular structures atrophy. This form of practically incurable stomach-trouble is often found in drunkards.

Goitre.—In the *simple* variety of the affection the use of galvanism (wet sponge electrodes on both sides of the neck, negative over the growth, ten to twenty milliamperes for ten minutes every other day), may be tried. Some recommend cataphoric application of saturated solution of potassium iodide by means of a wet cotton-pad or piece of blotting paper with negative pole, fifteen to twenty-five milliamperes for ten to fifteen minutes every other day. Negative electrolysis by means of needles thrust into the growth is not without danger (slough, suppuration, erysipelas, hemorrhage, etc.) The effects of vibration in the interscapular region and also to the goitre direct, recommended by some, are largely illusory. A small positive static spray applied locally has been known to be beneficial. Tight collars and corsets should be discarded.

In *exophthalmic* goitre the outlook is by no means as gloomy as many of the authors would have us believe. The enlarged thyroid gland can be treated as indicated above. Faradization of the vagus if the heart-beat is weak, galvanization of the vagus if the heart is irregular, are useful. To control a tumultuous heart, vibration in the interscapular

region and tapotement over the precordial space can be administered. High-frequency applications along the spine and over the temples and the forehead may be administered to restore the nervous equilibrium. Positive static insulation is useful in many cases. Positive head spray has a tendency to relieve vascular pressure in the eyes. Pressure over occipital region has a fine effect in cases of pain in the head and in the eyes. The general health of the patient should not be lost sight of. Many nervous symptoms in these cases are the result of auto-intoxication from the intestinal canal. Sun-baths are excellent in these cases. (See FUNCTIONAL DISORDERS.)

Gonorrhoea is the type of a self-limited disease with a well-marked tendency towards recovery, if not meddled with. There is no doubt that most cases of protracted specific urethritis, chronic gonorrhoea, gleet, etc., are due to misapplied methods of treatment. The inflamed mucosa should be left severely alone. In the latter stages of the disease, when the discharge has practically ceased, clear, warm water should be used by way of injection or irrigation. During an attack of gonorrhoea the patient should abstain from all alcohol, tobacco, meat, eggs, coffee and tea. He should be encouraged to drink water frequently and copiously. He should observe absolute cleanliness about his person. Immersion of the penis in very hot or cold water will usually relieve local irritation or pain. The diet should be continued for one or two weeks after the discharge has ceased. Colon-irrigation, hot sitz-baths and general elimination through the skin are indicated throughout the course of the disease. After the acute stage the high-frequency current and mild vibration may be used over the pubes and perineum to stimulate healthy local reaction. In *chronic* gonorrhoea positive electrolysis (very mild) by means of a sound or high-frequency applications by means of a urethral vacuum electrode has been found serviceable. Gonorrhoeal rheumatism is referred to under the head of RHEUMATISM.

Gout.—The systemic treatment of a case of gout should be conducted along the lines indicated under the head of RHEUMATISM. Locally dry heat, massage, vibration and electricity as suggested under the same head are serviceable. The dietetic management is of the greatest importance. Johann Schroth gave his gouty patients dry bread to eat and clear water to drink. Locally he used hot moist compresses and applied massage to the contiguous territory. His results won for him an international reputation. In convalescent cases powerful derivation by packs applied to the feet or walking in the wet grass is beneficial. General and local vapor-baths are serviceable in many cases. The diet suggested under the head of RHEUMATISM must be faithfully adhered to for a long time. The static brush-discharge (wooden electrode) is a good local anodyne and can be given daily for fifteen minutes. Depletion by leeches is not infrequently necessary. Bier's stasis might be indicated in obdurate cases.

Granulated Eyelids.—Trachoma is best treated by slowly moving a copper-tip electrode (positive) over the affected surface for two or three minutes with a current-strength of two to four milliamperes. A sponge electrode (negative) is held in the patient's hand. Treatment can be given once or twice a week. Negative electrolysis, with needle in each granule, positive sponge-electrode in hand, is recommended by some. Finsen-rays (dermo-lamp) sometimes give relief (fifteen minutes every other day). A. C. Goyser everts the lid, secures it in position by adhesive strips, places a piece of sheet-lead with a suitable perforation in front of the face and makes X-ray exposures for five minutes every two or three days. After five or six treatments a reaction sets in, whereupon high-frequency treatments with a dull-pointed vacuum-electrode are given for three to five minutes every day or two for two or three weeks. It is important to protect the eyeball.

Headache.—Always a symptom. (See AUTO-INTOXICATION, DYSPEPSIA, REFLEX DISORDERS, FUNCTIONAL DISOR-

DEERS, etc.) Symptomatic relief can be obtained from pressure over back of neck and head, pressure over temples and forehead, massage of temples and forehead, suggestion of sleep, positive static crown-breeze. (See PAIN and NEURALGIA.)

Hemorrhage.--The treatment depends on the cause, character and location of the hemorrhage. If the site is accessible, pressure, heat, cold or ligation might be required. If the bleeding vessels are inaccessible, surgical interference might be necessary. The more common forms of hemorrhage encountered in general practice are:

EPISTAXIS.--In many instances epistaxis is a therapeutic measure adopted by nature to counteract intra-cranial congestion. If bleeding persists, apply copper-electrode to bleeding cavity (positive, ten to twenty milliamperes, five to fifteen minutes, negative sponge nape of neck.) Make patient sit up. Apply cold compresses to forehead, temples and back of neck. Cold applications to the nose and the introduction of small pieces of ice are proper. In mild cases let the patient lie down and join his hands over the occiput. Instruct him to breathe deeply and hold his breath as long as possible. In threatening cases apply a cold, moist pack to the lower extremities.

HEMORRHOIDAL BLEEDING.--Patient should be at rest, lying down with head and shoulders slightly elevated. If bleeding is profuse, improvise a hot vapor-bath from the feet to the stomach. Technique similar to that which is given under the head of FEVER. Hot applications to the lower extremities up to the iliac crest, frequently renewed, answer equally well. If the hemorrhage is slight the cold, moist pack from the feet to the umbilicus is better. A hot compress should be kept to the feet. The object of all these applications is to lessen the blood-pressure in the lungs by drawing the blood to the lower extremities. Cold compresses to the back of the neck and the chest are useful. Diet should consist of cold liquid food. Swallowing small particles of ice is very serviceable.

HEMATEMESIS.—Patient should be at rest in the horizontal position. Swallowing small pieces of ice is beneficial. Cold compress on the stomach, derivating pack to the lower extremities. The general regime does not differ from that in cases of hemoptysis.

CEREBRAL HEMORRHAGE (APOPLEXY).—Patient should be placed on his side to prevent the tongue and the secretions from dropping into his air-passages. Cold applications to the head and back of the neck should be made. Pressure over back of neck is useful. Decrease intra-cranial blood-pressure by derivating applications as indicated in the treatment of hemoptysis given above. Powerful derivation to the lower extremities and to the abdominal wall should be practiced as given in the chapter on THE THERAPEUTIC EFFECTS OF HEAT AND COLD. This can be accomplished by hot baths, dry-heat cylinder, packs, vapor-bath, etc., etc. The vapor-bath described under the head of FEVER is excellent as a cerebral depletent. The secondary object in all these depleting applications is to stimulate skin-activity whereby the proportion of liquids in the body is lessened and the absorptive activity of the organism is thus given a powerful impetus. There is no method of treatment in cases of cerebral hemorrhage, cerebral congestion, cerebral toxæmia, etc., and their concomitant symptoms (coma, violent headache, severe nervous phenomena, etc.) that equals in promptness and intensity of palliative and curative efficacy the "derivating" pack or bath whereby the blood mass is directed toward the lower portions of the body. It is universally applicable in all cases in which it is desirable to relieve the brain of pressure. This form of treatment comes first in point of usefulness in cases of cerebral hemorrhage and also in cases of typhoid coma. In the former, blood-pressure is reduced, bleeding stops and absorption of the clot begins. In the latter, the passive congestion is counteracted, the local toxæmia lessens and brain-function is re-established. Enemata should be frequently and cautiously given without moving the patient out of the horizontal position. Catheterize the patient

as soon as practicable. If the patient's face is red and congested leeches should be applied to the temples and venesection practiced.

The after-treatment consists in frequent general luke-warm sponge-baths and massage to keep the skin active. A weak galvanic current (one electrode on each mastoid process or positive pole moved over temples and forehead, negative pole in back of the neck) helps absorption. Paralyzed muscles should be faradized. Food should be principally non-nitrogenous and not solid. Static positive insulation is useful. It might be well to add that persons who are prone to suffer from congestion of the head (apoplectic tendency) can do nothing better than to increase the circulation in the lower extremities by frequently walking in the wet grass or fresh snow. (Kneipp.) It is a prophylactic of great virtue.

UTERINE HEMORRHAGE.—Therapeutic directions are given under the head of METRORRHAGIA. If uterine hemorrhage occurs post-partum, the employment of vigorous massage to force contraction of the uterine body is very essential. Faradization with a tolerably strong current (abdomen and cervix) is often very helpful.

INTESTINAL HEMORRHAGE.—In thin subjects make cold applications to the abdomen, hot applications to the lower extremities. In fat persons a cold, moist pack over the abdomen is preferable to the cold compress. The latter would not penetrate while the former would draw blood away from the intestines and assemble it in the abdominal wall. Absolute rest is imperative. In thin persons the galvanic current (positive abdomen, negative on back) can be used with benefit. In fat persons the faradic current might serve to contract muscular tissue and in this way counteract hemorrhage. It is wise to withhold liquids even if the patient complains of thirst. Coagulation is thus favored. A firm abdominal bandage is sometimes useful. All these directions can be advantageously employed in intestinal hemorrhage occurring as a complication of typhoid fever.

Hemorrhoids.—Regulate the patient's mode of living. Exclude meat, spices, salty, sour and highly seasoned food from the patient's diet. The latter should consist of wheat-bread (from the whole grain), rye-bread, Schrot-brot, Pumpnickel, green vegetables, raw fruit, cider, fruit-jam, buttermilk. Fresh water at every meal. Irrigation of the colon carefully performed is valuable. The patient should avoid tight-fitting clothes (corsets, etc.) Massage of the stomach and bowels, Swedish movements to exercise the abdominal muscles, horseback exercise, mountain-climbing, gardening, are indicated. Hot sitz-baths, vapor-baths, abdominal hot pack, hot foot-bath before retiring, are very serviceable. Locally galvanism (positive copper-electrode to pile, negative to abdomen, ten to twenty milliamperes for five to fifteen minutes every day or two). Hard external piles should be treated with needle (negative electrolysis), hemorrhoidal varix with positive electrolysis. (See VARIX.) Vibration by means of a rectal attachment sometimes is useful in irritable hemorrhoids which are intact. Vibration over lumbar region, perineum and abdomen relieves congestion. High-frequency applications by means of a rectal vacuum electrode answer well in some cases.

Hepatic Cancer.—Treatment is purely symptomatic. Therapeutic suggestions are given under the head of HEPATIC CIRRHOSIS, DYSPEPSIA, GASTRIC CANCER.

Hepatic Cirrhosis.—The enforcement of the Schroth diet (stale bread, rice, oatmeal in small quantities, but little liquids, no alcohol) and the dehydration-method of Oertel (see VALVULAR DISEASES OF THE HEART) hold out fairly good prospects in the first stages of the disease. Cold moist packs on the abdomen, vibration and massage of the abdomen and daily irrigation of the colon are splendid adjuncts to the treatment. A large positive pad-electrode over the liver, negative to the feet and hydro-therapeutic applications to the lower extremities to unload the stagnant portal system, are valuable. The patient should avoid starches and fats. In the later stages of the disease the

treatment is purely symptomatic. Diet, derivating water-applications to the lower extremities, massage of the stomach, colon-irrigation, sun-baths and plenty of fresh air are the necessary conditions of treatment. Vibration of the liver is sometimes beneficial in the early stages of the disease, but injurious in the advanced stages.

Hydrocele.—Neiswanger recommends galvano-puncture (negative in scrotum, positive on abdomen, current gradually increased to forty milliamperes for five minutes). A different plan is to draw off the fluid, then inject one-third as much strong solution of KI, introduce large needle connected with positive pole, negative pole on abdomen, ten minutes, galvanism gradually increasing until fifteen to twenty milliamperes are reached.

Hypochondriasis is a disorder of the nervous system produced by disturbances of alimentary function and is mostly found in men. It is closely allied to the hysteria of the female. (See FUNCTIONAL DISORDERS, REFLEX DISORDERS, DYSPEPSIA, NEURASTHENIA.)

Hysteria may be defined "a condition of the nervous system of women, characterized by a suspension or impairment of initiative will-power and by the dominant influence of imagination or emotion over the sensory and motor functions." It corresponds to the hypochondriasis of men. The etymology of the word "hysteria" points to the sexual organs as the primary seat of the disorder, while the term "hypochondriasis" suggests the digestive organs. The literal meaning of the two words shows the wisdom of the ancients whose primitive notions concerning etiology and pathology have in not a few instances outlived the many upheavals in medical lore that have marked the history of the healing art. In treating functional diseases of the nervous system, always look to the sexual organs first and to the stomach second if the patient be a woman. In a man reverse the order named and think of the stomach first and then of the sexual apparatus. Woman is more a creature of sex than man. The manifestations of both hysteria and

hypochondriasis are probably symptoms of auto-intoxication. (See FUNCTIONAL DISORDERS, REFLEX DISORDERS, DYSPEPSIA, NEURASTHENIA.)

Try to find out the cause and remove it, if such is possible. Let the environments of the patient be ideally hygienic (sunlight, fresh air) and give due attention to the four emunctories. Suggestion is a most powerful agent for good in the management of a case of hysteria. It should be given through the mind of the patient by the presence and by the moral and personal influence of the physician. The patient's surroundings should, through the special senses, serve to accentuate the suggestion. Everything should be done to rouse and fortify the patient's will-power without hurting, frightening or shaming her. The patient should be removed from the presence of people and from their meddlesome influence. Sometimes a patient will have to be put to bed. Weir Mitchell's plan of isolation, massage, faradism and forced feeding (Mastkur) has but little to recommend it.

Massage of the stomach and abdomen is very beneficial in most cases. It can be combined with rapid and light vibration of the whole spine, especially the dorsal and lumbar regions. If the patient is anemic, general massage and a daily protracted sun-bath can be given. If the case presents violent symptoms, the positive static spray along the spine will be found very serviceable. If the patient inclines toward introspection and melancholia, the negative static spray or the negative static insulation are indicated. If the patient's condition is associated with menstrual disturbances or sexual aberrations, vibration or firm pressure over the ovaries sometimes gives relief. In many cases Swedish movements are followed by improvement. Forcibly raising and rotating the arms and legs in the standing or lying posture serves to deplete the body toward the periphery. Eventually these movements can be executed with an attendant resisting. Warm applications over the abdomen, while a cold moist pack is applied to the lower extremities,

is frequently of service. Cold douches over the spine and over the lower extremities are useful. In some cases of paresis warm baths (carrying a mild faradic current) have a good effect. Hysterical paralyses require suggestion, locally vibration, faradization and massage. The high-frequency current applied by means of a vacuum-tube is a splendid adjunct, especially in aphonia and dysphagia. The diet of a patient should be vegetable for well-nourished individuals, nitrogenous for frail and anemic subjects.

Hysteria is distinctly the disorder of an individual nervous system. It is impossible to treat a case of this kind without painstaking individualization. There is no disease where so much depends on the personal equation of the physician as in hysteria. Suggestion is by all odds the foremost therapeutic agent. It should be practiced persistently in these cases. Hysteria offers a fruitful field for studies in animal magnetism. The "laying on of hands" as practiced by Charcot, Bernheim and Fuchs has demonstrated the clinical possibilities of animal magnetism in cases of hysteria and allied disorders. Under the head of *LOCOMOTOR ATAXIA* the movement-cure of Fränkel is discussed. The patient who has lost co-ordination is taught to perform certain muscular acts mechanically. The suggestive therapy in hysteria is analogous. It educates a mind whose co-ordinative power has been lost, to functionate in a sort of mechanical way in keeping with certain suggestions. If there are remediable features about the case, they should be met by suitable means. In young girls mental hygiene and regulation of the menstrual function should be the object of treatment. A love-hungry old maid who has become hysterical should be married off to re-establish the balance. In hysterical widows the regime is similar. If a married woman is denied the privilege of motherhood, the case can often be cured by directing the misspent energy into proper channels. Such a woman should find an object in life to take the place of a child of her own flesh and blood. Let her adopt a child. The principal thing is to find an object

to act as a constant source of suggestion to a hysterical subject. Interest her, arouse latent ambition. Stimulate force and let her spend it. Therein lies the psychology of Women's Rights Associations, Temperance Societies, etc. Sociologically they might be a nuisance, therapeutically they serve an admirable purpose in many cases.

Incontinence of Urine.—Cold douches to the spine, vibration over the lumbar vertebræ and regular evacuation of the bowels are helpful. Mild vibration over perineum in boys is advised by some, but seems of doubtful efficiency (might cause greater evils). Galvanism (ten milliamperes, positive over pubes and spine by means of a bifurcated electrode, negative to feet) or faradism (lumbar region and pubes) are recommended by some. Static spray (positive) over sacral and pubic regions might be tried. Try foot-baths containing negative pole and warm wet pad around pelvis, connected positively, mild galvanic current every day. Local causes should be inquired into, also condition of general health. (See HYSTERIA and FUNCTIONAL DISORDERS.)

Inflammation (Acute).—The amount of blood which is carried to any part is regulated by the vaso-motor (sympathetic) nerves in keeping with the physiological needs of the part. Increased need calls for increased blood-supply (physiological hyperemia). Increased need may be brought about by increased activity (function) of the part or by the presence of some element by which the integrity of the part as such is endangered (trauma, septic matter, etc.) To protect the part, an enormous increase in the arterial supply takes place. This means over-nutrition, more active local metabolism and oxidation. Incidentally nature isolates the part by surrounding it with a wall made up of congested blood-vessels, lymphatics and infiltrated connective tissue. In this way the system at large is protected against invasion. Locally, there is heat, pain and swelling. If the affected part is near the surface, the skin will appear red. Vaso-motor control is lost and changes occur

in the contents of the blood-vessels (exudation of serum, transmigration of white blood corpuscles), and new cell-formation outside of the vessels takes place. This composite local process is called inflammation. Eventually vaso-motor control reasserts itself, absorption takes place and the normal condition again supervenes. If the resisting power of the part is not equal to the ordeal of so severe a local reaction, the part may die molecularly or *en masse*. Thus, inflammation may terminate in ulcer or sloughing. If pus-germs are present, the inflammation may merge into an abscess (localized suppuration). The agencies which may cause a part to become inflamed are: vicious systemic conditions, irritation by intense heat or cold, infection by germs, destruction of tissue by injuries of any kind. The system at large may co-operate with the affected part by intensifying general metabolism. In this way a (local) inflammation may cause a (general) fever. Biologically speaking, both inflammation and fever are restorative agents. In this sense we may say that inflammation is to a part what fever is to the general system.

There are certain therapeutic principles which hold good in all cases of inflammation. Clinically we may recognize three stages of inflammation, to wit: congestion, exudation and restoration (absorption).

CONGESTION.—During this stage our efforts should be directed towards aborting inflammation by dispersing the blood-mass. The older physicians practiced depletion by venesection. The same result without loss of blood can be achieved by hydro-therapeutic methods (derivation). If the congested area is accessible, practice massage (effleurage centripetal) on the healthy tissues near the periphery of the inflamed portion in order to stimulate absorption. The fundamental therapeutic principle during congestion in any part of the body is: Deplete the region by causing the blood to be drawn to some distant part. The *modus operandi* is exhaustively discussed under the head of HYDROTHERAPY.

The local treatment of the congested part is of great clinical significance. Cupping and the use of leeches are depletent measures. The ice-bag is a much abused because ill-understood measure. If the inflamed part is near or at the surface and, therefore, easily reached by thermic influences, the continuous application of ice can never be proper, *e. g.* during the congestive stage of appendicitis in a tolerably thin patient. To freeze the part means to suspend all evidences of vitality. Blood-vessels are contracted, the skin becomes inactive, the local temperature drops below the point of health. Even granting that in this way the inflammation has been literally frozen out, is it possible for the part to recover without some damage having been done to its functional tone (nutrition)? The vaso-motor nerves are irreparably damaged by the devitalizing effect of intense cold. The part is bound to lose some of its resisting power and congestion and inflammation are more than likely to recur. With the local physiological tone below par, pus-germs have a splendid soil for development. The continuous application of ice lessens the resisting power of the part, favors recurrence of local circulatory disturbance and facilitates suppuration. This is well shown by the clinical history of not a few cases of appendicitis. The direct action of intense cold on an inflamed part is not conducive to restoration without damage. The more healthy tissue intervenes between the ice-bag and the inflamed area, the less objection there is on this score. In a fat patient suffering from congestion in the right iliac space, the application of ice is less objectionable than it would be in a thin person. The same may be said of the use of the ice-bag on the head and on the chest. The calvarium and thorax neutralize by their interposition the objectionable feature of the intense cold. In inflamed joints the continued application of ice is often directly responsible for disastrous results. This holds good more especially in children.

Priessnitz was in the habit of causing cold water to

flow over territory contiguous to the inflamed area. In this way stimulation of the surrounding tissues was produced and a mild depletent action followed. Moderate heat (like the heat of a poultice) or moderate cold (like the temperature of well-water) are therapeutically available. Both are stimulants, the cold application more so than the warm. In choosing between them the comfort of the patient should be consulted. Whichever application gives relief should be chosen. Ordinarily the hot application does well in cases where the inflammatory action is not cutaneous. The more superficial the inflammation, the lower should be the temperature of the application. It should, however, never be the temperature of ice or ice-water. The indications for massage and vibration increase in proportion to the distance of the inflamed area from the skin. It should be remembered that the greatest benefit is derived from manipulation of the contiguous tissues. For obvious reasons intense heat (dry-heat cylinder) is available for the purpose of depleting deep structures by drawing blood to the surface and stimulating the latter. In this way its action would be analogous to the *modus operandi* of a hot poultice. Fine therapeutic effects can at times be produced by modifying the application of the principle of derivation with the aid of the dry-heat cylinder. Deplete a congested area by baking a neighboring part, *e. g.* by giving a dry-heat treatment to the femoral region and knee for the purpose of relieving a cellulitis in the foot. Exposure to the Minin light has a depletent effect if the inflammation is comparatively deep-seated. The physiological principles involved are plain.

If the inflamed region is comparatively superficial and not very extensive, good effects can often be produced by placing a (positive) sponge-electrode directly over it (negative pole at some distance) and allowing a mild galvanic current to pass through it. A positive static spray is very serviceable.

EXUDATION.—When the second stage of inflammation

has begun, it is no longer possible to abort the process by depletion. On the contrary, the condition is one of stasis. The blood is partially disintegrated by exudation of some of its aqueous elements and a loss of some of its corpuscular constituents. During this stage pressure or massage is useful if the part is accessible, the object being to stimulate the absorbent vessels. Alternate applications of heat and cold are a powerful alterative. Pressure may be accomplished by a bandage, adhesive strips, by bags of sand or shot. Massage and vibration of the surrounding parts, especially between the inflamed area and the heart, are very useful. It stands to reason that in inaccessible inflammations (meningitis, pneumonia, etc.) these direct therapeutic methods are not applicable, although much good can be done by increasing metabolism in distant parts or in the whole system. (See PNEUMONIA.) Ordinarily, warm applications are best adapted in the second stage of inflammation.

The faradic current can be employed during the second stage of inflammation. It contracts muscular tissues and in this way can be made to compress an inflamed part. The high-frequency current has been known to shorten the stage of exudation and hasten absorption. Good effects can often be produced by placing the inflamed part between the poles of a galvanic circuit. The applications should be mild, short and frequent. Polarity should be reversed with each succeeding application.

ABSORPTION, SUPPURATION, SLOUGHING.—Restoration in favorable cases takes place by absorption. Hydro-therapy again offers the best means of intensifying and accelerating the last stage of inflammation. General derivation (complete cold moist pack) is indicated if the inflammatory area has any extent at all. In accessible cases massage and vibration along the lymphatics centripetally are valuable, especially if the affected area is in the arm or leg. Central vibratory stimulation to promote absorption is useful as an adjunct to local massage. If the symptoms of inflamma-

tory reaction persist, especially pain, the formation of pus may be looked for. (See SEPSIS.) The result may be more or less disintegration of tissue. (See ULCER.) In addition to the surgical rules which must prevail in these cases (incision, evacuation, surgical cleanliness), the circulation in the affected area and in the contiguous structures should be stimulated by suitable means. In the treatment of the extremities the virtues of the continuous immersion in (flowing) hot water can not be too highly spoken of.

SYSTEMIC CONSIDERATIONS.—Fever is the most conspicuous evidence of the part which the system at large plays in conjunction with a local inflammatory condition. (See FEVER.) The diet in these cases should be bland, easily digested and non-stimulating. (See DIET IN ACUTE FEVERS.) Even if the local inflammatory condition involves important internal structures of vital significance in the economy, a starvation diet will often help to shorten the inflammation and hasten the absorption. Keep the patient's bowels open and restrict the patient to dry bread or crackers, with a little fruit-juice. Give but little water. If the patient is weak, add a little light wine to the water. A diet of this kind for two or three days makes a deep impression on metabolism. The system is compelled to force absorption. Thus the inflammatory process is shortened and its severity lessened. If the inflammation is the result of a systemic disorder, the latter should receive proper attention.

Inflammation (Chronic).—If, for some reason or other, an acute inflammation has not terminated in absorption, suppuration or sloughing, but continues in a mild degree, the condition is called *chronic* inflammation. It is characterized by passive congestion, thickening or hardening of the tissues and a liability to acute exacerbations. Eventually changes occur in the structure of the tissue, owing to the altered conditions of nutrition. The most characteristic sign of a chronic inflammation is the absence of a restorative tendency. The part affected apparently remains

in statu quo. There is no resisting power in the affected region. Acute symptoms are likely to arise at any time. The structural changes may consist in the formation of cicatricial tissue, firm adhesions, thickening of membranes, proliferation of connective or other forms of low tissue, organization of exudates, etc. There may be complete suspension of function owing to atrophy or destruction of the functioning elements, exaggerated or perverted function. At times the chronic inflammation begins and continues as such. The word "catarrh," which in the minds of the public has a well-established significance, refers to these conditions. They may be the local expression of a deteriorated state of the system, acquired or inherited. They may be due to long-continued irritation of the part. This irritation might be due to the mistreatment of an acute inflammation. The catarrhal conditions in the right iliac fossa which are essentially chronic and after a number of acute exacerbations might become the culture-soil of pus-germs, are illustrative of a class of cases that are not infrequently produced by the wrong kind of therapeutics, *e. g.* the continuous use of the ice-bag. The catarrhal conditions in and near the uterus are the products of abuse (irritating vaginal douches, cold douches, sexual errors, etc.), causing changes in the circulation and nutrition of the part. That, under these conditions, latent embryonic cells might be stimulated and developed, leading to malignant formations, there seems to be no reasonable doubt. That this is the etiology of uterine cancer seems to be more than plausible. Chronic inflammation or catarrh may gradually give rise to atrophy, hypertrophy, degeneration of diverse kinds, hyperplasia, ulceration, cicatrization, exudation, suppuration and may be associated with any number of intercurrent affections.

From a clinical point of view chronic inflammations or catarrhal conditions might be divided into those which involve inaccessible, and those which affect accessible parts. In the latter the local treatment would necessarily be an element of great therapeutic importance.

In cases of inaccessible chronic inflammations hydrotherapy enables us to control, alter, increase or decrease the circulation in and near the affected region ("derivation"). The possibilities of water-applications are well-nigh unlimited. In all cases of chronic inflammations or catarrhal conditions, irrespective of their location, duration, extent or severity, elimination through the skin should be the beginning of all rational therapy. A local circulatory disturbance can not exist for any length of time without involving the system generally. Sluggish circulation in the affected part disturbs the local metabolism. Retained waste, effete matter and combustion-products gradually are absorbed from the chronically congested area into the general system, giving rise to the thousand and one possible forms of auto-intoxication in variable degrees of severity. Thus we get the typical picture of a chronic ailment, local in its pathology but constitutional in its symptomatic expressions. Not infrequently the general symptoms detract from the local disturbance. Through the sympathetic nervous system whose fibers and ganglia are irritated by absorbed toxic material, an unending variety of symptoms might be produced. (See FUNCTIONAL DISORDERS and REFLEX DISORDERS.) Chronic inflammatory conditions of the gastric, intestinal or bronchial mucous membrane, of the pelvic cellular tissue, of the Schneiderian and pharyngeal membranes, of the ovarian tissues, of the connective and fibrous tissue in the muscles of the back are in this way responsible for any number or variety of toxemic symptoms, erroneously called reflex symptoms. The term "reflex symptom" is a much-abused mantle of charity which covers a multitude of diagnostic inaccuracies. Reflex symptoms, *e. g.* headache, neuralgia, vertigo, palpitation of the heart, malaise, irritability, etc., etc., are usually evidences of auto-intoxication and require general eliminative treatment. This is most emphatically proper in cases where an acquired or inherited vicious condition of the system prevails. In all chronic conditions the first step in the treatment should be

to open the avenues of excretion. Colon-irrigation should be practiced twice or three times a week. The skin should be kept active by general packs, dry-heat baths, vapor-baths, etc. On general principles it might be stated that in most chronic conditions excretion is sluggish and reaction imperfect. Therefore, the hot applications (dry-heat cylinder, vapor-bath) are preferable to the more exacting cold moist packs. The latter are to be substituted after the system has become habituated to active metabolism. General massage should be added to all general treatments outlined above. Dietetic directions should be given in keeping with the physiological requirements of the individual case. Afebrile conditions require a preponderance of carbohydrates (bread, Graham-bread, Schrotbrot, crackers, rice, oatmeal, zwieback, milk-toast, fresh fish, oysters, potatoes, fresh fruit and vegetables, with the exception of peas, beans and lentils). The idiosyncrasies of the patient and individuality of the patient's stomach should be considered. Fresh water is always proper. Weak coffee and tea are permissible; alcoholic stimulants are contra-indicated in most cases.

In view of the vast importance of air and light on metabolism, exercise in the open air and exposure to sunlight should be insisted upon. No sanitarium for the treatment of chronic diseases is complete without a solarium.

Electricity is a splendid helpmate in the general treatment of chronic inflammatory conditions, the object of electrical applications being to aid in general innervation and help in the restoration of metabolic activity. General faradization is proper in cases of muscular asthenia. General galvanization answers well in cases of sluggish lymph-circulation and inactive skin. Both currents can be administered by means of a water-bath which carries one pole while the other pole is applied to some portion of the patient's skin (out of the water). Static applications are useful (potential alternation, insulation). Last but by no means least, general high-frequency applications are ca-

pable of producing splendid effects on metabolism (D'Arsonval's cage, diasolenic cylinder).

To improve the tone of the vegetative functions of the organism, vibratory stimulation (mild rapid strokes, three to five minutes daily) along the sixth to the twelfth dorsal vertebræ on either side of the median line should be practiced. Manual manipulations may be given with the patient lying on the right, patient's left arm raised up, his hand resting on left side of his head. The operator should stand on the side of the table toward which the patient's face is directed, pass his left hand over the patient's shoulder, his right hand over lower ribs of patient, until his fingers rest on the left side of the spine between the sixth and twelfth dorsal vertebræ. With his fingers firmly placed on the line described, the muscles of the spine should be drawn upward, downward and outward successively by regular movements of the operator's hands. Let the patient turn over on his left side with his right arm, operator facing the patient for treatment of the muscles on the right side of the median line. This mode of manipulation is an excellent stimulant for the general metabolic functions through the splanchnic nerves and may be followed by vibration, as indicated above.

The therapeutic directions given comprise the general treatment of chronic inflammatory or catarrhal states. They should be applied, singly or in combination, with due regard to the peculiarities of the individual patient. The object of general treatment is to improve the system at large and incidentally remove the evidences of auto-intoxication (reflex symptoms). General treatment is indicated in all chronic catarrhal conditions. If the seat of the trouble is directly accessible, *e. g.* in many diseases of women, the local treatment is equally important. Since the local management of a catarrhal state depends upon many incidental contingencies, it is necessary to discuss the details thereof separately under the head of special conditions.

Inoperable Malignant Disease.—The uses of the X-rays and Finsen-rays in the treatment of cancer have

been referred to in the chapters on X-RAY THERAPY and PHOTO-THERAPY. Many cases of cancer, especially those who are suffering from an inoperable variety of malignant disease, should be given the benefit of a form of electrotherapeutic treatment, which is by no means as well known and as extensively employed as it deserves to be, to wit: cataphoresis. The rationale and technique as well as the practical results achievable are sufficiently well-established to justify the classification of cataphoresis as one of the foremost of non-surgical therapeutic methods in the treatment of cancer and surely in inoperable cases the most available. It is the one method that holds out hope after all else has failed and has the great advantage of being comparatively a mild and simple procedure.

Cataphoresis by means of zinc-mercury electrodes for the destruction of cancer-cells consists in the diffusion through the tissues of nascent salts of zinc and mercury, which are the products of the chemical action taking place when the fluids of the body act upon the metallic substances of the electrode. The products of this electrolytic process invade the tissues in all directions from the point of application, combining with the albumen of the tissues and forming albuminates of zinc and mercury. Cancer-cells have but little resisting power and rapidly break down. Normal cell-elements, having a higher degree of resisting power, withstand the action of these destructive agents. The range of activity of the latter is marked during the first forty-eight hours by a reddened and puffy area, which G. Betton Massey, who is the champion of this method, designates as the "zone of sterilization." Granger speaks of the selective and detective action of the zinc and mercury salts, which seem to follow up and ferret out the proliferations of the malignant tissue much more perfectly than the knife of the surgeon or the Roentgen rays do or can.

The technique of this form of cataphoresis is simple and can be modified to suit the indications of any kind of a suitable case and the varying ideas of different operators.

Short applications frequently repeated with a current-strength of thirty to fifty milliamperes might be made, or the cataphoric destruction may be accomplished in one sitting with the patient under the influence of an anesthetic, five hundred and more milliamperes being employed. The application can be made by a suitably shaped electrode which is placed on the surface, or by means of pointed electrodes introduced in one or more places into the very substance of the growth. The tip of the electrode is a zinc-mercury amalgam. The electrode must be connected positively. The application is continued until the discoloration of the surrounding tissues indicates that the local reaction is complete. Eventually the diseased tissue will break down and be discharged. The remaining cavity or ulcer is supposed to be healthy and heals accordingly. It is understood that cleanliness and attention to surgical details should not be lost sight of. The method has been used in all kinds of sarcomatous and carcinomatous diseases, especially those which were inoperable. In rodent ulcer, indolent ulcers, etc., the method has been employed with much success. The late Dr. Gaston, of Atlanta, advocated the cataphoric introduction of Donovan's solution (liquor hydrargyri et arsenii iodidi) in the treatment of malignant growths and ulcers. The method was used in a case of inoperable sarcoma of the abdominal wall, the ultimate outcome of the case being a perfect cure.

Zinc-mercury cataphoresis has been used in cases of malignant disease of the breast, tongue, upper maxilla, glands of neck, rectum, uterus, face, pelvic bones, coccyx, etc.

A mild form of metallic cataphoresis is the use of a mercury-covered electrode. It produces alterant and solvent effects and has been employed successfully in cases of pelvic adhesions. The use of a zinc electrode is indicated in tubercular glands and in all conditions requiring a powerful local germicidal reaction.

The dietetic aspect of the cancer-problem is of some in-

terest. That the use of meat has some connection with the etiology of cancer, seems certain. Cancer cases are more frequent in the United States than anywhere on earth. It is a well-known fact that there is more meat consumed by the American people than by any other nation or race. In China cancer is comparatively rare. Among the (fruit-eating) natives of the East Indies cancer is unknown (Darwin). There seems to be no doubt that the increasing prevalence of cancer suggests a physical degeneration of the race.

All cancer-cases should be given the benefit of invigorating general treatment (static electricity to improve the nervous system, dry-heat cylinder to promote excretion, colon-irrigation to improve bowel-function).

Insomnia.—Find the cause. Symptomatic relief might be obtained from positive static head-breeze, galvanism (positive to head, negative to spine) galvanic bath (negative in water, positive to back of neck), effleurage over forehead and suggestion of sleep, irrigation of colon, hot application to abdomen, firm pressure over nape of neck to induce cerebral anemia, hot foot-bath, vibration over cervical vertebræ and centrifugally along the arms and legs, a cold moist pack from the feet to the neck, a short hot bath, a protracted warm bath or a general dry-heat treatment. Select the proper regime in keeping with the cause of the sleeplessness.

Intra-pelvic Inflammations.—The term has reference to the numerous inflammatory conditions which may prevail in the female pelvis, involving the uterus, the tubes, the ovaries and the connective and peritoneal tissue closely related to the intra-pelvic organs. We may encounter acute, subacute and chronic inflammations of the uterus (metritis), tubes (salpingitis), ovaries (ovaritis), of the connective tissue around the uterus (para-metritis) or in the pelvis at large (pelvic cellulitis), of the serous covering of the internal genitalia (peri-metritis, pelvic peritonitis) in various degrees of severity and due to a variety of causes. The eti-

ology of the inflammatory state should carefully be considered in adopting a therapeutic regime. Sexual hygiene should be enforced in all these cases, (1) by cleanliness (vaginal douches and warm ablutions), (2) regulation of cohabitation, and (3) in certain cases by attention to the functions of the bladder and rectum (catheterization, rectal injections).

ACUTE INFLAMMATIONS.—Rest is the first and most important therapeutic factor. The general management does not differ from the regime which is indicated in all acute inflammatory conditions. (See **INFLAMMATION.**) Diet and hydro-therapeutic measures are probably the most essential therapeutic agents in the treatment of inflammatory affection in the female pelvis. The same holds good in regard to subacute conditions, especially if pain is a pronounced symptom.

CHRONIC INFLAMMATIONS.—The broad features of treatment are suggested in the discussion of catarrhal conditions generally. (See **INFLAMMATION, CHRONIC.**) In the individual case the local treatment will depend on many accidental features. There may be a low form of inflammation involving the tissue of the cervix or uterus and associated with considerable enlargement of the affected portions owing to proliferation of connective tissue (hyperplasia). The catarrhal surface may be engorged and may bleed easily. It may be broken down in places, giving rise to ulcers and granulation. The catarrhal state may involve some of the connective or peritoneal tissue. There may be foci of inflammatory reaction that nature attempted to repair in the presence of abnormal nutritional and functional conditions, the result being the formation of cicatricial tissue. The latter may have caused neighboring parts to be dragged out of their normal position, *e. g.* the uterus. Inflammatory exudates, instead of being absorbed, may continue to exist in a more or less advanced state of organization, causing changes in the relation of the pelvic contents or giving rise to pain, disturbed defecation and mic-

turition, various disorders by pressure on special structures (nerves, rectum, bladder, etc.). Then there may be the thousand and one symptoms produced by reflex irritation of the nervous system or by absorption of toxic material from the sluggish venous and lymphatic circulation in the pelvis. In all these conditions the object of the treatment should be to stimulate metabolism in the affected region, to tone up innervation, to restore normal relation by breaking up adhesions and forcing the absorption of exudates. (See PELVIC ADHESIONS AND EXUDATES.) Many of these cases present purely surgical problems, but by no means as frequently as the gynecologist of to-day would lead us to believe. Operative treatment in many of these cases is unnecessary and not infrequently useless. Physiotherapy has established a conservative system of gynecology for which the world is indebted in no small measure to the genius and resourcefulness of the American physiotheraputists.

In order to stimulate metabolism in the pelvis, and in this way to help in the absorption of exudates, extravasations and effusions, depleting applications to the external parts and to the abdomen are useful. Some gynecologists, notably G. M. Blech, have championed the local use of light as a substitute for hydro-therapeutic applications. The treatment is given by means of a specially constructed chair, which is provided with incandescent lamps. Powerful stimulation of skin function primarily and metabolism secondarily follows the application, the effect being partly due to the action of the thermic rays, partly to that of the luminous rays. A treatment lasting fifteen to thirty minutes may be administered daily. It is advantageously followed by a vaginal high-frequency application for ten minutes. In this way the reaction is intensified, not to speak of the disinfectant action of the high-frequency radiations.

The galvanic current is adapted to these cases in a variety of ways. In applying it we must bear in mind that

the positive pole attracts oxygen and contracts the blood-vessels. It temporarily increases local oxidation, but lessens the actual amount of blood which is carried to the part. In intensifying oxidation it stimulates the lymphatics and promotes absorption. By contracting the vessels it forces the veins to evacuate their contents and regenerates the quality of the nutriment which is carried to the part. Ordinarily an application (five to twenty milliamperes) should last from ten to twenty minutes to produce these effects. It can be repeated once every other day. The negative pole can be put in a convenient place near by. The abdominal wall is a splendid place of application for the negative pole by means of a flat pad-electrode. In all conditions in which it is desirable to intensify the change of tissue-elements locally and thus to help in a physiological regeneration of the affected part, the positive pole should be used as the active pole. It should be brought as close to the affected portion as possible by means of a suitable (vaginal, uterine) electrode. The styptic action of the positive pole makes it ideally available in treating surfaces that are congested and have a tendency to bleed.

After pathological changes have taken place, the constructive effect of the positive pole must be supplanted by the destructive action of the negative pole, especially in chronic inflammatory conditions of the mucous membranes, attended by hyperplasia, thickening and hardening of the underlying tissues. The dehydrating action of the negative pole causes disintegration of the morbid tissue and gives a powerful impetus to the process of repair by the reaction which follows, and resembles a mild type of an obliterative inflammation. The positive pole is placed on the back or on the abdomen, the negative pole being applied directly to the affected surface or part by a suitable instrument. The effect can be enhanced by wrapping moist cotton or chamois around the tip of the electrode. A current of from five to fifteen milliamperes can be advantageously employed for five to ten minutes every two or three days, depending on

the degree of reaction which is desired in the individual case.

In cases where a germicidal effect together with an astringent action is desired, the use of a copper electrode with the positive pole (cupric electrolysis) is of advantage. The affinity of the positive current for oxygen causes the latter to combine with the copper, forming an oxide of copper. The sodium chloride contained in the blood is decomposed, the free H Cl combining with the copper oxide, the result of the combination being oxy-chloride of copper, which has strongly germicidal and astringent properties. It is even carried into the deeper tissues by cathodic action and can be advantageously employed in many infective (purulent) conditions of the pelvic contents. Chronic suppuration in the pelvis (*e. g.* in one or both Fallopian tubes) may follow an acute infective process. After the acute stage has passed, the purulent fluid loses its specific infective character and becomes more or less innocuous. The pus-germs cease to be active. In cases of this kind conservative electro-therapeutic treatment in conjunction with other means to promote local metabolism leads to absorption and excretion of the fluid, leaving a healthy, dry cavity behind. In addition to the therapeutic measures mentioned, galvanization of the pelvis (one electrode in a sitz-bath, the other on the back, poles frequently reversed) is a local alterant of great virtue. A similar action can be produced by using a douche as a conductor. (See LEUCORRHEA.)

To restore the muscular tone of the pelvis, faradization is an agent of unquestioned value. It can be administered by means of a suitable vaginal or uterine electrode or by the hand of the operator, who holds one sponge-electrode in the unengaged hand while the other electrode is placed on the patient's abdomen or held in her hand. Faradization by means of a local or general bath is likewise useful.

Additional points of interest pertaining to the treatment of these chronic diseases of women are contained in the

discussion of a number of special subjects. (See ENDOMETRITIS, PERITONITIS, PELVIC ADHESIONS AND EXUDATES.)

Jaundice (Catarrhal).—The diet of the patient should consist of carbo-hydrates principally (fats and starches excluded), fresh fruit, soups, olive-oil and plenty of water. Highly seasoned foods, spices, sweet or sour foods, should be avoided. Colon irrigation, hot applications to the liver, "derivating" packs to the lower extremities, galvanism (positive pad-electrode over right hypochondrium, negative over lumbar region), vibration and high-frequency currents over spine and general sun-baths, are valuable auxiliaries. The hot vapor-bath or dry-heat cylinder should be used once or twice weekly to stimulate skin-elimination. The regime outlined is applicable in all congestive conditions of the liver.

Lateral Sclerosis.—The therapeutic regime does not differ from that which is resorted to in cases of degeneration of the posterior columns. (See LOCOMOTOR ATAXIA.)

Leucorrhœa.—Catarrhal conditions of the vaginal, cervical or uterine mucous membrane require local cleanliness (warm douches) daily. Applications of a high-frequency current by means of a suitable vaginal glass-electrode are of advantage. Local vapor-baths (sitting over a vessel containing very hot water) or local exposure to light, as recommended by G. M. Blech, once daily, has an alterant effect and helps to correct the local circulation. To counteract passive congestion of the vaginal mucosa, introduce a positive vaginal copper electrode, negative pad-electrode on abdomen, twenty milliamperes for ten minutes every other day. Some wrap a wet cloth or wet cotton around the vaginal electrode. Intra-uterine applications are made in the same manner, care being taken to loosen the electrode by reversing the current. The use of an aluminium or nickel vaginal electrode connected negatively, the positive pad-electrode on the abdomen is sometimes advantageous. Duration, dosage and frequency as above. This application is contra-indicated, if parts are hyperæsthetic. Bennett

recommends the so-called hydro-electric douches by means of a syringe, the tip of which carries a copper wire and thus allows an electric current to pass through the water over the affected area. Technique as before. For other local and general measures see INFLAMMATION (CHRONIC). Coition should be avoided, especially in vaginal leucorrhœa. Deep vibration from last dorsal vertebræ down to coccyx, and manipulation of the muscles of the region named, can be added to the treatment in cases where circulation is sluggish.

Liver-spots (Chloasma).—Negative electrolysis. (See FRECKLES.)

Locomotor Ataxia.—The impotence of drug-medication in the treatment of the slow but steady degeneration of the posterior columns of the spinal cord and of the posterior nerve-roots is admitted on all sides. On the other hand, it is a well-recognized fact that the physical and mechanical methods are capable, not only of relieving some of the disagreeable and distressing concomitant phenomena but influencing the course of the disease itself. The clinical picture presented by a typical case of tabes dorsalis is familiar. The disease presents three distinct phases. The first stage is marked by sensory disorders. During the second stage co-ordination is impaired and lost. During the last stage paralysis supervenes. Destruction of nerve-tissue is complete. Death closes the scene. The cause of the disease is obscure, although it is not unlikely that it is frequently a late manifestation of a syphilis acquired by an ancestor, not necessarily belonging to the preceding generation. It may be an atavistic appearance of lues or rather of a luetic taint. Syphilis is undoubtedly the predisposing cause, although the potency of exciting causes (excessive venery, sexual perversions, excesses of various kinds, etc.) must not be lost sight of. The four familiar pathognomonic symptoms of tabes dorsalis are (1) absence of the patellar reflex; (2) inability to remain in a firm erect posture with eyes closed; (3) loss of pupil reflex to light, but preserva-

tion of reaction to accommodation; (4) ability of the patient to fully extend his legs while lying on his back with knees drawn up.

The therapy of an incipient case of locomotor ataxia should begin with the enforcement of an absolutely perfect hygiene, physical and mental rest, fresh air and sunlight. If the stomach of the patient is in good condition, the patient can be fed to a liberal nitrogenous diet, care being taken that the bowels are kept open and that the stomach is not overtaxed. If the stomach is in poor condition, the course of the disease will be more rapid. The diet under these circumstances will have to be in keeping with the actually existing conditions. (See *DYSPEPSIA*.) It may be of interest to know that fish and oysters have always enjoyed a great reputation as parts of the *menu* of tabetic subjects. Alcohol and tobacco must positively be excluded. The general management of a case should include a general eliminative treatment in the thermic-cylinder or electric-light cabinet, followed after an hour's rest by general massage. A treatment of this kind should always be given twice a week. Its relative severity should be adapted to the tolerance of the individual patient. If other eliminative procedures are resorted to, the above general treatment must be given less often and modified to suit existing conditions. For the sake of classification and convenience, the available therapeutic methods are presented under special heads. The physician will have no difficulty in adapting therapeutic details to the requirements of the individual case.

MECHANO-THERAPY.—The tendency of modern thought seems to be in the direction of carefully regulated exercise for tabetic subjects from the hips up and the application of systematic massage from the hips down, and, for that matter, massage of the whole body every day. I can not quite agree with the idea of no exercise afoot, as J. K. Mitchell puts it. During the early stages of the disease, exercise on foot is inseparable from the enjoyment of fresh air, sun-

shine and mental hygiene (occupation of the patient's mind with pleasant objects). If exercise is well-regulated and not carried to the point of fatigue, it can not but be productive of much benefit. Kneipp sought to deplete the congested medulla by forcible derivation to the lower extremities. He made his tabetic patients walk barefooted in wet grass to get the benefit of exercise, derivation, fresh air and mental occupation. Massage is valuable as an anodyne for the relief of the lightning pains in the lower extremities and also the attacks of pain in the region of the spine. Centripetal effleurage of the lower extremities and deep petrissage over the spine are indicated.

To compensate for the impairments or loss of muscular co-ordination the patient should be taught to learn certain movements mechanically and by constant repetition educate his muscles to execute these movements in obedience to his will. Many methods and systems have been proposed for this purpose. They are all modifications of Fränkel's movement-cure for tabetics. The patient whose co-ordination is deficient, must be shown what movements he is supposed to execute. With the co-operation of his eyes to guide him, he will make a faint attempt. The attempt must be repeated over and over again until the muscles which are concerned in the movements have been mechanically educated to go through the motions easily and safely, even without the guidance of the eyes. With infinite patience and tactful consideration on the part of the physician and an equal amount of cheerful co-operation and willingness on the part of the patient much good can be accomplished. To keep the patient in a cheerful and tractable mood, the exercises or movements must not be carried to the point of exhaustion or even fatigue.

The easiest and least fatiguing movements must be tried first. To relieve the patient of carrying his weight, he should take his first exercises in the dorsal decubitus, afterwards in the sitting posture, and finally standing and even walking. The first exercises must be simple, *e. g.* extend-

ing or raising a foot or flexing the toes. Afterward the exercises can be more complex, *e. g.* combining the two movements named. In very weak cases it might be necessary to begin with passive movements or to combine active and passive movements. The patient must be taught to go through the motions accurately, not merely to move the limbs, but to move them in keeping with well-defined and well-understood directions. After a certain movement has been learned and can be performed without the assistance of the sense of sight, the physician can institute concentric or excentric resistance-movements of the muscles and parts that have been trained. (See chapter on MECHANOTHERAPY.) The movements themselves can be varied in an infinite variety of ways, *e. g.* by bending, straightening, abducting, adducting, raising, inverting, everting, rotating a toe, several toes, one foot, both feet, one leg, both legs in the lying-down, sitting or standing position. The patient may be taught to stand, to balance himself on one foot, to elevate his foot, his leg, his thigh, to place his foot forward, backward or in any other position, to walk a chalk-line or to step from one given point to another, to turn around, to step over obstacles, to sit down and rise, to ascend and descend stairs, etc., etc. Little by little the patient must be trained while his mind is kept in a cheerful frame. It is by no means easy to superintend a course of mechanical education as outlined above. Much judgment is necessary lest the patient be injured by too much exercise. He usually remains unconscious of fatigue and is liable to suffer irreparable damage. The best results are achieved in institutions where tabetics are taught in classes under the direction of a competent instructor. The treatment does not aim at a cure, but at removal of the most distressing symptom of the disease, *i. e.* loss of co-ordination. This form of kinesi-therapy is applicable in many allied disorders, principally in the treatment of paralytic conditions.

The suspension method, which has been championed by Charcot and Weir Mitchell, is a form of local mechano-

therapy that deserves to be better known and more extensively employed than it is. The seances should be short and be carefully watched. The method can be combined with the movement-cure or be independently used for the relief of pain along the spine. A special apparatus should be used. It resembles the Sayre-device for applying the plaster-jacket.

HYDRO- AND THERMO-THERAPY.—Kneipp's heroic hydro-therapeutic methods in the treatment of tabes, which have many advocates among physio-theraputists, consist principally in the employment of cold moist packs to the extremities and cold douches to the back, thighs and knees. In patients who are in fair general condition this method can be used with much benefit. After loss of co-ordination, vaso-motor disturbances usually supervene, which are a contra-indication to these severe applications. In their place hot applications might prove to be of value (small thermic cylinder to the back). Alternate douches of hot and cold water are productive of much good, especially in cases that suffer from pain in the spinal region. The general thermic eliminative treatment previously alluded to is of importance in view of the syphilitic character of practically all cases of tabes.

PHOTO-THERAPY.—The sun-bath in the treatment of tabes is a therapeutic agent of cardinal virtue. The effects of sunlight in the management of chronic diseases have been suggested in the chapter on PHOTO-THERAPY. The local use of ultra-violet rays in cases of tabes offers an interesting clinical problem, although the published reports of cases in which this form of photo-therapy was used suggest the optimism of the reporters rather than any well-established efficacy of the actinic rays under the conditions referred to. To render the parts bloodless and thus enable the rays to penetrate down to the degenerating nerve-tissue, cataphoresis of adrenalin is resorted to, as suggested by H. G. Piffard. The subject is interesting enough to justify further study. The Minin apparatus is useful as an ano-

dyne and also as a counter-irritant, taking the place of the more severe application of the actual cautery. Its use is painless and can be continued for hours.

ELECTRO-THERAPY.—In the first stages of the disease (negative to back, positive to feet, ten to fifteen milliamperes for ten to twenty minutes every day or two). During the second stage, opposite polarity should be used. Faradization helps to tone up the muscles. It can be applied in a warm-water bath. Static sprays or sparks to the spine are serviceable (negative during first stage of the disease, positive in the second stage and for the relief of pain). The high-frequency current applied by means of a vacuum-electrode is excellent and is only surpassed in therapeutic efficacy by a general application of high-frequency energy (D'Arsonval's cage or diasolenic cylinder). The general application is probably the best electro-therapeutic procedure in the treatment of locomotor ataxia.

VIBRATION.—Central vibration in the treatment of tabes is synonymous with peripheral vibration. The "center" happens to be the *locus morbi*. Pain and disorders of sensation frequently yield to rapid, gentle vibration, especially if vibration is preceded by massage of the afflicted portion. That vibration can influence the retrograde metamorphosis in the nerve-structure, is hardly likely. For the relief of many concomitant symptoms vibration is useful. Dyspepsia often adds an element of additional discomfort and may require deep vibration to stir up the solar plexus. Constipation is a common condition in tabetic subjects and may have to receive special treatment. (See CONSTIPATION.) I once had an opportunity of seeing Arnold Snow administer rectal vibration to an ataxic patient in the second stage of the disease. The patient suffered from spasmodic attacks of rectal tenesmus. The vibration gave the patient much relief.

The treatment of tabes dorsalis offers a vast field for therapeutic research and reasoning. It is essentially a chronic disease with a kaleidoscopic variety of symptoms.

While it is unfortunately a fact that the disease is practically incurable, there can be no doubt that a world of good can be done by physio-therapeutic means, not only in the relief of symptoms, but also in retarding the degenerative process which marks the pathology of the disease.

Lupus Erythematosus.—The treatment of this stubborn affliction by X-rays has not been uniformly successful, although some observers speak well of it. The Finsen-method is not effective unless arc-lights of immense amperage are used on comparatively small patches. The portable Finsen-lamps (five to ten amperes) are of no avail. Metallic electrolysis, as described under the head of **LUPUS VULGARIS**, is sometimes effective. Heat-rays (Minin-light, or sunlight concentrated by means of a sun-glass) have been known to cure superficial cases. The high-frequency current applied by means of a suitable vacuum-electrode is productive of good results in many instances. Even in cases of long standing the high-frequency current has been used successfully. Applications should be made every two or three days for five to ten minutes. A vapor or dry-heat bath once or twice a week is indicated in these cases.

Lupus Vulgaris.—The treatment of common lupus by concentrated chemical solar or electric arc light rays (Finsen-method) is referred to in the chapter on **PHOTOTHERAPY** (Part I of the book). The X-ray treatment is discussed in the chapter on **X-RAY-THERAPY**. Good results frequently follow well-applied metallic electrolysis by means of a positively charged copper-tip electrode which has been moistened with salt water and is slowly moved about. Negative (sponge) electrode is placed near by. Green discoloration indicates formation of copper oxy-chloride. Applications of high-frequency currents by means of a vacuum-electrode are often beneficial in the non-ulcerative variety of lupus vulgaris. The thermic solar rays concentrated by means of a sun-glass have been successfully used in the destruction and cure of lupus. The method is somewhat objectionable on account of the pain involved.

Malaria.—The different types of the plasmodium of Laveran thrive best where the conditions are favorable for fermentation and decomposition, *e. g.* in swampy, marshy, humid places, where the temperature is high and the air stale or even foul. This description—*mutatis mutandis*—applies to the conditions prevailing in the system of a patient suffering from the malarial poison: sluggish circulation, sub-oxidation, deficient elimination. Whether we believe that the anopheles is the carrier of the plasmodium, makes little difference. Swampy, marshy places can be made healthful by ventilation, air and sunlight. A malarial system can be restored by stimulating the circulation, promoting metabolism and increasing elimination. In either case the plasmodium can not thrive. Active regeneration of stagnant places makes it impossible for the plasmodium to become a pathogenic factor. Therein lies at once the principle of prophylaxis and treatment of the malarial state in and out of the human body. The details of treatment in all cases of malaria are: a carbo-hydrate (vegetarian) diet, irrigation of the colon, a sweat-bath every two or three days, as much sunlight and fresh air as possible. The liver must be kept active. Sluggishness of the whole system is usually coincident with and produced by sluggishness in the portal circulation. To counteract stagnation of this kind give abdominal massage, vibration over the stomach and liver and advise horseback exercise. Keep the blood fresh, metabolism active, elimination perfect, and the malarial state in its many forms will cease to exist (malaria, remittent fever, intermittent fever, biliousness, malarial cachexia, typho-malarial fever, etc.). For additional clinical information see FUNCTIONAL DISORDERS, DYSPEPSIA, MIGRAINE. Immunity against malaria consists in a perfect physiological equilibrium of metabolism. If the latter can not be established owing to a wretched condition of the system characterized by but little regenerating power, the only advice to give such a patient is to look elsewhere for more healthful surroundings.

An acute attack can undoubtedly be broken up temporarily by complete cinchonization of the system. In many cases the cure seems to be as bad as the disease. The stomach and liver are completely enervated and often remain so, even after a change of climate. Thus the momentary action of quinine which is gratefully acknowledged as a necessary evil, is not an unalloyed boon. Quinine does not remove the malarial *state*. To do this, the physio-therapeutic measures mentioned must be resorted to.

In the chapter on the THERAPY OF LIGHT, reference is made to the darkness-treatment of malaria. Patients were confined for days in dark rooms. The conclusion to be drawn from the apparently good results is not that the absence of light killed the plasmodium, but probably that the anopheles had no access to the dark room. The apparent immunity of the negro is easily understood when we consider that negroes are accustomed to an outdoor life and are usually free from disorders of digestion, assimilation and metabolism.

The experience of physio-therapists living in malarial sections has shown that a treatment in the dry-heat cylinder will break up an acute attack two or three hours after. While I have had bountiful opportunities to verify the value of physio-therapeutic methods in chronic malaria, I have had no personal experience with the acute form of the disease.

Melancholia.—The management of a case of melancholia does not differ from the therapeutic regime outlined under the head of NEURASTHENIA. The essential part of the treatment is to occupy the patient's mind. Suggestion is a valuable therapeutic agent. Change of surroundings is necessary in all cases. The most distressing feature in most cases is insomnia. This should be combated by cold moist packs to deplete the brain, and general massage to keep metabolism active. Galvanism (positive to temples and forehead, negative to spine) is beneficial. If there is a special cause for melancholia, remove it.

Meningitis.—The therapeutic directions for the management of inflammatory conditions of the brain, the cord and the enveloping membranes are practically identical and therefore, refer to all forms and varieties of pachymeningitis, leptomeningitis, cerebral congestion, cerebro-spinal meningitis, myelitis, etc. Absolute rest in bed is essential. It is of advantage to change the position of the patient from time to time. The patient should not remain on his back constantly. The intestinal canal should be washed out. The bladder-function must be watched. "Derivation" to the lower extremities and subsequent depletion of the upper parts of the body must be accomplished by hot vapor-baths, cold moist packs, hot dry packs or baths, dry-heat baths in thermic cylinder, or electric-light baths. Any of these procedures are applicable. The most effective plan is to give a vapor-bath (from feet to epigastrium) and follow it with a hot moist pack. The technique of the application is indicated in the chapter on THE THERAPEUTIC USES OF HEAT AND COLD and under the head of FEVER, INFLAMMATION, PNEUMONIA and other special subjects. When the stage of exudation has begun, the depleting methods indicated above must be pushed to the point of tolerance in order to force absorption. This is a matter of the utmost importance. In syphilitic cases the prognosis depends on the firmness and consistency with which these directions are enforced. For dietetic directions see DIET IN ACUTE FEVERS.

Locally leeches, cupping, cold applications or alternate applications of heat and cold are of value, but only as adjuncts. The essential features of treatment are the details of general management indicated above. The ice-bag on the head should be supplanted by a head-coil. The galvanic current is serviceable in helping to deplete the area of inflammation. The positive pole should be applied to the spine. Later on, faradization of the muscles, especially of the extremities, may be resorted to. Statistical evidence goes to show that the therapeutic regime outlined above not only improves the prognostic features of inflammation of

the brain, cord and meninges, but ameliorates the severity of the symptoms, shortens the duration of the attack and counteracts the permanent damage which the nerve-structures frequently sustain as a result of severe inflammatory disturbance.

Menorrhagia.—Therapeutic directions analogous to those given under the head of METRORRHAGIA.

Metritis.—General regime and local treatment are identical with the therapeutic directions given under the head of ENDOMETRITIS, with which metritis is usually associated.

Metrorrhagia.—Treatment should be planned and administered with due regard to the cause. To control bleeding, cold applications should be made to the abdomen and to the sacral region. In the extreme cases very hot vaginal douches might be necessary. Forcible massage and compression of the uterus, both through the abdominal wall and through the vagina, are often effective. It can be combined with faradic electricity (one pole in the uterus, the other on the abdomen, or one pole in the operator's unengaged hand, the other in the patient's hand while massage is being applied). The use of a (positive) copper-electrode (galvanic current) in the uterus is useful in some cases. Packing with gauze-tampons during the interval between treatments is indicated. Hydro-therapeutic "derivating" applications are always proper.

Migraine.—"Bilious headache" is the classical type of an acute auto-intoxication. The object of treatment should be to eliminate the absorbed toxins and to prevent a re-accumulation of toxins.

TREATMENT OF AN ACUTE ATTACK.—To prevent or abort an acute attack of migraine, the patient should be given a thermic treatment in the dry-heat cylinder or electric-light cabinet. The colon should be thoroughly irrigated and food withheld for at least eight hours. Locally the static head-spray (positive if face is flushed, negative if patient feels faint) should be given for ten to fifteen minutes once or twice during the attack. Pressure over occiput

has a sedative effect. Galvanization (positive pole on painful place, negative between scapulæ) is useful. Massage over the forehead and temples is helpful. Vibration over lower cervical and upper dorsal vertebræ is serviceable. After the thermic treatment the patient should be placed in the high-frequency cylinder (cage or diasolenic) for fifteen minutes.

TREATMENT DURING THE INTERVAL.—Outdoor life, sunlight, a vegetable diet, exclusion of alcohol, tobacco, tea and coffee, avoidance of excesses and excitement, daily irrigation of the colon, a reasonable amount of exercise and a weekly sweat-bath are indicated. Static spray to the back is useful. Galvanization (one pole over epigastrium, the other pole to spine) is a valuable adjunct. If the patient is plethoric and suffers from congestions, place positive pole on back. If patient is anemic and sluggish, use negative pole on back. The dietetic peculiarities of the patient should be studied closely. Frequently one special kind of food precipitates an attack. If the patient has trouble with his eyes, an oculist should be consulted.

Milk-secretion.—To *increase* the functional activity of the female breast, place negative pad-electrode on the breasts, positive on the back and treat daily for fifteen minutes with mild galvanic current. Also use negative static spray locally. Hot applications and massage are useful. To *decrease* milk secretion use positive current on the breasts, negative on the back. Technique as before. Cold applications and compressions are useful. In threatening mastitis use Bier's stasis by means of a suction apparatus. Otherwise see INFLAMMATION (ACUTE) and SEPSIS.

Moles.—(See VASCULAR TUMORS.)

Nasal Catarrh.—*Acute* rhinitis (cold in the head) requires general treatment similar to that given under the head of TONSILLITIS. A good sweat in the thermic cylinder frequently aborts an attack. (See INFLAMMATION (ACUTE) and FEVER.)

The *chronic* variety of nasal catarrh is one of the most

common conditions encountered in practice. It is seldom cured because the atmospheric conditions are a constant source of irritation and because local treatment is inadequate. General hygienic regulations must be enforced. (See INFLAMMATION, CHRONIC.) Locally the high-frequency current (nasal electrode) or metallic electrolysis (positive copper- or zinc-electrode to the affected surface, negative back of neck) ten milliamperes for five minutes every day or two. Mild, rapid vibration over the cheeks near the nose is beneficial. Local treatment is useless unless systemic treatment is enforced. Underlying causes (syphilis, etc.) should receive attention.

Nervous Diseases.—The therapy of degenerative diseases of the cord is suggested under the head of LOCOMOTOR ATAXIA. For therapeutic information concerning other neuropathic subjects see INFLAMMATION (ACUTE), INFLAMMATION (CHRONIC), PARALYSIS, REFLEX DISORDERS, FUNCTIONAL DISORDERS, HYSTERIA, NEURASTHENIA, MELANCHOLIA, EPILEPSY, etc.

Neuralgia.—The treatment depends on the cause because neuralgia (nerve pain) is always a symptom, never a disease. Hilton's famous definition of pain ("cry of a nerve for healthy blood") is a complete and expressive exposition of the nature of neuralgia. The latter is a symptom rarely of neuritis, sometimes of pressure of a tumor, foreign body, etc., on a nerve, not infrequently of toxæmia (syphilis, malaria, rheumatism, metallic poisons, etc.), but most commonly of auto-intoxication (absorption of derivatives of normal excreta and secreta due to dyspepsia, constipation, anemia so-called and disorders of nutrition produced by grief, worry, mental strain and other psychic factors). In all cases of stubborn neuralgia look to the stomach and its function (see DYSPEPSIA).

GENERAL TREATMENT.—The importance of increased elimination can not be too often repeated nor too strongly emphasized. What has been stated in this regard under the head of RHEUMATISM holds good in connection with

neuralgia. Elimination is the alpha and omega of successful treatment. The dry-heat cylinder, the electric-light bath and the sun-bath have a deep therapeutic significance in all cases of neuralgia. If the patient is plethoric, full-blooded and of a nervous temperament, put him on a simple vegetable diet. Exclude alcohol, coffee, tea and tobacco. If the patient is weak and pale, let him live on copious nitrogenous food. Improve his surroundings, physically and psychically. Even in cases of special neuralgia the general application of general high-frequency currents (cage or diasolenic) should be included in the treatment.

LOCAL TREATMENT.—Heat and manipulation are the best and most effective local agents in the treatment of neuralgia. Heat can be applied by means of the Minin apparatus, a small dry-heat cylinder or the local electric-light bath. The skin becomes hyperemic, the venous supply of the part is regenerated and waste-products are absorbed or excreted. The cry for healthy blood is stilled. More intense effects on local metabolism can be produced by cold applications if they are properly administered so as not to fail in their invariable object to bring on a reaction. Cold douches, thrown against the part with considerable force, were used by Kneipp. Cold moist packs applied to a distant part ("DERIVATION") were employed by Priessnitz. Kneipp's famous depleting method (walking in the wet grass or fresh snow) has cured many a case of sciatica and other forms of neuralgia. All these methods and agents, however, are incomplete without direct manipulation of the affected area.

When the suffering nerve and the contiguous territory should be manipulated, is an open question. It seems, however, as if local thermic treatments (such as indicated above) should be followed by an hour of rest before manipulations are begun. They are given in the form of pressure, massage, Swedish movements, vibration or oscillation.

Simple pressure usually relieves neuralgic pains. When the part admits of the application of a firm compression-

bandage, the latter should be applied and worn as a palliative measure. Massage of the aching nerve is worse than useless if it causes discomfort or pain. Massage in its various forms should be applied to the surrounding parts, not to the nerve-trunk directly. After the circulation of the contiguous territory has been stimulated, passive movements or in suitable cases excentric movements can be employed to intensify the effect of massage. It goes without saying that all massage-movements should be centripetal.

Vibration is useful both centrally and peripherally. Vibration of the affected nerve or plexus should never cause discomfort or pain. The technique is correctly given by Arnold Snow, who advises interrupted vibration with a fairly slow rate of speed. "It should be applied lightly at first; but, with increasing tolerance, be intensified, the diminution of pain being a guide as to the increase of pressure. If after a reasonable effort the pain does not cease or markedly lessen, vibration should not be persisted in. Treatments should be given daily. In obstinate cases it may be best to treat twice daily." Powerful vibration of the surrounding parts is always proper and adds in no small measure to the sum-total of benefit which the patient derives from vibration. The effect of vibration is undoubtedly due to intensified molecular motion, followed by an increase in animal-heat, oxidation and accelerated metabolism. It stands to reason that the applicability of the directions given depends to a large degree on the anatomical location of the nerve treated. The same holds good in regard to oscillation.

Central vibration for the relief of neuralgia has frequently yielded very good results. The vibration-table given under the head of PARALYSIS will be found serviceable in locating the spinal segments corresponding to certain anatomical regions of the body. There is no doubt whatever that the effects of central vibration are primarily in the general improvement of the nutrition of a (peripheral) part and secondarily in the benefit which accrues to an in-

dividual structure through improved nutrition of the region of which it is a component part. Thus, for obvious reason, vibration over the lower dorsal and the upper lumbar vertebræ would be indicated in cases of sciatica. The idea expressed by M. T. Pilgrim that instrumental vibration increases the natural vibration in a nerve and in this way produces physiological effects, is hardly tenable. Natural vibration in a nerve is its medium of carrying and transmitting impulses. Pain, considered in connection with nerve-physiology, is composed of accentuated sensory impulses. To increase the natural vibration of a nerve means to magnify the sensory impulses which it carries. Beyond a certain point of accentuation of sensory impressions the subjective condition is called "pain." This is a pathologic state. If instrumental vibration relieves pain, it either does so by obtunding the natural nerve-vibration or by increasing the natural nutriment of a nerve, thus enabling the latter to carry intensified sensory impressions without subjectively perceiving them as "pain."

The therapeutic suggestions given apply in all cases of so-called neuralgia. The stomach and the skin must receive the lion's share of attention at the hands of the clinician. For the sake of completeness the more common forms of neuralgia are added with suitable suggestions:

TIC-DOULOUREUX (NEURALGIA OF THE FIFTH NERVE).— "Derivating" baths or packs. Cold douches to lower extremities. Walking in wet grass or fresh snow. Sun-bath locally. Galvanism (mild current, positive pole moved over forehead, negative to back of neck). Positive galvanic current to aching points directly, negative to back of neck. Static spray (large or small) positive to head, negative to platform. Gentle stroking to painful spots. Locally dry heat. Cataphoresis of cocaine, chloroform or aconite is bad practice.

ODONTALGIA.—Sometimes a problem for a dental surgeon. Otherwise treatment does not differ from that of tic-douloureux.

CEPHALALGIA.—Not a true neuralgia. Usually congestive headache or due to auto-intoxication from stomach and intestines. Derivation as in the treatment of tic-douloureux. Positive static spray. Pressure over occipital region. Massage of forehead and temples. Vibrate over cervical vertebræ. Sometimes an ophthalmologic problem.

INTERCOSTAL NEURALGIA.—Dry heat. Galvanism, positive pole over painful spots. Derivation as before. Strapping the affected side is useful.

GASTRALGIA.—Heat externally by hot applications, internally by hot drinks. Positive galvanic pole in epigastrium, negative on the back. Static spray (positive) or wave-current to epigastrium. Hot sitz-baths. Liquid food.

OVARIAN NEURALGIA.—Hot sitz-baths. Galvanism (positive pole directly over aching spot or in the vagina, negative in lumbar region). Static spray (positive) to abdomen. Priessnitz pack to abdomen. Hot vaginal injections. Pressure over ovarian region.

LUMBAR NEURALGIA.—Rheumatic in character. (See RHEUMATISM, MUSCULAR.)

SCIATICA.—Pressure, compression-bandage, massage and vibration. Dry heat. Rest limb in elevated position. Galvanism as before. Static spray (positive) locally. Local sun-baths.

The local treatment of any neuralgia must always be secondary to the general treatment of the system. Local treatment is desirable, general treatment is necessary. Even in old, obdurate cases good results can be achieved if the physician will persist in handling his patient generally and locally according to the directions and suggestions given above.

Neurasthenia.—Nervousness in the widest and, therefore, in a constantly varying sense of the word is supposed to be a functional disorder of the nervous system. It is always a symptom and may be due to any number of causes. Bartholow's definition is probably as good as any: "Morbid mental condition produced by exaggerated suscepti-

bility to physical impressions." In looking for the cause of the affliction, give the stomach a large share of your attention. The symptomatology of the affliction is infinite. Neurasthenia is found in conjunction with most chronic diseases.

In attempting to handle a case of neurasthenia the physician should provide for his patient the best of hygienic surroundings. The four emunctories should be kept active, especially the bowels and the skin. Sunlight is indispensable. Occupy the mind of your patient pleasantly. This might be accomplished by a change of surroundings, travel, relief from business and other obligations and by suitable companionship. General massage, followed by a lukewarm rub-down and an hour's rest, is very serviceable in the neurasthenia of women. Exercise in the open air proportionate to a patient's tolerance, swimming, horseback riding, outdoor sports, etc.

If the neurasthenic state is the result of, or is associated with, some chronic ailment, treatment should be directed to the cause. The patient's sexual life often furnishes the clew to the situation. The mental state of the patient is frequently a problem which can only be solved by one who is familiar with the patient's family history and with the details of the patient's private life. These should be taken into consideration and should be made the means of reaching the patient's mind and nervous system by suggestive influences. In a few instances the rest-cure as advocated by S. Weir Mitchell will be found serviceable. In many cases, however, absolute rest and isolation mean aggravation of the neurasthenic state.

The application of the high-frequency current to the spine by means of a vacuum-electrode or a general high-frequency treatment in the diasolenic cylinder or D'Arsonval's cage is a powerful therapeutic agent in cases of neurasthenia, especially if the patient is an ill-nourished, anemic subject. Galvanization or faradization of the spine is useful in many instances. Vibration in carefully selected

cases is very beneficial. In the form of neurasthenia which is associated with nervous dyspepsia, vibration over the dorsal, epigastric and both hypogastric regions is very effective. If the patient is a malarial, rheumatic or syphilitic subject, general eliminative treatment is necessary. The diet of a patient should be adapted to his general condition and to the tolerance of the stomach. Usually a moderate nitrogenous diet, excluding fats, pastry, spices, coffee, tea and alcohol, is adapted to these cases. Tobacco should not be allowed. Most cases do better if they are treated away from home. Many times it is possible to act upon the patient's nervous system and mind through the special senses. (See chapter on PERSONAL HYGIENE.)

Night-sweats are produced by auto-intoxication and resulting vaso-motor disturbances in the skin. Patients who are handled according to the regime outlined under the head of TUBERCULOSIS PULMONUM do not usually suffer from night-sweats. It is only patients who are housed up, improperly fed and treated without regard to the more or less hygienic character of the surroundings, that sweat at night (Brehmer). A positive static insulation toward evening followed by a lukewarm sponge-bath usually breaks up night-sweats. Treatment should be given every evening.

Obesity.—Oertel's treatment of obesity consists in systematic dehydration of the system (see VALVULAR DISEASES OF THE HEART) and augmented oxidation (mountain-climbing to expand the thorax and augment the amount of oxygen). He emphasizes the necessity of counterbalancing the physiological effects of these methods by a suitable diet (albumen in excess, carbo-hydrates in moderate quantity, fats and starches excluded).

If the reduction of fat is done at the expense of the digestive function, it is harmful. The drinking of vinegar, the eating of soap, the use of cathartics are objectionable for the reason indicated. The treatment of obesity is difficult because cases must be properly individualized and on account of the co-existence of other diseased conditions. In

rheumatic and gouty cases of obesity the diet should consist of garden vegetables well cooked and cut crosswise to the fiber (carrots, parsnips, turnips, spinach, lettuce, onions, celery, cauliflower, cabbage, beets, string beans). In addition to these, fresh-water fish, wheat gluten, white of egg and skimmed milk. Keep bowels open. If there is no rheumatism or gout, lean beef, mutton or chicken might be allowed and milk excluded. Starches and fats (all fried foods) should be forbidden. Coffee, tea or alcohol can be allowed in very small quantities, water as little as possible. If the heart is good, the dry-heat cylinder or general electric-light bath can be employed every three or four days. Chest-exercise, mountain-climbing, general massage and Swedish movements, fresh air and sunlight should be added to the dietetic regime. (See chapter on DIETETICS. See RHEUMATISM.)

Occupation-neuroses.—This term refers to a number of conditions characterized by painful cramping, weakness or extreme sensitiveness and irritability of certain muscles as the result of overexertion of these muscles. The most familiar form of an occupation-neurosis is writer's cramp. Other types are observed in the hands and wrists of piano-players and violinists, in the calves of dancers, in the lips of cornetists, all of whom constantly use certain muscles until muscular tone is exhausted. The therapy consists in rest, massage, mild faradization or galvanism of the afflicted muscles. Vibration along the course of the principal nerve-trunks of the part, also central vibration as indicated in the vibration-table under the head of PARALYSIS. In treating the wrist, a dry-heat treatment in a small thermic cylinder or local electric-light bath, followed by a high-frequency treatment of the whole arm, is useful. Massage of the muscles near the afflicted part helps to tone up the muscular structure of the whole member and incidentally strengthens the afflicted arm. Treatment should be given every day or two. Later on, Swedish movements of the affected region can be added.

Orchitis.—General therapeutic principles under INFLAMMATION (ACUTE). Ice-applications are of doubtful propriety. In the chronic forms of the disease the Minin light is of value. Galvanism (testicle between the two sponge-electrodes) is useful. Bennett recommends immersing scrotum in a cup of water, using the water as one of the conductors. In acute orchitis put positive wire into the water, negative to feet. Galvanism, ten milliamperes, ten to fifteen minutes. In the chronic form reverse polarity and use for five or ten minutes. Massage of the enlarged testicle is beneficial.

Pain.—Find the cause. Symptomatic relief may be had from the judicious employment of pressure (in accessible passive congestions, some forms of neuralgia), massage (muscular rheumatism, passive congestions), heat (in most inflammatory conditions), cold (in some inflammatory states, suppuration), Minin light, X-rays, high-frequency currents, positive pole of galvanic and static currents, vibration, sun-bath, various kinds of hydro-therapeutic applications and—last but not least—suggestion. (See FUNCTIONAL DISORDERS, REFLEX DISORDERS, RHEUMATISM, etc.)

Pain is never a pathological condition, but always a guide-post to some seat of disturbance. The proper treatment always depends on the cause.

Palpitation of the Heart.—A cold application to the precordium usually has a sedative effect. Other means of relieving an acute attack are: positive static insulation, deep vibration over upper dorsal vertebræ, galvanization (negative side of neck, positive precordium), lukewarm bath, hot pack to lower extremities. Try to find the cause and remove it. (See DYSPEPSIA, FUNCTIONAL DISORDERS, REFLEX DISORDERS.)

Paralysis.—Impairment, perversion or loss of motion, inasmuch as it is a peripheral effect, is only a symptom and must be dealt with, with due regard to the cause primarily concerned in the production of the paralytic state. The cause may be disease of nerve-tissue, inflammation of

nerve-sheaths, hemorrhage and subsequent pressure of a blood-clot, tumors, etc., etc. It may be a hemiplegia, if it involves a lateral half of the body; a paraplegia, if it involves the body from the waist down; a monoplegia, if it involves a single member. Not all paralyses are effects of structural lesions. Hysterical paralyses are not infrequent. Sometimes paralyses are evidences of auto-intoxication and disappear when the cause ceases to act. Some forms of paralysis are toxic in character (*e. g.* the post-diphtheritic variety). At times paralysis appears as the symptom of a gradually supervening or progressive deterioration of the nervous system. On general principles we may consider the curability of the paralytic state in direct proportion to the tractability of the underlying condition. In keeping with the anatomical site of the lesion paralyses are said to be of encephalic, spinal or peripheral origin.

GENERAL TREATMENT.—If a paralytic condition is due to auto-intoxication, toxemia, or some systemic (blood) disease, it is of vital importance to correct the hygienic surroundings, to adapt the dietetic habits to existing conditions and to regenerate the nutritional state by promoting and correcting metabolism. Stimulate oxidation by fresh air and sunlight. Feed the patient on an excess of tissue-consumers (vegetable diet), unless there is a slow and gradual loss of weight which would have to be met by a supporting nitrogenous diet. Keep the kidneys active by liberal potions of fresh water. Irrigate the colon every day or two. The general electric-light bath or the dry-heat body-cylinder should be used every three or four days. General massage, static insulation, the galvanic or faradic water-bath, the wave-current to the spine, the body-diasolenic or auto-condensation couch may be added for their powerful tonic effects.

LOCAL TREATMENT.—Among the various therapeutic agents that are used to restore the functional power of muscles, the most available one is undoubtedly massage. The afflicted parts should be manipulated by effleurage, petris-

sage, friction, tapotement, successively and conjointly. Thermic stimuli (local electric-light bath, Minin light, hot applications, alternate hot and cold douches) are useful to improve local nutrition. The electric (faradic or galvanic) water-bath can be employed if an arm or a leg is to be treated. Vibration over the affected region is a valuable adjunct. Static sprays and in suitable cases sparks may be given locally. The electric massage-roller answers nicely in some cases.

Central stimulation by manipulation and vibration of the spine is of importance in the treatment of paralytic cases. The following list of control-stations may serve as a guide in the manipulation and vibration of the different portions of the spine:

Segment of the cord corresponding to the location of the first cervical vertebra controls motion of the following muscles: recti laterales, rectus capitis, anticus, posticus, sterno-hyoid, sterno-thyroid.

Second and third cervical: sterno-mastoid, trapezius, scaleni, omohyoid, diaphragm.

Fourth cervical: diaphragm, deltoid, biceps, coracobrachialis, supinator longus, rhomboid, supra-spinatus, infra-spinatus.

Fifth cervical: deltoid, biceps, brachialis anticus, long and short supinator, deep scapular muscles, rhomboid, clavicular portion of pectoral muscles.

Sixth cervical: deltoid, biceps, brachialis anticus, subscapular, pectoralis, serratus magnus, triceps, pronatores, latissimus dorsi.

Seventh cervical: triceps, extensores, pronatores, flexores, subscapular pectoralis, latissimus dorsi.

Eighth cervical: triceps, flexores digitorum.

First dorsal: extensores pollicis, musculi manuum interni, musculi thenares et hypothenares.

Second to twelfth dorsal: muscles of back, abdominal muscles, and spinal erectors.

First lumbar: none.

Second lumbar: vastus internus.

Third and fourth lumbar: sartorius, adductors, abductors, flexores and extensors of thigh.

Fifth lumbar: flexors of knee, flexors of ankle, peronei, extensors of toes.

First and second sacral: muscles of calf, glutæal muscles, peronei, extensors of ankle, small muscles of the foot.

Third, fourth and fifth sacral: muscles of the rectum, bladder and genital organs.

Paralysis may be associated with loss, perversion or impairment of sensation (anesthesia, loss of sensation; paresthesia, perverted sensation; hyperesthesia, increased sensibility). Manipulation and vibration of the spine is capable of influencing these conditions. The following list may serve as a guide:

Second and third cervical: occipital region and back of neck.

Fourth cervical: neck, front of shoulder and outer portions of arm.

Fifth cervical: back of shoulder, outer portion of arm to the wrist.

Sixth cervical: outer portion, front of forearm and back of hand.

Seventh cervical: radial side of hand, palm, index and one-half of middle finger.

Eighth cervical: ulnar portion of hand, dorsum of hand and inner portion of forearm.

First dorsal: inner side of forearm and arm.

Second dorsal: inner side of arm near and in axilla.

Second to twelfth dorsal: chest, abdomen, upper glutæal region.

First lumbar: groin and front of scrotum.

Second lumbar: lumbar region, outer and upper portion of thigh.

Third lumbar: front and outer side of thigh.

Fourth lumbar: inner side of thigh, leg and foot.

Fifth lumbar: back of thigh, outer portion of leg and ankle, sole and dorsum of foot.

First and second sacral: back of buttock and thigh, side of leg and ankle, sole and dorsum of foot.

Third, fourth and fifth sacral: anus, rectum, penis, urethra, vagina and perineum.

Knowledge of these anatomical points enables the physician to make direct application of any suitable therapeutic agent to the spinal centers for the purpose of influencing peripheral manifestations. The osteopaths aim to loosen the muscular structure of special parts of the back and correct the relative position of the vertebræ by manipulation and by Swedish movements. The application of vibration is based on the same principle, although, as far as therapeutic efficacy is concerned, it is not equal to the osteopathic method of manipulation, the claim of some anxious vibrator-makers notwithstanding. It is always wise to combine vibration of the spine with vigorous massage of the muscles of the back and with Swedish movements to engage certain muscles and in this way force motion of the individual vertebræ in relation to the contiguous vertebræ. The same principles, in a somewhat varied sense, apply to hydrotherapeutic procedures (douches and packs of the back). The direction in which electrical force travels can not be perfectly controlled when applications of a galvanic, faradic, static or high-frequency current to the spine are made. In cases of paralysis and loss of sensation the static spark applied directly to the spinal region is probably the most direct and most effective mode of application. Its action may be peripherally supplemented by sparks or faradic shocks applied to the affected muscle or muscles. For this purpose the rheotome in connection with a faradic current is very serviceable. The wave-current applied to a paralyzed muscle by means of one or more pieces of block-tin is very useful. The region treated will, by its anatomical location and peculiarities, to some extent determine the exact manner of electro-therapeutic application and technique. To increase the nutrition and metabolism in any affected region local applications of a mild galvanic current or a static spray

or a high-frequency current may be added. For faradic and galvanic applications one pole should be placed over the point of insertion (or origin) and the other over the belly of the muscle. Electrodes carrying galvanic currents should be shifted about. The average duration of an electrical treatment in these cases is fifteen minutes, to be repeated every day. Sparking should not be done for more than five or ten minutes. Unnecessary irritation of the skin must be avoided.

CLINICAL SUGGESTIONS.—In treating a case of paralysis the physician should never forget that he is dealing with a symptom and not with a disease *per se*. He should never lag in his efforts to find the cause. This, of course, is not always possible. General eliminative treatment by means of the dry-heat cylinder, the general cold moist pack, the electric-light bath, will benefit the majority of these cases, especially those that suffer from some form of intoxication. The stomach of the patient should receive painstaking attention. (See DYSPEPSIA.) The patient should not be allowed to suffer from constipation. The skin must be kept active. In this way the absorption of a clot is promoted, ill-nourished nerves and nerve-centers are stimulated structurally and functionally and toxins of all kinds (disintegration-products of normal secreta and excreta, ptomaines, derivatives of germ-cultures as in post-diphtheritic paralysis, lead in plumbism) are eliminated. There is no doubt that even in cases of paralysis produced by psychic causes the actual etiology of the paralytic state is an auto-intoxication due to disturbed nerve-function and a retention of derivatives of normal secretions and excretions. The physiological equilibrium of metabolism is disturbed, auto-intoxication is the result, with neuroses of divers kinds as the external evidences of poisoned nerves and nerve-centers. If our neurologists, most of whom are satisfied to treat their patients symptomatically and cover up a dearth of diagnostic exactness with a formidable mass of neurological and neuropathic *termini technici*, would only learn to return to

the simplicity of physiological facts and name causes and not concomitant or consequential phenomena! There was once an old maid in Cincinnati who developed paralysis and was pronounced hopelessly afflicted by a number of prominent physicians, among them three nerve-specialists. She went from bad to worse until an empiric outside of the profession took hold of her case, treated her with massage, a vapor-bath cabinet and a rectal syringe and cured her in less than three months. The therapeutic suggestions given hold good in all cases of paralysis, especially those that are of recent origin and are not produced by a trauma. In cases of long standing structural changes, especially the proliferation of connective tissue and the consequent atrophy or degeneration of the neurons, have taken place, the prognosis is accordingly unfavorable (*e. g.* in advanced cases of locomotor ataxia). Hysterical paralyses are accessible to suggestive influences in not a few instances. If the paralysis is due to a trauma or pressure of a tumor, foreign body, abscess, etc., the case offers a distinctly surgical problem with a prognosis proportionate to the tractability of the cause and the extent of the structural damage already done. In making a diagnosis the actual existence of paralysis must be determined. Incomplete paralysis (or paresis, to use a term frequently employed) may be in reality a weakness of muscular tissue and may be due to some local trouble, *e. g.* disease of a neighboring joint.

The adaptation of the therapeutic suggestions for the general and local treatment of paralysis will necessarily depend upon the etiology of the affliction, the seat of the lesion and the varying features of the clinical picture which the individual case presents. By way of recapitulation and specialization the following therapeutic summary is offered for practical guidance:

HYSTERICAL PARALYSIS.—Hygienic measures. Suggestion. Regulation of sex-function. General massage. Faradization of spine. Faradic bath. Faradization of affected part. Isolation of patient and forced feeding are recommended by S. Weir Mitchell. Every form of static elec-

tricity can be employed. In many cases the stomach is at fault. (See *DYSPEPSIA*.) Frequently it is possible to affect hysterical subjects favorably through the special senses. (See chapter on *PERSONAL HYGIENE*.) The influence of music on patients of this class has often been demonstrated.

INFANTILE PARALYSIS.—Hygienic measures. General depletent baths or packs. "Derivating" hydro-therapeutic applications. Local massage and faradism are very useful. General high-frequency applications.

DIPHTHERITIC PARALYSIS.—Elimination through the skin. Diasolenic cylinder. Faradic or galvanic bath. Locally faradism and massage.

BULBAR PARALYSIS.—Liberal diet, food being introduced per rectum or by means of a stomach-tube. Massage, especially to affected parts. Galvanism to muscles of neck and floor of mouth. Cold douches and static sparks to back and affected portion. In some cases of hyperesthesia the hot douches and a mild galvanic current to the spine are better borne. Static spray to neck and lower portion of face. Mild vibration to back of neck.

ATROPHIC PARALYSIS (PROGRESSIVE MUSCULAR ATROPHY).—General high-frequency treatments, faradic and galvanic baths alternately given. General massage. Locally rest, galvanism or faradism, massage and hot applications. Dry heat cylinder in syphilis and other underlying systemic conditions. Sun-baths.

FACIAL PARALYSIS (BELL'S PALSY).—Open bowels. Dry heat or electric-light bath. Fresh air. Sun-baths. "Derivating" hydro-therapeutic applications. Locally massage, galvanism and faradism. Cupping in front of ear. Static spray. High-frequency current to affected region.

PARALYSIS AGITANS.—Hygienic measures. Eliminative measures. Nourishing diet. Static insulation. High-frequency currents. Locally faradic or galvanic applications (bath or otherwise), high-frequency currents, massage, vapor-baths to affected parts. Vibration, alternate hot and cold douches to spine.

GENERAL PARALYSIS OF THE INSANE.—The general directions given above apply with supreme emphasis in this most peculiar and most unfortunate condition. The treatment should aim to promote the constructive metamorphosis of the organism. (Hughes.)

The proper therapeutic indications for all other forms of paralysis and pseudo-paralysis (paresis) can without much difficulty be deduced from the previous considerations and suggestions. In some cases of paralysis the movement cure of Fränkel can be employed with success. (See **LOCOMOTOR ATAXIA.**)

Papilloma.—(See **VASCULAR TUMORS.**)

Pelvic Adhesions and Exudates.—Many chronic diseases of women consist of, are associated with and are aggravated by the presence of adhesions and inflammatory exudates. The latter are the etiological factors in not a few cases of versions and flexions of the uterus.

Adhesions should be broken up by intra-pelvic massage as suggested by Thure Brandt. Reference to this subject has been made in the chapter on **MECHANO-THERAPY**. Faradization (one pole in the cul-de-sac, the other on the abdomen) frequently enhances the effect, especially in old cases. If pain and a subacute catarrhal condition supervene, massage is usually contra-indicated. In these cases hydro-therapeutic applications should be made to force depletion and absorption. A suitable electrode (positive) in the cul-de-sac (negative pad on abdomen) should be used every other day, galvanism twenty milliamperes for five minutes. The seat of the trouble should, if possible, be brought between the two poles. The application can often be made on the abdomen (positive) and on the back (negative). The older the case, the safer and less discomforting it is to use the negative pole in the vagina as close to the affected region as possible. If the symptoms are acute, the positive pole should be used in the vagina, or, better still, the electro-therapeutic treatment should be desisted from. Cases of old pelvic adhesions have been cured by means of

mercuric cataphoresis. (For additional information concerning the latter see **INOPERABLE MALIGNANT DISEASE.**) The applications in these cases are made by means of mercury-covered electrodes placed in firm contact with a surface close to the adhesion to be broken up. Faradization and massage are valuable adjuncts. The same holds good in regard to exudates. If they are old and can be handled without giving rise to pain, intra-pelvic massage should be given to start a reaction. Electro-therapeutic indications as before. In many cases the intra-vaginal use of the high-frequency current is of advantage in helping to regulate the circulation and promote absorption. Massage is practiced by one or two fingers in the cul-de-sac as close to the seat of trouble as possible, the other hand of the operator being used on the abdomen to steady and immobilize the affected region. If the exudate can be plainly felt through the abdominal wall, massage and galvanization are easily administered. Vibration locally is of advantage if the exudate is accessible through the abdominal wall or the vagina. Additional therapeutic directions are given under the head of **INFLAMMATION (CHRONIC).**

Pericarditis.—The regime in all inflammatory affections of the heart (pericarditis, myocarditis, endocarditis, pericardial effusions) is practically the same. Mental and physical rest are of the utmost importance. Leeches or cupping are of advantage in the early stages of the disease. Locally cold applications by means of a water-coil are serviceable. They should not be ice-cold. Heat is usually not well borne. Cold moist packs to the lower extremities and other hydro-therapeutic measures to stimulate skin-function and elimination are to be depended upon to sustain the heart and to absorb effusions. The general principles are discussed under the head of **PNEUMONIA.** The bowels should be kept open and the patient fed on milk and other concentrated food-drinks as suggested in the treatment of acute gastritis. Other therapeutic suggestions are given under the head of **INFLAMMATION (ACUTE)** and **FEVER.**

Peritonitis.—The *acute* form is usually secondary to some other condition (trauma, sepsis, perforation of intestines, inflammation in contiguous territory, etc.) and depends, therefore, for its treatment on the management and removal of the cause. Considered independently of any causative or associated condition, its treatment, as far as the general features are concerned, is conducted according to the principles which should prevail in all inflammatory and febrile conditions. (See INFLAMMATION and FEVER.) Rest is imperative. If the bowels are intact, they should be freely and frequently evacuated by enemata. An abdominal compress (Priessnitz pack, local vapor-bath) has a depletent effect and is a very useful local anodyne. In many instances the question of treatment may be altogether a surgical problem from the beginning.

The *chronic* form of peritonitis requires rest, depletion by hydro-therapeutic derivation and many other therapeutic measures indicated under the head of INFLAMMATION (CHRONIC). In the tubercular variety X-ray treatment (moderately hard tube, fifteen to twenty inches above abdominal wall, five to ten minutes every two or three days) has been recommended by some. High-frequency applications over the abdominal wall are sometimes beneficial, likewise local galvanization (two flat electrodes, positive on abdomen, negative on the back, weak current for five minutes every day). The value of fresh air and the actinic rays is shown by the wonderful improvement which at times follows mere opening of the abdomen, enabling air and light to enter. Vibration, massage, and all other violent forms of manipulation are contra-indicated locally, but might be advantageously employed in contiguous territory (legs, back) to stimulate absorption.

Pharyngitis.—(See TONSILLITIS.)

Piffard Rays are produced by a spark-gap lamp devised by Henry G. Piffard, of New York. They are different from the ultra-violet rays, do not affect the silver in photographic plates, but cause a quick and decided reaction on exposed skin. Little is known about these rays. They have

been used with apparent benefit in cases of lupus erythematosus.

Pleurisy.—The regime is similar to that outlined under the head of PNEUMONIA. Cupping or venesection are of benefit. Strapping the affected side by means of adhesive plaster is indicated as an anodyne. Absorption of effusions is best accomplished by powerful stimulation of the skin-function (general cold moist pack, thermic cylinder, general vapor-bath, as described under the head of FEVER, electric-light bath, Minin apparatus). For general therapeutic directions see INFLAMMATION (ACUTE) and FEVER.

Pneumonia (Lobar).—Acute inflammation of the lungs is classified among the infectious diseases produced by a bacterial cause. The specific micro-organism which is supposed to be the etiological factor in the disease is the diplococcus of Fränkel, although the pneumococcus of Friedländer, the typhoid bacillus, the various pus-germs and a number of other micro-organisms are credited with being capable of producing the disease. The vast difference of opinion makes the specific etiology of pneumonia very doubtful. There are not a few clinicians who look upon the bacterial element as being purely incidental to the inflammatory process. It is thought that the germs are present everywhere and at all times, but that they never develop and multiply until inflamed lung-tissue furnishes a favorable culture soil. Inoculation-experiments make the bacterial cause of pneumonia appear very doubtful. That atmospheric conditions, draughts, exposure to cold, sudden changes in the temperature are predisposing, if not productive causes, is admitted on all sides. That it may occur as a complication in the course of typhoid fever (typhopneumonia), rheumatism, gout, diabetes and chronic disease of the kidneys, there is no doubt. Pneumonia attacks by preference young, vigorous males. Alcoholism, tobacco-habit and addiction to an exclusive meat-diet make the prognosis very grave, because of the loss of resisting power on the part of the nervous system and the heart.

Croupous pneumonia (acute inflammation of the lungs) is the classical type of a self-limited disease. In an individual having ordinary good health, the disease, if left alone, and the ordinary hygienic regime being enforced, ought to run its course and terminate in recovery. There is no acute disease which is more interfered with by meddling drug-therapy to the detriment of the patient, than pneumonia. The drugging usually begins at the outstart when aconite and veratrum, strychnine and alcohol are called into requisition. In years gone by, venesection was practiced during the first stage of pneumonia. It has become obsolete, although its rationale as an antiphlogistic is unquestioned and a good deal more logical than the action of the various medicinal agents which have supplanted it. The loss of blood incidental to venesection has a tendency to lessen the patient's resisting power. Venesection without loss of blood would be the ideal antiphlogistic method. This is what hydro-therapy has given us in the various modes of water-application which are known as "derivating" methods. "Derivation" (depletion of the congested area) is the alpha and omega of treatment during the first stage of the disease in every case. It has a tendency to abort or jugulate the disease or, failing in this, to render the course of the disease comparatively mild.

The onset of pneumonia is usually announced by a tempestuous reaction on the part of the system (chill, convulsions, severe vomiting), followed by a rapid rise in the temperature. Embarrassment of the pulmonary circulation is marked by a rapid but full pulse, quick breathing, short inspiration and long expiration accompanied by a moan, anxious facial expression, pain near the nipple, intense prostration, etc. The picture is too characteristic to be mistaken. The treatment in this condition (I am almost tempted to call it specific treatment) hinges upon the application of the cold moist pack from the feet to the costal border. The technique of this most useful hydro-therapeutic application is clearly set forth in the first part of this

book under the head of HYDRO-THERAPY. The congested area must be depleted by drawing the bulk of the blood to the lower portions of the body. This is venesection without loss of blood. The pack should last an hour and be repeated two or three times daily. It should be applied without disturbing the patient. In some cases it is of advantage to make a cold application to the chest while the first pack is being applied. An ice-cap to the head is useful, especially where head- and brain-symptoms are present.

The air in the sick-room should be fresh and pure, not too cold and not too dry. The room should be well-ventilated, the patient being protected against draught. If the room is cold, a grate-fire can be kept up. The temperature should not exceed 70° F. If the air is too dry, a little water in a pan can be placed over a spirit-lamp and slowly evaporated. The inhalation of moisture-laden warm air is a splendid means of relieving cough. The room itself should by no means be allowed to become too moist; 80 to 90 per cent of moisture in the air, as shown by the hygrometer, is desirable in cases of pneumonia, especially if the cough is distressing.

After a pack has been removed, a gentle dry rub-down over the whole body should be administered. In this way the skin is kept active. A local hot application is made for the relief of pain in the chest. If after the first two or three packs the general condition of the patient is improved, the temperature reduced and the skin appears moist, the pack may be given from the feet to the neck. Physical and psychical rest is of the greatest importance in cases of this kind. The bowels should be opened by an enema. Gentle massage of the abdomen should be administered from the right iliac space upwards toward the liver, then horizontally across toward the left hypochondrium, then downward toward the left iliac space. In this way distention of the abdomen is prevented and regular evacuations are promoted. (See DIET IN ACUTE FEVERS.)

The regime indicated leaves the patient's heart in good

condition. The second stage of the disease (exudation, red hepatization) is mostly feared on account of the condition of the heart. The most common cause of a lethal result is cardiac failure. The arterial pressure is considerable, the strain on the right side of the heart taxes the organ to the utmost. The vaso-motor exhaustion is seen in the relaxed peripheral vessels. This grave condition of affairs is best marked in those cases that have been subjected to the action of heart-irritants (stimulants, depressants). For this reason the alcoholic subject is notoriously a ready victim of pneumonia. The best argument in favor of non-medicinal treatment during the first stage and the enforcement of a strictly hydro-therapeutic regime is the gradual change in the professional opinions concerning the propriety of any special form of medication. The best clinicians to-day recommend to open the bowels and to administer some therapeutic agent to keep the skin and the kidneys active. The most favorable statistics in pneumonia have been furnished by the hydro-therapeutic institutions in Europe. (Winternitz.)

During the second stage of the disease the object of treatment is to keep up the heart and to control hyperpyrexia. If the temperature exceeds 103° , cold sponge-baths should be administered followed by a dry rub. The temperature is not reduced by the cold water, but by the increased activity of the skin which radiates heat-units in response to stimulation. To keep up the heart, the patient should remain in the recumbent posture. Stimulating packs of the lower extremities should be given two or three times daily. A hot application to the feet should be kept up constantly. The skin of the lower extremities should be moist. Occasionally a lukewarm sponge-bath, followed by a dry rub, should be given to the lower limbs. During this stage of the disease, judicious use of coffee, tea or of alcoholic stimulants in any form is of advantage.

Locally the use of ice-bags has been recommended. (See reference to this subject under INFLAMMATION.) Recently

the employment of intense dry heat (thermic cylinder) has been championed. Neither the one nor the other should meet with unqualified endorsement, although the ice-bag seems to meet physiological indications in a certain sense. The objection to extreme heat and extreme cold is clear. Both have a tendency to suspend vital functions in the skin and the underlying tissues. They produce anesthesia by paralyzing the sensory nerves. The effects of either intense cold or intense heat on the seat of the disease are illusory. If the temperature in the inflamed lung-tissue can be so lowered or so elevated as to destroy the vitality of the pathogenic germs, the tissue itself would be impaired, because life is not possible beyond certain physiological extremes of temperature. Intense heat continuously applied to the inflamed lung (if such could be imagined) would disintegrate the aqueous elements of the blood by coagulating the albumen and by destroying the white corpuscles which are supposed to play the part of phagocytes. That the heart is bound to suffer by aggravation of the local reaction, is clear. The thermic cylinder, locally used in pneumonia, seems, therefore, to be of questionable utility. In inflammatory conditions of the pleura its use is productive of good results. The employment of the ice-bag in pneumonia is less objectionable. It frequently relieves the local symptoms, although its exact physiological *modus operandi* is not quite clear.

Both for the purpose of producing a local antiphlogistic effect and also to relieve pain, cupping by means of a vacuum apparatus is frequently useful.

A small portable faradic battery can frequently render good service in supporting a weakening heart. Mild faradization of the vagus is a splendid heart-tonic.

To relieve headache, gentle massage on both sides of the nape of the neck or pressure over the occiput may be resorted to. A moderately cold bath to the face, followed by stroking from the median line of the forehead towards and over the temples on both sides simultaneously is a use-

ful sedative. In case of threatening collapse the hypodermic injection of normal salt solution should be resorted to.

During the third stage of the disease (resolution, gray hepatization) the treatment does not differ from the regime during the second stage. Rest and perfect hygienic surroundings should be enforced throughout. Inhalation of oxygen or ozone is of value in many cases. A liberal constructive diet should be allowed when convalescence has begun.

The therapeutic suggestions pertaining to the treatment of acute pneumonia practically contain the therapy of many allied conditions such as congestion of the lungs, edema of the lungs, hypostatic pneumonia, catarrhal pneumonia, etc. In conditions in which, owing to weak heart-action, blood-stasis occurs in the most dependent portions of the lungs, an occasional change in the position of the patient is necessary.

Premature Labor.—Justifiable abortion can be induced by secondary faradic current (one pole in uterus, other pole on abdomen) for five minutes. Rapidly interrupted galvanic current does as well.

Prostate Gland (enlarged).—Newman advises negative electrolysis analogous to electrolysis of strictures. Cathaphoresis of K I is advised by some (positive on sacrum, negative on cotton saturated with K I solution to perineum). Positive static spray or wave-current to perineum and supra-pubic region is very soothing. Hot vapor sitz-baths and hot rectal injections are useful.

Pruritus Vulvæ.—After enforcing absolute cleanliness of the vagina, an application of positive galvanic electricity (five milliamperes for five to ten minutes every day) should be made. A local positive static spray is very useful. The high-frequency current applied by means of a flat vacuum-electrode is very serviceable. Cold douches to the vulva improve the local circulation and skin-function. The local electric-light bath is very valuable for the same reason.

Reflex Disorders.—Nerve-function may be disturbed by conditions of auto-intoxication. (See FUNCTIONAL DIS-

ORDERS.) In addition to this the influence of sense-impressions received by the organs of special sense (skin, eyes, ears, nose, tongue) is an element of importance in the causation of many so-called reflex disorders. Last but not least, the mind has a controlling interest in the economy. An impetus received by the mind (psychic impression) or by the organs of special sense is capable of increasing, decreasing and otherwise altering the nutrition and, therefore, the activity of the nerves. The sympathetic nervous system is the one incalculable factor in the functional potency of the whole organism. Its action is past human ken and speculation. It is the eternally personal and soul element in the individual body. It is the one factor which creates the ever-changing variability of subjective disease-symptoms. The sympathetic nervous system is in touch with every fiber and cell in the body. Thus it is that impulses reverberating through its exquisitely fine network may cause sympathetic vibration anywhere and everywhere in the organism. The path along which the impulses travel have as yet not been explored by either chemist or physiologist. As long as they are not, the pathology of most reflex disorders will remain a biologic mystery.

Inasmuch as many reflex disorders are true conditions of auto-intoxication, the therapy of the latter, as indicated under the head of FUNCTIONAL DISORDERS, is applicable in their treatment. Frequently the so-called reflex disorders are produced by impulses received by the mind and the organs of special sense. The mind and the special senses are, as it were, receiving stations through which the nervous system communicates with the outer world. We know that the organism can be reached through these open gates by impulses addressed to the receivers and transmitted by them to the nervous system. It is plain that such impulses, if they are properly applied, can serve a therapeutic purpose. Therein lies the therapy of suggestion and of the different agencies which are capable of acting upon the sight and hearing and the other special senses.

Suggestion is unconsciously practiced by physicians at all times. It is the one all-important factor that makes or breaks a physician. Let him practice suggestion consciously and for a purpose, not only on the patient but on the patient's surroundings. The control of mind over mind primarily, and mind over body secondarily, is the one great psycho-physiological marvel in practical medicine. Inasmuch as the so-called reflex disorders represent a vast proportion of chronic nervous diseases, suggestion is necessary to control the subtle caprices of nerve-action that mark these reflex-disorders. That physical effects can be produced by suggestion, no one disputes. If it were not possible, the world would never have known anything of so-called miracles. The rest-cure, as advocated by S. Weir Mitchell, is a negative illustration of this subject. Absolute rest is enforced in order to put an end to untoward suggestive influences of surroundings.

The special senses can be acted upon for therapeutic purposes in the treatment of morbid reflexes. The suggestive influence of colors is undeniable. Whatever we see has color. The nervous system responds to these impulses. Experimentally it has been shown that, beginning with the thermic end of the solar spectrum, the red, orange, yellow, green, blue, indigo and violet radiations have irritating, stimulating, sedative and hypnotic effects, respectively, on the system. Color-effects can be added to the patient's surroundings in order to stimulate or quiet the nervous system. The adaptation of the means to the end will depend on the therapeutic requirements of the individual case. Morbid reflexes might be due to the effects of a certain color on the patient's eyes and skin. Charcot speaks of a lady who suffered from a nervous headache which would not yield. The headache became worse when the lady returned to her room, which was decorated with gay colors, red predominating. Charcot suggested to the lady to take another room, with blue wall-paper and plain furnishings. The reflex headache promptly disappeared. The same author speaks

of the advantage of gay colors in the treatment of certain forms of melancholia. (See chapter on THE THERAPY OF LIGHT.)

The skin is not infrequently the origin of reflex disorders. The case of a woman is recorded who suffered from enuresis whenever she wore woolen underwear. The enuresis was purely a reflex disorder produced by an irritation received and transmitted by the skin. The necessity of giving the skin some prophylactic and therapeutic consideration in the presence of obscure reflex disorders, is apparent.

The sense of hearing readily receives impressions that react on the nervous system. Therapeutically this has been demonstrated by the effects which sound is capable of producing on the human organism, both in conjunction with and independent of melody, harmony and rhythm. The therapy of sound (music) ought to receive more serious attention than has heretofore been accorded to it. Its availability in the correction of morbid reflexes has been amply demonstrated. It is not a question of attributing certain effects to a certain kind of music under any and all circumstances, although there can be no doubt that scientific experimentation will clear up much of the speculative nature of the subject. The character of the existing reflex disorder and the personal equation of the patient are important factors. A German neurologist was in the habit of administering to his hysterical patients suggestions in the form of suitable musical selections. One woman was suffering from a hysterical paralysis of the lower extremities. The acoustic therapy consisted in the daily rendition of a Strauss waltz played in the most fascinating and suggestive manner every two hours. After two days the spell was broken. The patient danced. In another patient maniacal manifestations were subdued by full chords played softly and slowly in a darkened room. A case of hysteria was relieved of dysphagia by the Sextette from Lucia and selections of a similar character. Music in these cases is the carrier of the

suggestive influence. Its availability and power in this capacity can only be appreciated by those who have had occasion to witness demonstrations of the efficacy of acoustic therapy.

The gustatory and olfactory senses are closely allied to reflex disorders. I know of a physician who attributes attacks of sciatica to the odor of certain drugs, notably pennyroyal. That the smell of certain flowers is capable of causing depression of the nervous system, even to the point of anesthesia, is well known. That the odors of some flowers, when inhaled by certain persons while asleep, may produce singular nervous phenomena in those persons after they have awakened, has likewise been observed. These effects are reflex disorders due to what appears to be a toxic condition of the nerves of smell.

Suggestions addressed to the nervous system through the brain or the special senses are agents of unquestioned power in the treatment of obscure reflex disorders. The therapeutic directions referred to are given in all seriousness. I am not unmindful of the fact that the subject of suggestive influence such as outlined above can not be formulated, analyzed and systematized in the strictly scientific manner which modern medicine expects and demands of therapeutic agents. Yet these suggestive agents have unquestioned power, even if the latter is ill-defined and oscillating. The worst that could be said in regard to them, holds good in regard to much of the drug-therapy of to-day with its uncertainty of physiological action and its ever-ready psychic efficacy.

Rheumatism.—That rheumatism is a disorder of metabolism and that certain predisposing conditions of temperature, climate, environment, diet, habits, etc., are capable of producing it, all physicians are agreed. Objectively it presents itself as the local expression of a general disturbance, or rather as a general disturbance with local expressions. The term "auto-intoxication" in its wide biological significance expresses the pathology of rheumatism perfectly.

It is of no consequence whether we look upon this disease as belonging under the acute infections. The pathology of the affliction teaches us that the outward conditions named above and the internal elements of disturbed metabolism are primarily concerned in the causation of the rheumatic state. That germs might develop under these conditions is not improbable; that toxins derived from germ-growth might add an element to the sum-total of the symptomatic evidences of the disease is quite likely. The essence of the disease process, however, is some disproportion in the intake of food and output of waste, using the latter term in its widest physiological sense. The disproportion arises from the retention in the blood of waste-products of oxidation and the formation and absorption of toxins from the retained excreta.

When, through any external agency or cause whatsoever, the nervous mechanism which presides over the assimilation of supplies and the expulsion of waste is disturbed so as to be unable to dispose of the ultimate derivatives of the tissue-building foods (principally uric acid and CO_2) and excrete them through the natural channels, the result is a retention of a part of these derivatives and their products in the system and a consequent condition of poisoning. These poisons may give rise to any number of toxic conditions depending on the manner in which they attack the organism or any special part thereof. Under suitable conditions this toxemia might present itself in a most tempestuous manner, characterized by hyperpyrexia and severe inflammatory phenomena on the part of certain structures which draw large quantities of secretion from the vitiated blood-fluid and become inflamed as a result (serous membranes of joints, pleura, peritoneum, pericardium, etc.). Why this selective action of the vitiated fluids of the blood should affect certain structures more than others is probably due to the fact that the number of lymph-glands is proportionately greater near joints, that the veins are tortuous in these regions and carry relatively more venous blood, and that, as a result, the effects of disturbed metabolism are more keenly

felt by the structures surrounding a joint. That the tissues concerned in the functions of motion (joints, muscles) should be more frequently the seat of rheumatism is easily understood when we consider the more active oxidation which is constantly taking place in these structures. The same reason might explain the liability of serous membranes to rheumatic irritation. They are functionally most active. This would be the etiology and pathology of the acute articular variety of rheumatism, or in a less severe and more protracted form, of chronic articular rheumatism. That these structures are readily affected by other kinds of toxins besides the derivatives of the tissue-building foods, is shown by the irritating action of gonorrhoeal toxins in the blood, manifesting their presence by the appearance of a gonorrhoeal arthritis (gonorrhoeal rheumatism) in the proximate joints. The toxemia might be of a comparatively mild type and show itself locally by affecting certain regions, muscles or other places of lessened resistance (muscular rheumatism, torticollis, lumbago, pleurodynia, etc.). The toxins may gradually accumulate and attack one joint or two (gout). In the latter condition the activity of gravitation is probably a factor of some importance. Both in muscular rheumatism and in gout the action of the direct, exciting cause may determine the character of the attack. Thus in a predisposed subject exposures to a draught might result in a local metabolic disturbance affecting the sterno-cleido-mastoid muscle and resulting in a stiff neck (torticollis). In another (predisposed) subject the indulgence in pleasures of the table might cause the disturbance of metabolism to explode in the big toe and produce an acute attack of gout. In a third individual the muscles of the back are sore (lumbago) as the result of exposure to cold. The cold draught causes contraction of the cutaneous vessels. The blood is forced into deeper tissues. Stagnation takes place in the deep tissues. Waste-products accumulate. The small nerve-filaments suffer from the want of fresh blood and are surcharged with an excess of $C O_2$. The result is the pain of

lumbago. If "reaction" had occurred after the forcible contraction of the cutaneous vessels took place in response to a draught, there would have been no stagnation, no accumulation of waste-products, no lumbago. The overtowering importance of "reaction" is clear to every thoughtful hydro-therapeutist. Why did not reaction set in after the blood had been forced into deeper vessels? Why did not hyperemia in the primary area follow? (See chapter on THERAPEUTIC EFFECTS OF HEAT AND COLD.) The presence of uric acid toxins in the blood has impaired the functional power of the local vaso-motor nerves. This is what is meant by rheumatic predisposition. It is the remote cause of the attack while the cold draught is the exciting cause. All this goes to show (1) that the various kinds of rheumatism are due to the same cause acting under different conditions, and (2) that success in the treatment of all rheumatic conditions is in direct proportion to our ability to restore the disturbed metabolism generally and locally. Since, however, the metabolic disturbance consists in deficient oxidation, it is plain that the rational treatment of rheumatism consists in intensifying oxidation and increasing the expulsion of waste.

In view of what has been said, we are prepared to look upon rheumatism in all its forms as being due to accumulation in, and absorption into, the system of waste-products. It is a common affliction of meat-eaters because of the inability of the organism to excrete the uric acid which is in excess. It frequently attacks persons whose circulation is poor. Stagnation of the intestinal excreta may produce it, as shown by the beneficial results of active catharsis in these cases. Not very many years ago an optimist declared colon-irrigation to be a specific in rheumatism. That it has a curative effect in selected cases, there is no doubt. Enough has been said to indicate the principles of rational treatment, to wit:

1. Forced excretion and expulsion of waste by powerful stimulation of the excretory organs;

2. Regulation of the physiological supplies to lessen or prevent waste-accumulation ;
3. Increased oxidation to help in the re-establishment of the physiological proportion between the burning of fuel and the expulsion of slack ;
4. To give symptomatic relief while the physiological treatment is in progress.

These directions, in a varied sense to meet individual requirements, hold good in all rheumatic conditions (acute and chronic articular rheumatism, muscular rheumatism, gout). Therapeutically the modes of treatment might be classified as general or local, according as they aim at correcting underlying systemic conditions or relieving local manifestations. For the sake of convenience it might be wise to consider gout and the muscular variety of rheumatism separately because they have characteristic clinical features of their own. The management of the inflammatory varieties (acute and chronic articular rheumatism) is practically identical. The advantages of the hospital or sanitarium, where all modern therapeutic aids in the treatment of rheumatism are available, are apparent.

ACUTE AND CHRONIC ARTICULAR RHEUMATISM.—In order to accelerate and intensify the expulsion of waste it is, above all things, necessary to open the bowels by repeated irrigation of the colon, or, if the patient can not be handled without causing great pain, by rectal injections. To flush out the kidneys, allow the patient to drink copious quantities of fresh, clear water. The latter direction holds good in all rheumatic cases. Water dilutes the offensive waste and helps in the excretion of the latter through the kidneys and through the skin. The sick-room should be light, airy and well-ventilated. Exposure of aching joints to sunlight was recommended as early as in the days of Hippocrates. The skin must be stimulated by suitable means. If the patient is totally helpless and can not be handled without great pain, a general hot moist pack can be applied. If the weight of the pack is not well borne by the patient, a hot vapor-

bath should be improvised as suggested in the treatment of exanthematous fevers. (See FEVER.) A bath of this kind can be given once or twice daily and may be followed by a pack if the patient stands the copious diaphoresis well. This is shown by the pulse and the respiration. Reduction of the body-temperature after each bath, and a general decline of the pyrexia after a series of baths, are good prognostic signs. If the patient can be handled, nothing equals the efficacy of the dry-heat body-cylinder. The object of a dry-heat bath in these cases is to cause diaphoresis and for this reason the duration of the treatment is of greater moment than the degree of heat employed. Ordinarily 200° to 250° F. for forty-five to sixty minutes are sufficient to produce a complete therapeutic effect. If the patient stands the treatment well, the so-called after-sweat will enhance the therapeutic effect. Ordinarily it is proper to rub the patient down with lukewarm water and add massage over regions which are not painful but are contiguous to the affected parts. Dry-heat baths are more trying to a rheumatic subject than vapor-baths and for this reason can not be as frequently administered. The same may be said of the electric-light bath, which is an agent of wonderful power in rheumatic cases, but must be used with great care and discretion. One of these dry-heat or electric-light baths can be given every day or two. If the weather permits; the patient will derive a world of good from a continued sun-bath.

In administering any of the powerful sweat-producing baths, it is wise to inquire into the medicinal treatment which a patient might have had previously. One of these baths is sufficient to cause acute symptoms of iodism or salicylic-acid poisoning if iodides or salicylates have been administered for a few days previous to the diaphoretic treatment. The latter seems to provoke accumulative effects of the drugs.

To lessen or prevent the accumulation of uric acid in the system, it is necessary to administer food which will help

in the oxidizing process without forming much slack. This makes the carbo-hydrates the ideal food-stuffs for rheumatics. Avoid meat, eggs, beans, peas, salt, pepper, mustard, all spices and highly seasoned foods, coffee, tea, alcohol in any form, in fact all foods that are not bland, light and easily assimilated. An excellent food as well as refreshing beverage, sanctioned alike by the advice of all experienced grandmothers and by the clinical records of dietetic institutions, is buttermilk. It can be given at all times and in any quantity, provided the patient's palate or stomach does not rebel against it. Water can be freely given. Sweet milk is an excellent food for rheumatics. On general principles the enforcement of a rigorous exclusive vegetable diet is indicated in all cases of rheumatism. The diet may include vegetable soups (except bean or pea), raw oysters, bread, oatmeal, toast, Zwieback, crackers, rice, milk-pudding, fresh fruit unless excessively acid, potatoes and occasionally, if the patient desires it, a cup of very weak tea, preferably without milk or sugar.

The dietetic regime of Schroth known as the "Trockenkur," has been successfully used in many cases of rheumatism. It is discussed under the head of SYPHILIS.

In the management of the local manifestations of articular rheumatism, *i. e.* inflamed joints, dry heat is admittedly the foremost therapeutic agent. A cylinder of suitable size is employed for this purpose. The patient is put in a comfortable position, the part or region to be baked is wrapped in three layers of Turkish toweling, introduced into the dry-heat cylinder, where it rests upon a hammock and the ends of the cylinder closed by means of hoods provided for this purpose. The hot air must not come in contact with any uncovered skin. Any part of the skin exposed to the heat must be properly covered as indicated above. The preparations being thus properly made, the heat is turned on. For local applications of this kind 300° to 450° F. are suitable and productive of much benefit. Treatments of this kind should last thirty minutes and longer. The physiological

effect aimed at differs most decisively from that of the general application in the body-apparatus. Stimulation of skin-function is secondary to the effects of intense heat *per se*. The object of the local application is to increase the arterial blood-supply and in this way to stimulate the venous and lymphatic circulation. In this way the local metabolism receives a most powerful impetus, the effect being a physio-chemical regeneration of the part. The whole region is heated up, the rise in the local temperature being coincident with more intense oxidation and tissue-change. The secondary effect of active diaphoresis helps to deplete the part and to diminish the amount of inflammatory exudates. The lessened pressure is experienced by the patient as a distinct relief from pain. Treatment of this kind can be given daily and even oftener. After the treatment the part should be allowed to rest for an hour, when it can be subjected to massage or any other additional treatment deemed necessary. The technique of dry-heat treatments is of the greatest importance. The occurrence of burns is most deplorable because it prejudices the patient against further thermic treatment. Burns of this kind are very stubborn. To prevent burning the toweling, the latter can be prepared by being immersed in the following solution which makes it fire-proof. The solution, which is recommended by C. E. Skinner, is as follows :

Thirty ounces of water in which enough tungstate of sodium is dissolved to make a saturated solution. To this add six ounces of water containing two ounces of phosphate of sodium. The toweling is soaked in this solution, hung up in an oven containing 350° F. until dry. The tungstate precipitate which remains in the fiber makes it fire-proof. Personally I know nothing about this process. With ordinary care thermic treatments can be given without untoward accidents. The electric-light bath is an adequate substitute for the dry-heat cylinder.

An hour after the thermic treatment, the affected area, if the inflammatory condition is comparatively mild, can be

subjected to kneading and centripetal massage. Vibration along the neighboring lymph-channels is of value. In acute cases the affected area should not be manipulated after the thermic treatment. Massage applied to the contiguous structures is permissible and beneficial. In a general way it might be stated that massage and electricity should be reserved for the subacute or chronic forms of articular rheumatism.

Galvanism may be advantageously employed in the subacute and chronic form of rheumatism. Place one pole on either side of the affected part (ten milliamperes for ten minutes daily). If the negative pole causes pain, place it at a distance. The affected part can be immersed in water, the latter being used as the conductor of the positive current. A static brush-discharge (wooden electrode) and the wave-current answer well in many cases. High-frequency currents have a fine effect on local metabolism. Some recommend cataphoresis of lithium salts (positive sponge saturated with a solution and applied locally).

After a joint has ceased to be painful, massage is of the greatest value. Deep kneading and centripetal stroking will do much towards restoring the part. Faradism is useful to tone up the muscles and prevent loss of muscular power. During the course of rheumatic inflammation of a joint many uncommon features might arise. Locally leeches, cupping, etc., may be required. Ice-applications are harmful. The rheumatic condition might involve other structures, especially the serous membranes. Treatment must be adapted to circumstances. At all times, however, the general regime, as suggested above, must be adhered to, and, if necessary, still more heroically enforced. The results of the physio-therapeutic treatment of rheumatism have robbed the salicylates of much of their glory as alleged specifics. The salicylates do not enhance the therapeutic effects of the agents spoken of, but frequently ruin the stomach and make a chronic case out of an acute attack. Coal-tar products are harmful because they deoxidize the blood by destroying the

hemoglobin and, therefore, aggravate the general state of the system which made the development of rheumatism possible. Least objectionable are the alkaline waters so frequently resorted to as anti-rheumatic remedies, although their therapeutic value is likely to be overrated. They are certainly not equal to the sulphate of magnesia, which by its dehydrating and cathartic action promotes the excretion of waste and the restoration of normal metabolism.

In the *gonorrhœal* variety of articular rheumatism the treatment would consist in dry heat locally, active peristalsis, vegetable diet, and suitable therapy to remove the real cause. Bier's stasis has been employed successfully in these cases.

Rheumatism (Muscular).—The principles of treatment do not differ from those underlying the therapeutic management of articular rheumatism. The greatest value is to be attributed to massage, heat and electricity. In all forms of muscular rheumatism the dietetic regime as outlined under the head of articular rheumatism must be rigorously enforced, the bowels must be kept open and, if the general condition of the patient indicates sluggishness, the dry-heat body-cylinder or the general electric-light bath should be resorted to.

TORTICOLLIS.—Effleurage over the aching stiffened muscle, first gentle and superficial, afterwards deep and firm, and followed by vibration, ought to practically cure the patient. If necessary the part can be exposed to the Minin light, the face and healthy part of neck having been covered with towels. The application of the wave-current or the static positive brush-discharge (wooden electrode) is beneficial. The galvanic current (positive to affected muscle, negative to other side of neck) or faradic current applied to aching muscle will remove pain and restore mobility.

PLEURODYNIA.—Treatment is the same as in cases of wry-neck. The larger the area of the affected muscular tissue, the more effective will be the use of the general treatment by means of a body-cylinder or electric-light bath. Locally the most remarkable results can be promptly

achieved by massage and vibration. Immobilization by adhesive straps is frequently of value.

LUMBAGO.—Local application of heat by a small dry-heat cylinder is an excellent anodyne and counter-irritant. Deep massage and vibration with due regard to the sensibilities of the patient should be judiciously added. The positive indirect static breeze, the wave-current, the galvanic current (positive pole to aching muscles) relieve pain very promptly. All positive applications should be combined with deep vigorous massage. Swedish movements to engage the lumbar muscles can be begun after the pain has disappeared. The cold douche to the lumbar region is excellent. Strapping the back by means of adhesive plaster is frequently required in the interval between treatments.

Rheumatoid Arthritis (Arthritis Deformans).—That this obdurate and destructive disease belongs under the head of true rheumatic afflictions, there seems to be no doubt. It is rheumatism in the trophic nerves of the joints and usually affects rheumatic subjects who have suffered frequent attacks of articular rheumatism. The trophic nerves, as a result of the rheumatic infection, are functionally impaired and perverted trophic (nutritional, developmental) processes take place in and near the joints. Some doubt the true rheumatic character of the etiology and point to heredity, frequent pregnancies, bad hygiene, psychic impressions, worry, etc., as causative factors in many cases. The prognosis, as far as the local condition is concerned, is bad because the cause is usually beyond reach.

Local treatment seems to be of no avail. Improve the patient's general health by sunlight, fresh air, exercise, open emunctories, mild but invigorating diet, etc. The body-cylinder is useful. General high-frequency treatments (cage or diasolenic) are very beneficial. Vibration and static sprays along the spine should always be resorted to. If the local symptoms require it, administer local treatment in keeping therewith and according to the directions which have been given under the head of articular rheumatism.

Salpingitis.—(See INTRA-PELVIC INFLAMMATIONS.) In the chronic form galvanism (positive pole in cul-de-sac near affected part, negative pole on back, ten to fifteen milliamperes for fifteen minutes every second day) is useful. General directions under INFLAMMATION (CHRONIC).

Sarcoma.—Negative electrolysis (multiple needle). (See INOPERABLE MALIGNANT DISEASE and chapter on X-RAY THERAPY.)

Sepsis (Local).—The treatment of an acute abscess or acute localized suppuration is to all intents and purposes a surgical problem. Abscess or localized pus-formations may be large or small. They may be diffused or circumscribed. They may be due to the activity of any number of pus-producers. Thus the local sepsis may be a stitch-hole abscess, a felon, a furuncle, a carbuncle, a suppurating bubo, an empyema. The predisposing cause of local pus-production should receive the first attention of the physician, *e. g.* the furuncle in diabetes, the suppurating bubo caused by a chancre. The location of the local sepsis determines to a certain extent the therapeutic indications.

ABORTIVE TREATMENT.—The formation of an acute abscess is always preceded by local inflammation. If the seat of inflammation is accessible, *e. g.* in the extremities, or comparatively superficial, heat is the proper agent to hasten pus-formation or to abort it by causing absorption of the inflammatory material. The small dry-heat cylinder, the hot-immersion bath, the hot moist pack, the Minin light, are serviceable for this purpose. If the seat of the inflammation is very superficial, the positive galvanic pole will often serve to abort suppuration, *e. g.* in furuncles. If heat ceases to give relief but rather increases pain, it is usually a sign that suppuration has already begun. The indications during the inflammatory stage are discussed under the head of INFLAMMATION (ACUTE) and FEVER. The impropriety of intensely cold applications to comparatively superficial inflammations is referred to under the head of APPENDICITIS.

POST-SURGICAL TREATMENT.—After an abscess has been

evacuated by incision, the rules of surgical cleanliness should prevail. It should be remembered that Finsen-rays or sunlight have powerful germicidal and restorative properties.

TREATMENT OF CHRONIC ABSCESES.—The contents of a chronic abscess gradually lose their infective character. For this reason there is no contra-indication to attempts to encourage absorption in many of these cases (massage of the contiguous tissues, stimulating hydro-therapeutic applications). If the abscess is open and directly accessible, it can be disinfected with chemical rays (sunlight, arc-light). To start reaction pack the cavity with cotton, moisten the latter thoroughly by allowing it to absorb water and place a wet negative sponge electrode over it, positive pole at a distance, allowing a mild galvanic current to pass for five to ten minutes. Remove the cotton and wash out the cavity. If the cavity oozes or bleeds, pack it with cotton, wet the cotton as before, but reverse the polarity, using the positive pole on the cavity. A high-frequency application to the surrounding part promotes absorption. (See INFLAMMATION (CHRONIC) for systemic therapeutic directions.) Tubercular abscesses in the extremities have been successfully treated by passive congestion (Bier's stasis). Additional information under ULCER.

Sex-determination.—The sex of an unborn child is not an accidental occurrence, but is determined by factors about which but little is known. Many observers seem to think that semen which has had time to mature will produce boys. Men who are temperate in their sexual life are more likely to have male offspring. Women who are in the open air and exposed to the chemical rays of the sun a great deal, are more likely to bear male children. Parents who are strong meat-eaters are not likely to be very prolific. They usually have but few children, mostly boys. A nitrogenous diet during pregnancy is supposed to favor the development of boys. (Darwin, Brehm, Finsen, Schenck and others.) Conception during the last half of the inter-menstrual period

is supposed to favor male offspring. The Mosaic law forbade coitus for seven days after menstruation. This seems to explain the greater proportion of male children among the Jews.

Sexual Weakness.—If the condition is a part of a general neurasthenia, treat the latter. (See NEURASTHENIA, HYSTERIA, FUNCTIONAL DISORDERS.) Suggestion is a powerful therapeutic agent. Locally the ice-cold catheter (reflux without bladder-opening) is useful; also steel sound connected with weak negative galvanic current, positive to the back or feet. Vibrate perineum and lumbar region, cold douches to the spine, especially lower end. Static sparks to perineum and spine. Vacuum treatment of penis, followed by faradization of the organ. Sexual abstinence must be enjoined in every case. Average duration of a daily electrical treatment should be ten to fifteen minutes.

Singultus (Hiccough).—Cold douches to the upper spine, galvanization or faradization of the phrenic (side of neck below ear to epigastrium), vibration over epigastrium. Deep inhalation while deep pressure over epigastrium is being made. Forcible dilatation of the anal sphincter sometimes interrupts an attack. Faradism (stomach to back) is serviceable.

Skin-diseases.—Disorders of the cuticle *per se* are always parasitic in character (scabies, pediculosis, tinea tonsurans, sycosis, tinea circinata, favus, etc.). In these diseases the skin itself is the seat of the disease-process attributable to a specific cause which is located in and active in the skin.

Disorders of the skin which represent some disturbance of nutrition, development or function and are not due to the presence of an animal or vegetable parasite in or on the cuticle, are always symptomatic of, concomitant with or consequential to irritation elsewhere. In a few instances this irritation results from the activity of external causes (the use of irritating cosmetics, soap, wearing apparel, bedding and the lack of cleanliness). In the vast majority of in-

stances, however, the irritation acts from within. Some nutritional (metabolic) disorder of the organism or some part of it is the cause, disease of the skin is one of the effects. The skin is the place where the metabolic disturbances may explode. The physiological importance of the skin, its position anatomically as the protective cover for the whole body, its importance as an excreting organ, its function as the seat of the tactile sense, its share in the heat-control of the organism, its close relation to the respiratory function, its intricate structure, all these factors give the skin a position of singular prominence in the economy. It is not surprising, therefore, that the physiological weal and woe of the system or any part of it should find sympathetic and symptomatic expression in the skin. The vast majority of the so-called skin-diseases are not disorders of the cuticle *per se*, but are only the outward showing of something that is wrong within. Under this head are included all the exanthematous manifestations, the different forms of erythema, the varieties of eczema, the disorders of the sweat-glands, of the tactile corpuscles (pruritus), all inflammatory and catarrhal affections of the skin, all hypertrophies, pigmentations, atrophies and new formations of the skin and any of its component parts. It is plain, therefore, that nearly all of the so-called skin-diseases are merely symptomatic. Local treatment is frequently futile. Recurrences are common. The reason is that the physician has treated a symptom and not the condition causing it.

PARASITIC SKIN-DISEASES.—The treatment of all these true diseases of the cuticle consists in the destruction of the parasite that represents the true cause of the disorder. If the parasite belongs to the animal kingdom (*e. g.* the acarus scabiei, the pediculus) it should be poisoned just as the larger varieties of parasites, *e. g.* roaches, bedbugs, rats, etc., are gotten rid of by poisoning. Mercury, sulphur and other chemicals serve an excellent purpose as parasiticides.

If the parasite is an anærobic organism (*e. g.* in the different forms of tinea) the simplest plan of attacking it, is to

make its habitat (skin) uncomfortable by improving the quantity and more especially the quality of the blood-supply of the skin. Oxygen is the parasiticide *par excellence*. It should be carried to the part by the blood and by the air. To keep diseased patches of skin constantly covered, is, therefore, manifestly unhygienic. The very fact of a vegetable growth developing in the skin, proves the lowered vitality of the latter. This is seen in cases of diabetes where, as a result of the suboxidation of the whole system, the skin is in poor condition and furnishes a splendid soil for the growth of pus-germs (furuncles). The same may be said of pustular acne, which is always associated with disturbed states of general nutrition. In all these and similar conditions the first duty of the dermatologist is to regulate the organism at large in keeping with the general laws of physiology and hygiene. (See chapter on PERSONAL HYGIENE.)

The local treatment of these skin-lesions due to vegetable parasites should consist in the application of such agents as impair and suspend the vitality of these germs. Sunlight, Finsen-rays, X-rays and high-frequency currents have a directly germicidal effect and are, therefore, applicable in all these conditions. The rationale of these agents and the technique in applying them are discussed in several chapters in the first part of this book. A classical example of this form of medication is Finsen's application of concentrated chemical rays in cases of lupus vulgaris.

NON-PARASITIC SKIN-DISEASES.—These disorders are all symptomatic. To understand the physiology of nutrition under altered conditions of metabolism and the effects of such alterations, see FUNCTIONAL DISORDERS, REFLEX DISORDERS, DYSPEPSIA, CONSTIPATION, SYPHILIS, and the chapters on PERSONAL HYGIENE and DIETETICS. From this strictly physiological point of view there is no scientific place for dermatology as a regional specialty. The symptomatic character of skin-diseases is well illustrated in the herpes labialis of acute fevers, the acne of puberty and pelvic dis-

orders, the urticaria of dietetic errors, the pigmentations of pregnancy, the eruptions of syphilis, etc., etc.

In attempting to treat any case of non-parasitic skin-disease, identify the etiological factor, if such is possible. If the identity of the cause is not quite plain, generalize your efforts by bringing the organism as near the physiological criterion of perfection as possible. Regulate all its functions, remove nutritional disorders and correct the habits and the surroundings of the patient. The dietetic habits of the patient are of the utmost importance. Spices, salt, pepper, vinegar, nutmeg, olives and similar substances are not infrequently the cause of pimples, eczema and other skin-troubles so annoying to the young woman whose happiness would be complete if it were not for those terrible pimples, facial blemishes, etc. These patients go from one dermatologist to another, take one quack-medicine after another and become disgusted with medicines and medical men. Schroth treated all skin-diseases dietetically and hygienically and cured the chronics who had run the gauntlet of skin-specialists and skin-clinics. The one great fundamental law in the treatment of non-parasitic skin-diseases is: Treat the whole patient principally and the affected skin incidentally!

The local treatment is suggested by the special features which the individual case presents. In syphilitic cases local treatment of the manifestations is unnecessary and even harmful. (See SYPHILIS.) Having ruled out the causative activity of external agencies (soap, cosmetics, filth, irritating clothing or bedding, etc.), examine into the changes which the skin is undergoing or has undergone (destruction or loss of tissue, inflammatory reaction, catarrhal condition, hypertrophic changes, atrophy, malnutrition, new formations, etc., etc.). Notice functional disorders (sensation, secretion). If there is an actual destruction or loss of tissue, apply the principles given under the head of ULCER. If there is hyper-nutrition, adopt antiphlogistic measures. If nutrition is sluggish, stimulate. If there is new devel-

opment, destroy it and create a healthy surface or bring about a natural reaction (absorptive process, retrograde metamorphosis). Act upon the affected area through the blood-vessels and lymphatics of the surrounding tissues by heat, negative electric modalities, vibration, centrifugal massage, etc., if you wish to stimulate; or by cold, positive currents, centripetal massage, if you desire to depress local reaction. Priessnitz cured a case of eczema rubrum of the foot by cold applications to the whole thigh. I know of a case of dry eczema of the hand which was cured by a masseur who confined his manipulations to the arm. Vibration of the neighboring lymphatics frequently starts a powerful reaction in an affected patch of skin. The Minin light causes intense hyperemia of the superficial parts and is indicated in the treatment of skin-troubles caused by and associated with local malnutrition.

The following list of the more common afflictions of the skin with therapeutic suggestions as to local treatment will be found convenient for ready reference, the therapeutic agents being named in the order of their efficiency:

Acne rosacca.—X-rays. Finsen-rays. Negative electrolysis for destruction of connective tissue. Positive electrolysis for vascular nodules.

Acne vulgaris.—X-rays. Finsen-rays. High-frequency. Minin rays. Positive electrolysis.

Comedo.—Negative electrolysis. Minin rays.

Eczema (chronic).—High-frequency. Negative static spray. X-rays. Galvanism.

Herpes.—High-frequency. Positive static spray.

Hypertrichosis.—Negative electrolysis by means of needle.

Keloid.—Negative electrolysis.

Keratosis senilis.—Remove by knife and X-ray the base.

Lichen planus.—High-frequency. Static spray.

Lupus erythematosus.—High-frequency. Piffard rays. Finsen rays. X-rays. Minin rays.

Lupus vulgaris.—Finsen rays. X-rays. Cupric electrolysis. High-frequency.

Pruritus.—Static spray. High-frequency. Positive galvanic application. X-rays.

Psoriasis.—High-frequency. Finsen rays. Cupric electrolysis. X-rays.

Scleroderma pigmentosum.—High-frequency. X-rays.

Sycosis.—Finsen rays. X-rays. High-frequency.

Tinea circinata.—X-rays. Finsen-rays. High-frequency. Negative static spray. Cupric electrolysis.

Spasm.—Heat (bath, hot pack, Minin light) is the most useful anti-spasmodic. If the extremities are attacked, a tight bandage above the contraction will be effective. Local mild faradization is useful. Alternate thermic shocks (hot and cold douches) are frequently effective. All anodynes have an anti-spasmodic effect. (See PAIN.) Spasm may be symptomatic. (See FUNCTIONAL DISORDERS and AUTO-INTOXICATION.)

Sprains.—Sudden injury to the soft tissues surrounding a joint due to a twisting or wrenching of the latter is attended by a severe reaction, pain, swelling, impairment of motion. Recovery after sprains is usually slow and not infrequently incomplete unless means are adopted to cause rapid absorption of the swelling and to restore the part functionally. Experience has shown that the application of intense dry heat (baking in a thermic cylinder of suitable size) is the proper therapeutic method to insure a quick result in these cases. The pain is promptly relieved and the process of repair inaugurated, leading to a good result in a few days. The treatment should be given every day for one hour with a temperature of not less than 300° F. In severe cases two treatments daily might be required. After the treatment the patient should rest for an hour and then receive gentle centripetal massage. To accentuate the local reparative effort, alternate applications of hot and cold water should be given once or twice daily and these again

followed by massage. The indirect negative static spray is useful as an adjunct in the treatment. A mild galvanic current with the positive pole near the point of greatest swelling and pain might be advantageously used for ten minutes every day. The local electric-light bath and the use of the Minin apparatus have been found serviceable as substitutes for the dry-heat cylinder, although the latter is undoubtedly more uniformly effective. The heat-treatment can be enhanced by local sun-baths given in the interval between the treatments. In chronic or neglected acute cases the regime is practically the same as in the acute variety. Vibration, stimulation and static sparks are useful unless pain interdicts their employment. Active and passive movements can be practiced. The old way of resting and immobilizing the affected part has justly become obsolete. Bier's stasis might be used in old painful cases. Massage should be added.

Stenosis.—The narrowing of any canal (*e. g.* the cervical canal), if it is due to changes (*e. g.* cicatrization) in the walls of the canal itself is best treated by negative electrolysis. The technique is analogous to that given for the electrolytic treatment of urethral structures. (See NEGATIVE ELECTROLYSIS, Part I of book.) The current strength and duration and frequency of treatments must be adapted to the conditions found.

Stiff Joints.—(See RHEUMATISM and RHEUMATOID ARTHRITIS.) Therapy consists in local dry-heat treatment, massage, passive movements, vibration, oscillation, static spray or sparks. If ligaments are contracted, cure is doubtful. If stiffness is due to disuse, local malnutrition, inflammatory exudates, adhesions, treatment should be persisted in.

Stricture.—The treatment of the structural narrowing of any canal is by negative electrolysis (negative pole of a galvanic current in the strictured canal, positive pole on the outer skin near by), the character of the stricture and of the canal determining the size and kind of electrode, the frequency and duration of treatments and the strength of

current. The technique is a suitable modification of Newman's method described in the chapter on THE THERAPEUTIC USES OF ELECTRIC CURRENTS. Put suitable electrode in place, turn on current slowly, bear down on electrode gently until the instrument passes through the constricted portion twice, turn current off slowly, remove electrode. Average duration of treatment is five to ten minutes, average strength of current is five milliamperes. Repeat electrolysis every four days with a slightly larger electrode until stricture is removed. Be sure to get the right kind and size of electrode. This method is applicable in cicatricial strictures of the male or female urethra, of the Eustachian tube, the lachrymal canal, the œsophagus, the cervix, the uterus, the rectum and the nares. Cleanliness is of the greatest importance.

Strictures of the Male Urethra.—Negative electrolysis (See Part I of book).

Sunstroke.—The majority of cases of insolation are cases of heat-exhaustion. This condition is brought on by exposure to excessive (solar or artificial) heat and is characterized by great depression of all the important functions of the organism. There are some lowering or elevation of normal temperature, weak and rapid pulse, quickened breathing, pallid and cold face, partial or total loss of consciousness. The patient may suddenly feel ill, be seized with convulsions or tremors and fall unconscious, rapidly developing the symptoms named above. Very few cases are true cases of meningitis or of acute sunstroke. The latter condition is marked by its sudden onset, coma, delirium, convulsions, paralysis, labored respiration, rapid pulse and, above all, a rise of temperature up to 110° F. and even higher. All metabolic function ceases, the albumen of the blood coagulates and the patient dies. These cases are rare. Nine out of ten heat victims that are picked up on the streets during the summer months and carried to the hospital are sufferers from heat-exhaustion (heat-prostration) and not sunstroke. This is shown by the large number of recoveries.

Recovery is the rule in heat-exhaustion, while it is the exception in sunstroke.

The treatment of heat-exhaustion is suggested by the physiological laws that underlie the heat-regulation in the organism. There is a temporary impairment of the vegetative functions. The machinery of metabolism is working under lower pressure, excretion—for the moment—is at a comparative standstill, toxins are taken up into the blood. The object of the physiological treatment is to give the organism a chance to get rid of the accumulating heat and products of oxidation. The skin must be stimulated. In this way the radiation of stored-up heat-energy is facilitated and excretion started. Massage and any kind of moist or dry, warm or hot application over the general body-surface are the proper agents for this purpose. The patient can be treated in the dry-heat cylinder, the electric-light bath, a warm bath or by means of moist or dry packs. Friction of the skin should be added. Diaphoresis must be enforced at all hazards.

The employment of ice-cold water or even ice-applications in the treatment of these cases is contrary to all laws of physiology and lessens the chances of recovery by closing the pores of the skin and thus blocking the avenues of excretion and elimination. If patients recover under these circumstances, it is not because of the treatment but in spite of the treatment. This statement is made with all possible emphasis in view of the treatment which is *en vogue* in many of the public hospitals where to the danger of heat-prostration are added the equally great dangers of an unscientific and inhumane therapy.

In addition to the application of external heat, warm drinks and stimulants should be administered. The colon should be irrigated and the patient given the benefits of the best hygienic surroundings. The head should be kept low and cool. After diaphoresis has been started, the patient can be stimulated by faradism or galvanism (bath or application to the spine).

Heat-prostration, heat-exhaustion and sunstroke (insolation) represent different degrees of the same affliction. True sunstroke is comparatively rare. It is characterized by its tempestuous onset and by the high temperature which ranges from 100° to 110° F. The heat-centers as well as the centers of respiration and circulation are overstimulated until they are exhausted and paralyzed. Immersing the patient in ice-water is supposed to reduce the temperature which threatens to disorganize the tissues. It is doubtful whether the chilling of the body-surface and the complete suspension of skin-function are physiologically indicated. Vigorously rubbing the patient with ice and douching the spine with cold water are undoubtedly the better methods because they antagonize the hyperpyrexia and at the same time whip up the lagging vital powers in a most pronounced manner. This is apparent in the changes which take place in the respiratory movements and in the circulation. The temperature drops and the regime indicated in the treatment of heat-prostration should be instituted. At all events, sunstroke in its pronounced severe form is rare. The prognosis is usually unfavorable. In arriving at a diagnostic conclusion concerning the various degrees of heat-prostration, the thermometer in the rectum should determine the exact grade of severity. The more tempestuous the onset, the graver the condition of the patient. Respiration is usually quick and superficial in mild cases, stertorous and labored in the severer cases although this is not an invariable rule. Lost reflexes and complete muscular relaxation are bad signs.

Superfluous Hairs.—Negative electrolysis (see Part I of the book), X-ray exposures produce a temporary effect.

Syphilis.—Lues is a toxemia of long duration and variable symptomatology. Three distinct stages are recognized, to wit: the primary (hard chancre, initial lesion), the secondary (eruptions, throat-symptoms, etc.), the tertiary (lesions of bones, nerves and organs of special sense). The tertiary stage is seen in unusually severe cases of syphilis and in cases that have undergone the wrong kind of thera-

peutic regime. The virus of syphilis through ages and generations of inoculation and through more perfect hygienic surroundings and habits of people, has become very much attenuated. It is comparatively rare to see a severe case of syphilis nowadays. Syphilitic patients, as a rule, suffer more from mercurialization than from the disease in the treatment of which mercury is supposed to be the specific remedy.

The rational therapy of syphilis was first taught and consistently practiced by Johann Schroth. It is the elaboration of the principle that the innate restorative power of the organism (*vis medicatrix naturæ*) is amply able to take care of the body if given the proper chance. Nature absorbs and eliminates the syphilitic toxins, unless the organs of absorption and elimination are unable to do the work. The objects of treatment, therefore, are—(1) to keep the glands in as active a condition as possible, (2) to preserve the functional integrity of the eliminative organs (emunctories), and (3) to improve the resisting power of the whole system. The therapy practiced by Schroth aims at the accomplishment of this triple object. The enormous experience which Schroth and his pupils gathered in the treatment of syphilis has never been equaled by any man or any school.

As soon as the existence of syphilis has been ascertained, the patient is subjected to a dietetic regime by which the system is compelled to accelerate the metabolic changes. The amount of liquids consumed is gradually lessened. The patient is put on dry carbo-hydrate diet, consisting principally of stale bread, rice and some fresh fruit. Every other day a glass of cider is allowed. Milk, coffee, tea and beer are absolutely excluded. It is understood that a rigorous dietetic regime of this kind can not be instituted abruptly. Two weeks or more are consumed in paving the way for this diet which should be consistently followed out for fully two weeks, when the patient is again allowed to slowly and gradually return to a more liberal diet. The effect of this dry diet (*Trockenkur*) is a veritable revolution

in the metabolic functions of the organism. Oxidation, in this case properly called self-consumption of the organism, becomes so intense that the temperature rises two and even more degrees above the normal. The system is literally devouring itself.

The effect of this self-consumption is accentuated by stimulation of the emunctories. The vapor-bath or the dry-heat cylinder is called into requisition twice a week to open up the pores of the skin and help in the process of forcible dehydration. The colon is irrigated every day or two. In addition to all this the patient is given the advantages of perfect hygienic surroundings, fresh air, sunlight, freedom from care and the suggestive influence of the physician's hopefulness. The external evidences of syphilis are in no way interfered with. The syphilitic lesions of the skin and the plaques on the mucous surfaces are distinctly efforts of nature to eliminate toxic material and should, therefore, not be interfered with. Absolute and painstaking cleanliness should be the only agent used in their treatment. Use water as a mouth-wash and as a general cleansing agent and some bland powder (rice-powder) as a dressing on skin-lesions, if they should require a dressing. Schroth never interfered with discharges of any kind. He looked upon them as being eliminative and, therefore, salutary. In his eliminative efforts he used great caution born of experience. He reasoned that too forcible elimination would result in fatigue and eventual exhaustion of the eliminating organs (glands). After six weeks of dry diet and eliminative procedures Schroth allowed his patients a liberal non-stimulating diet (mostly fruit and vegetables), but no alcoholic drink except cider. A sweat-bath every three or four days, open bowels twice a day, and otherwise perfect hygiene were the features of the after-treatment. The patient whose weight went down considerably during the six weeks of active treatment, soon regained his former weight. In some cases another "Trockenkur" was given after two or three months.

These are the gross features of Schroth's method. It is unnecessary to say that it is a most severe ordeal for the patient while its rationale and its results are unquestioned. The sensation of thirst becomes an unbearable torment and requires unusual will-power and endurance on the part of the patient. A milder regime patterned after Schroth will have to be adopted in most cases. If it is too mild, it is worthless. The results under Schroth's treatment were so uniformly good and so surprisingly prompt that his contemporaries at the University of Vienna could not help admitting the value of dietetic directions in the treatment of syphilis. Schroth persistently refused to treat any one who had had mercurial treatment. "Mercury has a selective action on the glandular system or rather on the trophic nerves which control the functional activity of the glands, especially those of the salivary and pancreatic glands. In very small doses it stimulates the action of the glands." If continued, the parotid glands and the pancreas soon show the effect of overstimulation while the glandular system at large merges into a condition of lethargy. It is very difficult to make a mercurialized patient sweat. Such a person suffers a great deal from the cold in the winter, always has cold skin and especially dry, cold hands, and presents in his whole physical make-up the evidences of seriously impaired metabolism. For this reason Schroth objected to applying his method to persons who had taken mercury.

The results of mercurial treatment are neither uniform nor are they always favorable. The disappearance of syphilitic manifestations after mercury is easily accounted for by remembering the inhibitory effect of mercury on glands generally and the resulting impairment of metabolism. The cases drag along for years and suffer more from the damage done by the treatment than by the disease. After a variable length of time the glandular function reasserts itself and an unexpected manifestation of an old syphilis is the result. This is notoriously the case in mercurialized patients. The stubbornness of syphilitic glands in mer-

curialized patients is in strange contrast to the statement made by Schroth that enlarged glands in syphilis are the exception rather than the rule. Fortunately the belief in the specific action of mercury in syphilis is not by any means as general as it was twenty-five years ago. Under dietetic regime the manifestations of syphilis are quicker to appear, more pronounced and more prompt to disappear permanently.

The treatment of a fresh case of syphilis should be begun as soon as the diagnosis has been definitely made. A mild dietetic regime, patterned after Schroth, should be instituted. The dry-heat cylinder should be used every four days. Irrigation of the colon should be practiced daily. The patient should have perfect hygienic advantages and be taught to be absolutely clean. Therapeutic measures to improve the general health (general high-frequency treatments, static spray, vibration along the spine, cold douches) are very useful. In a series of twelve cases of acquired syphilis I have seen eleven perfect recoveries. One case acted badly and seemingly went from bad to worse until he finally passed from my notice. He came to me from a Western health resort which is a Mecca of people who worshiped well but not wisely at the shrine of some infected Venus. The man had had the stereotyped inunction-treatment and had improved while under mercurial treatment, at least as far as the outward signs of the disease were concerned. This is usually the case on account of the effects of mercury noted above. One of the cured cases I treated in 1898 in strict accordance with Schroth's plan. The man had a typical case. After six months he passed from notice. In 1903 he reappeared only to show what a magnificent specimen of physical manhood he was. He had married in 1899. His wife gave birth to two healthy children.

There is no doubt in my mind that the action of mercury in syphilis is simply a matter of faith and habit, not of conviction, with most physicians. It is the *ex cathedra* teaching of a few eminent syphilographers. The average phy-

sician does not see enough of syphilis to be able to judge for himself. If he did, he would soon realize that most syphilitics recover in spite of mercurial treatment and not on account of it. The healing power of nature is equal to the double task of fighting the ravages of treatment and disease. There is less objection to potassium iodide on this score. However, it impairs digestion and produces accumulative effects. The latter should be remembered in giving dry-heat treatments. If a patient has taken K I for a few days, one thermic treatment at times is capable of causing acute iodism. In conclusion I wish to state that the initial lesion of syphilis reacts favorably upon the concentrated chemical rays. The application should be made daily and be followed by a Minin exposure. The treatment of bubo does not differ from that in any other kind of localized glandular inflammation. The syphilitic bubo but rarely suppurates, while the chancroidal bubo usually does.

Tetanus.—Haufler reports a case of traumatic tetanus which was cured by dry-heat baths, general packs and sunbaths.

Therapy of Rest and Recreation.—The principles of this most important form of physio-therapeutic medication are indicated in the chapter on PERSONAL HYGIENE and elsewhere. Rest is to counterbalance work, using both terms in a physiological sense. Recreation equalizes the output of energy by exercising physical or mental forces that have been unengaged while other physical or mental energies have been at work. Rest means the absence of effort, recreation is a change of effort. Both meet vital requirements of the organism and have, therefore, a deep therapeutic significance. Their application in the treatment of diseased conditions offers a vast field for physiological and psychological reasoning.

There is no difficulty in understanding the meaning and purpose of *rest*, because the significance of *work*, physical (muscular, mental) and physiological (organic, functional), is plain. Recreation as a therapeutic factor is not so easily

interpreted and made subservient to a therapeutic purpose. Practical methods by which suitable recreations are to be selected to meet the requirements of special conditions, according to W. J. Herdman, vary as taste, occupations and opportunities vary. From the complexity of occupations in which people engage there results the greatest variety of channels through which the store of nervous energy is depleted. Outdoor plays and games, requiring some skill, such as boating, fishing, swimming, skating, horseback riding, gardening, tool work, and the like, are of much more recreative value than any of the artificial gymnastics which have no purpose nor incentive beyond the movement itself. For the brain worker the way is open to innumerable recreations, and the opportunity for choice and the possibility of varying their character at will, make the problem of healthful living an easy one if any man would but cultivate a sufficient variety of interests, so that when one channel of activity was for any reason closed to him, as a relief from necessary work, he had but to choose another. The practical result in this is seen when the statistics of health and longevity of the brain worker and of the muscle worker are compared. The researches of Beard and others had shown that brain workers not only lived from fourteen to twenty years longer than muscle workers, but that their health was more uniformly good and their stature of larger average. When mankind is once emancipated from the conception that honest work is contemptible drudgery, and learns to recognize the pleasures and recompense it has in store when rightly apprehended, which means that the work selected must be suited to individual capacities and tastes, and when greed and selfishness give place to a spirit of mutual helpfulness, the problem of recreation—from a social, economic, sanitary and therapeutic point of view—will be solved. (Herdman.)

Some authors consider the primary and predominant factor in practically all forms of recreation the *psychic* one. Although the influences of the mind over the body are

recognized in a general way, they are fully comprehended by comparatively few. The sudden change from a state of extreme depression and misery, with perfectly distinct physical suffering, to one of buoyancy and exultation, with entire forgetfulness of self as a result of a change of emotion, is a not unfamiliar experience in the lives of most people. As an illustration of the broad effects of mental impression in general, G. W. McCaskey mentioned the case of an attorney under his observation, whose digestion after considerable improvement remained more or less distressing in spite of all he could do for his relief, which included the treatment of a local stomach disease by suitable methods, careful regulation of diet, gymnastics, and a liberal amount of outdoor exercise. This gentleman would go to a little lake forty miles away, and the very first meal that he would eat there, long before there could be any possible effect of exercise, atmospheric change, etc., would be digested without the slightest disturbance or even consciousness on his part, and this would continue until his return to the city, when the old conditions would be immediately resumed. If the various forms of recreation were closely scrutinized, it would probably be found that those diversions and amusements which produced the promptest and most brilliant effects upon both the mental and physical states of those who participated were precisely those in which the psychic impression was the strongest. The first requisite in successful recreation is a complete diversion from self, a complete submergence of self-consciousness, which inhibits that everlasting introspection of our physical selves which is the foundation of half the morbidity of the world. How this can best be done in the individual patient is a problem for the physician to solve, and depends upon the age, sex, social status, intellectual development, and other factors which go to make up the complete *ego* of the patient. The physician must give thoughtful attention to the purely physical or mechanical aspects of many forms of recreation; in other words, to the factor of muscular exer-

cise, and to the systematic introduction into the lives of his patients of such recreation as is suited to individual needs. This should be a part of his therapeutic reasoning. A proper understanding of the physiologic laws and facts which underlie the whole subject could not be otherwise than helpful in the management of such cases as require no active treatment in the ordinary sense of the word, but a world of wise guidance. For the latter they naturally look to the medical adviser. McCaskey concludes his splendid exposition of this subject with the admonition of Virgil that "rural recreations abroad, and books at home, are the innocent pleasures of a man who is early wise." For additional therapeutic suggestions along this line see REFLEX DISORDERS and FUNCTIONAL DISORDERS.

Tobacco.—The use of tobacco may give rise to functional disorders of the heart and the organs of special sense (palpitation, precordial distress, vertigo, insomnia, disturbances of vision, sounds in the ears, sensation of heat, cold, tickling or formication in the skin, aberrations of taste, etc.). Stop the use of tobacco and give spinal vibration and negative static sprays. Every kind of stimulating treatment (cold douches to spine, sunbaths, etc.) is indicated.

Tonsillitis.—The acute attack requires cold moist packs to the lower extremities and a Priessnitz compress on the neck. Treatment of this kind usually aborts the attack. (See INFLAMMATION (ACUTE) and FEVERS.) Gargle with hot water. Negative electrolysis (needle) for broken-down follicles.

Chronic tonsillitis is usually a surgical problem. Metallic electrolysis (positive copper-electrode to tonsil, negative outside of neck) might be tried. Positive static spray to the neck, also high-frequency applications to neck or directly to the tonsil. (See INFLAMMATION, CHRONIC.)

The general treatment of an acute attack of tonsillitis applies to inflammatory conditions of the pharynx and larynx. "Derivation" to the lower parts of the body and to the surface is the essential part of the treatment. Keep

emunctories open. Chronic inflammation of the pharynx and larynx requires stimulation of the surrounding parts (neck, etc.) by massage and faradism. General hygienic directions are essential. (See INFLAMMATION, CHRONIC.) Vibration over cervical vertebræ, galvanism (positive pole as near as possible to affected region, negative pole to back of neck), positive static spray, high-frequency current, local electric-light bath, Minin light to front and sides of neck are useful.

Toothache.—(See NEURALGIA.) Dip cotton in 10 p. c. cocaine solution; put cotton in cavity of tooth and connect with positive pole of galvanic current two to five milliamperes for five to ten minutes, negative electrode to be held in the hand. Cataphoresis as described is useful as a temporary anodyne. Positive pole to aching gum, negative to opposite side of neck (galvanism) or positive static spray is very useful. If area is congested, "derivate" to the lower extremities.

Tuberculosis of Glands.—Treatment by means of X-rays has been referred to under the head of X-RAY THERAPY. Galvanism is useful (negative sponge electrode over gland, positive on opposite side of neck, etc., the object being to get the glands between the two poles). Twenty milliamperes or more for twenty minutes every other day. Bennett recommends potassium iodide by cataphoresis. Technique as above. High-frequency current locally (ten minutes every day) is useful. If inflammatory reaction is present, the Minin light is indicated. If the glands are in the extremities, Bier's stasis is available. Massage and vibration must be cautiously used on account of the danger of causing absorption and dissemination of tubercular matter. Tubercular glands are catch-basins in which the infectious material is collected and locked up to save the system at large. The object of treatment must be to kill the pathogenic factor (stasis, actinic rays, X-rays, high-frequency current) or to encourage disintegration and discharge externally (thermic rays, metallic electrolysis). In tuber-

cular glands metallic electrolysis is recommended by some. A small, thin, pointed piece of zinc is inserted through a puncture and a current of two to three milliamperes is allowed to pass for ten to twenty minutes. Superficial tubercular glands have responded favorably to prolonged applications of radium. In all cases of tubercular glands the general condition of the patient must not be lost sight of.

Tuberculosis of Joints.—In the non-surgical treatment of tuberculosis of joints, Bier's "stasis" seems to offer the most promising results. The rationale of the method was foreshadowed by Rokitansky as early as 1838. He called attention to the fact that "lung-consumption was never found in patients suffering from fullness of blood in the lungs." Frerichs in 1857 stated that consumption was common in diseases of the pulmonary artery (anemia of the lungs) but hardly ever found in cases of hypertrophy of the heart (hyperemia of the lungs). Applying the principle to joint-consumption, Bier induces venous hyperemia by placing a compression-bandage (rubber) above the affected joint. The bandage is applied in several turns of the rubber firmly enough to produce a moderate degree of blood-stasis below the bandage. There must not be any pain or great inconvenience connected with the application. The limb is held in a horizontal position. The bandage is left in position for several hours every day or every other day. The case must be carefully watched and symptoms met as they present themselves. The adoption of this method does not exclude ordinary means of maintaining surgical cleanliness. The advantages of immobilization, extension, derivating water-applications, counter-irritations by cups or leeches should under suitable conditions not be lost sight of. In favorable cases of joint-consumption associated with suppurating fistulæ, the tubercular abscesses eventually change into non-infectious cold abscesses. The discharge lessens gradually and finally ceases. At this stage effleurage and passive movements are indicated. After the fistulæ are closed, the joint is handled like an ordinary stiff joint. Ab-

sence of pain and swelling is a good sign of extinction of the tubercular process. Under the circumstances the use of the small thermic cylinder (baking) is advantageous, although Bier, even in these conditions, resorts to passive rather than active hyperemia. For this purpose the vacuum-apparatus is useful. The high-frequency current and the indirect positive (static) spray have a gentle stimulating effect in these cases. Vibration along the course of the lymphatics near the affected joint might be employed centripetally, mainly in conjunction with massage. Massage, local electric-light bath, faradization and the direct negative static spray or sparks are useful in restoring the whole limb functionally and structurally, after the joint has ceased to give rise to symptoms. X-ray treatment has been referred to in the chapter on X-RAY-THERAPY.

Constitutionally the patient should receive the benefits of fresh air, wholesome food, sunlight and skin-hygiene. In rheumatic and syphilitic cases the dry-heat cylinder or the electric-light bath should be called into requisition.

Tuberculosis Pulmonum.—No subject in clinical medicine has received as much study from all points of view as the "white plague." There is no disease that means so much to man in the aggregate as this murderous, insidious, omnipresent and ever-active foe of the human family. In spite of all that has been said and written about tuberculosis, the practical import of the subject can not be too often pointed out or too deeply impressed. When we consider that tuberculosis causes 50 p. c. of all deaths from five to thirty years of age, and that fully one-half of these cases might have been either prevented or cured, we can approximately estimate the immensity of the subject and the inadequacy and the comparative futility of the efforts which have been made to combat this foe. It is impossible to realize the material, economic, social, moral, intellectual and sentimental loss which mankind sustains as the result of the disastrous activity of the white plague. Compared to this loss all other medical and hygienic problems pale into insignificance. **The**

solution of this problem should be uppermost in the minds of those who love mankind and who have the future of our country at heart.

The natural history of tuberculosis, as exemplified in the relative liability of certain ages and social states, throws considerable light on the prophylaxis and hygiene of the disease. J. F. Huber, of New York, in a statistical review of consumption, states that the mortality is lower for the married than for either the single or the widowed and lower for women than for men. Brandt finds that the only time when the death-rate is higher for women than for men is among the married between the ages of fifteen and forty-five years; and here it is also higher than for single women during the same ages. These data are in large part explained by the development of consumption as a sequel to exhausting and frequent pregnancies. The highest death-rate of all is among the widowers under forty-four years. After the forty-fifth year the rates for both widowers and widows, while higher than for the married, were lower than for the single. Hoffman observes that the death-rate among widowers is highest at the youngest ages, while lowest at the most advanced periods of life. The higher mortality of widowers at early ages is the result of disease-transmission from wife to husband. There would seem to be a lesser liability in the transmission of the disease from husband to wife; possibly because the husband is away from home a large part of the time, while the consumptive wife being so much more at home, infects the household the more. Widowers have a much higher mortality than widows at corresponding ages: at ages up to forty-four years, 67 against 36; from forty-five to sixty-four years, 49 against 19; from sixty-five years on, 31 against 21. The high death-rates among the single are largely due to occupations; to the fact that a far higher percentage of the single than the married live in cities, where the devastation is much greater than in the rural districts; and to habits of life detrimental to longevity, such as alcoholism, to which the single have more

temptation than the married. This last factor may tend also to explain the greater mortality among the widowed than among the married. And the favorable mortality enjoyed by the married is certainly due in large measure to marriage being inherently a process of natural selection toward which only the fit tend, and also to the greater regularity and soberness of living essential to matrimony. Particularly is this so of consumption, a disease which thrives upon irregularities and exposures.

In discussing the subject of lung-consumption and in considering the therapeutic agents which are at our command in the treatment of the disease, we must not lose sight of the two cardinal features of each and every case of this kind, to wit: the infection in and of itself and the soil which made the development of the disease-producer possible. The bacillus *per se* means nothing unless we consider it in conjunction with the necessary conditions which give it a chance to become the exciting cause of a consumptive process. The question of the treatment of tuberculosis would, therefore, resolve itself into the solution of two problems, viz.: How can we attack the vitality of the bacillus itself and how can we render its dwelling-place as uncomfortable as possible or practically uninhabitable? These two problems must be solved jointly. To wage war against the tubercle bacillus without rendering the soil sterile leaves the patient liable to reinfection. To give all our attention to the soil means to ignore the essence of the disease. In attempting to discuss some auxiliary agents which may help us in successfully overcoming the ravages of this murderous foe, their relative merits in a therapeutic sense can be best understood by considering them in relation to the double purpose of successful treatment mentioned above.

The question of rendering the bacillary cause of the disease inactive, or of destroying it entirely, suggests itself as the first step in the treatment of tuberculosis. The bacillus thrives in lungs which are badly nourished. The less fresh air and rich arterial blood find their way into any particular

part of the lung, the better the chances for rapid and prolific growth of the germ. The oxygen in the air and in the blood is the natural enemy of the bacillus. The first and most important therapeutic indication is, therefore, the necessity of pure oxygen-laden air. In order, however, to become a powerful therapeutic factor the air must have a chance to enter the lungs, particularly those secreted and distant portions where the bacillus has found lodgment and thrives. The tuberculous patient's respiratory movements are shallow and do not expand the lungs as they should in order to aerate the infected portions. Consequently it is of importance to adopt measures which will deepen the respiratory movements. To encourage the patient to breathe slowly and deeply, especially out-of-doors, is, of course, of great value. The effect can be many times enhanced if additional care is taken to develop the muscular cover of the chest and to render the bony framework more elastic. The skin of a consumptive does not functionate properly. It is inactive from anemia or ischemia and causes accumulation of toxic material within the system. At times nature makes a gigantic effort to counteract these states of auto-intoxication and the numerous incidental symptoms which are produced by toxemic conditions. At such times, especially while other organs are comparatively at rest, the skin becomes over-active (night-sweats). The skin, therefore, and through the skin the circulation, both qualitatively and quantitatively, should receive attention at the hands of the medical attendant. The fever-process by means of which the gradually succumbing organism tries to combat the advancing foe, fighting and disputing every inch of ground, must be intelligently directed into the proper physiological channel. Alimentation must be regulated in accordance with the biology of the disease. In keeping with the hygienic and therapeutic requirements of consumptive cases, it might be serviceable and will certainly aid in systematizing the practical part of the subject to give these physio-

therapeutic agents separate discussion in conjunction with the treatment of an average case of tuberculosis pulmonum.

MASSAGE OF THE CHEST.—In order to understand and appreciate the therapeutic value of massage it is proper to acquire the manual dexterity which alone enables us to form any opinion as to the possibilities of mechanical therapeutic methods. To manipulate the muscles of the chest-wall means to increase their blood-supply, to develop them, to render them stronger and more active. This, in and of itself, means more vigorous respiration, especially if the mobility of the thorax proper has been increased. These effects should be aimed at in all cases of lung-consumption, especially during the early stages. The *modus operandi* is subject to variation owing to peculiarities of individual cases. In a general way the following suggestions will be found applicable to most cases:

The patient being placed in the dorsal decubitus the operator begins the manipulation over the costal border, gently picking up between his fingers a fold of skin and subcutaneous tissue, lifting it from the bony structures beneath and gently kneading it between his fingers. Most patients will be found to be "hide-bound," the soft tissues of the chest-wall being very tense and hard to raise. Eventually, *i. e.* after repeated sittings, the fold of skin will come up with comparative ease. This manipulation requires all possible patience and gentleness. Lack of delicacy would be worse than worthless. Gradually the manipulation is extended over the whole chest. This form of massage may be followed by gentle stroking in a horizontal direction. Each sitting should last from fifteen to thirty minutes, to be repeated after twenty-four hours. Within a week or two the muscles of the chest will be less tense and probably a trifle fuller. At this juncture exercise of the thorax might be begun. The operator places his flat hand over the right or left side of the patient's chest, making firm and gradually increasing pressure. The result will be a partial im-

mobilization of a portion of the chest. If the patient is told to breathe deeply, the effect on the unengaged side of the chest will be more or less intense. The patient will expand the unengaged side of the chest more than he would without immobilization of the other side. The operator may alternately place his hand on one and the other side. He may vary the procedure by placing both hands on the lower portion of the thorax over the last three ribs, thus forcing the patient to expand the upper portions of the chest vigorously. In this way the expansive power of the chest can be increased considerably, rendering inhalation of fresh air a therapeutic factor of prime value. In applying these mechanical methods to individual cases, much depends upon the judgment and the individualizing faculty of the physician. With proper care and judgment an immeasurable amount of good may be derived from manipulations of this kind.

GENERAL MASSAGE.—In many cases of consumption, especially before much impairment of general health has taken place, the invigorating effect of massage adds much to the comfort of the patient. Considering its effect on the circulation and indirectly on the metabolic functions of the organism it is especially indicated in those cases in which weakness and marked exhaustion after comparatively little exercise or exertion are characteristic symptoms. Massage in these cases takes the place of muscular exercise and, if judiciously administered, is a very serviceable substitute. It should be given every day or two and never be carried to the point of irritation. Deep effleurage along the lymphatics of the extremities does well in cases in which symptoms of auto-intoxication are conspicuous, *e. g.* headache, muscular pains, fatigue, insomnia, etc. General massage in and of itself is often sufficient to relieve these symptoms. It frequently prevents night-sweats. Superficial massage should be avoided on account of its irritating effect on the skin nerves. All massage-movements in cases of this kind should be centripetal with a view of depleting the venous

and lymphatic vessels. If the tendency towards hemoptysis is well-marked, more than ordinary discretion should be exercised in the carrying out of any mechano-therapeutic measures.

HYDRO-THERAPY.—To increase the resisting power of the organism various hydro-therapeutic procedures may be resorted to. A cold moist pack (Priessnitz method) from the feet to the epigastrium given for half an hour every other day and followed by deep massage, is a splendid tonic. Patients treated in this manner usually sleep and digest well and are less liable to "catch cold." A Priessnitz pack applied to the whole chest relieves dyspnea and distressing cough. If the circulation is sluggish, a *hot* moist application is safer. The cold douche applied to the back and to the lower extremities stimulates the mechanism of respiration and prevents venous congestions in the thorax. In all these therapeutic applications the dosage as to duration, frequency and severity of treatment should be carefully adapted to the tolerance of the individual patient and regulated as the strength of the patient's organism increases. Partial packs and douches pave the way for packs and douches of the whole body. The general cold moist pack is excellent in cases with tolerably good circulation, a continued low fever especially towards evening and at night, and ill-defined symptoms of auto-intoxication. If there is a tendency towards edema and hemoptysis, a full bath (warm) or a *mild* treatment in the dry-heat cylinder or electric-light bath is productive of much benefit. If Priessnitz packs are well borne they should be given to certain regions of the body successively, changing the region treated from day to day: lower extremities, next day the back, then the abdominal wall and so forth. Every treatment should last at least one hour and should be followed by vigorous massage of the region treated. It should be remembered that the *cold* moist pack is the ideal application and should be used whenever and wherever possible. It is the tonic and alterant *par excellence*. If hot, warm or tepid applications have to be

substituted, it should be the medical attendant's aim to habituate and educate the patient's body so that eventually the cold applications and the reaction following can be made use of. Many times, of course, this will be a difficult task. The "derivating" method should be resorted to in cases of hemoptysis. A well-applied Priessnitz pack to the lower half of the body will stop lung-bleeding after styptics and heart-depressants have failed. If the patient is confined to his bed the cold sponge-bath is useful, followed by massage. Priessnitz packs to the feet for three or four hours have a sedative and even a hypnotic effect. To enhance the effect of a "derivating" pack a rectal injection of hot water before or after the pack is frequently serviceable. In suitable cases the use of the vapor-bath is not objectionable. It should be followed by a good dry rub and absolute rest. Swimming in the spring and summer is a therapeutic agent of the greatest value in these cases. It combines the advantages of cold water and reaction, light, exercise, fresh air and systematic chest-exercise. Niemeyer considers systematic swimming the best treatment for consumptives, especially if they can camp out and spend all their time in the open air without the encumbrance of clothing of any kind.

GYMNASTICS OF THE RESPIRATORY APPARATUS.—The tubercle-bacillus would give us little concern if the body of the consumptive patient did not offer a splendid soil for its growth and dissemination. The colonization of the tubercle bacillus on and in the tissues of the patient is preceded by a period of preparation during which the tissues gradually become a suitable habitat for the germ. The process of preparation begins with neglect of the lung-function. Inasmuch as imperfect lung-function may be conditioned by inherited bad quality of the body, its parts, tissues and fluids, it may be said that the process of preparation frequently begins in the preceding generation or still further back. A wretched physique, small, flat chest, poor blood and other evidences of physical inferiority may be the heritage of a human being in whom the sins of its fathers are thus being

avenged. Scrofula, tertiary or inherited syphilis, rachitis and many other conditions of bodily wretchedness are the punishment which nature metes out to those who sin against fundamental principles of hygiene. (See chapter on PERSONAL HYGIENE.) The offender may be an individual, a family, a tribe, a race. The sufferer may be another individual, another family, another tribe, another race. To save the species, nature gradually destroys the part. This is the biology of tuberculosis. Tuberculosis is not inherited *per se*, but all the conditions favorable to its development are. The moment the individual is born, the struggle for existence begins. If the weapons of defense are absent, the doomed victim of a progenitor's misdeeds succumbs. The fittest survives. Marriage is a crime against society if one or both of the contracting parties are consumptives or otherwise physically or mentally inferior. It should be prevented by law. This phase of the subject is a hygienic and economic problem which should be solved *now* so that the countless unborn in the bosom of the future may live. It is a problem that will never be solved unless man in the aggregate returns to first principles of hygiene. This would be the crowning effort of civilization in its most exalted sense.

The habitat of the tubercle-bacillus is not always inherited. Sometimes it is acquired or even assiduously cultivated. The surroundings, the habits, the occupation of an individual may prepare a suitable soil. Lung-function may be neglected, resulting in a corresponding atrophy, shrinkage or degeneration of the lung and its container, the bony frame-work. The result would be deficient oxygenation of the blood and a corresponding deterioration of the quality of the whole system. The diminution of the amount of oxygen assimilated by the lungs leads to a gradual lessening in the number and quality of the red blood-cells. Thus the resisting power of the system is constantly waning. Alcoholism and other bad habits may add their share to the general collapse. The soil is ready for the crop of hungry

scavengers that are being carried in with every breath. The battle for existence has begun.

In these cases of incipient phthisis the therapy should begin at the seat of the trouble. The lungs should be developed, the chest-wall be made to expand, the organism should receive its physiological share of fresh healthy blood. This can be accomplished by strict enforcement of the hygiene of respiration by a rational system of lung-gymnastics. Patients must be taught to breathe and must be given the proper kind of air for this purpose. This is the philosophy of chest-gymnastics in a nutshell.

A consumptive must sleep, eat, play, live in the open air. He must under no circumstances be confined where the supply of fresh air is limited. This is rational therapy for the individual and effective prophylaxis for those whose health he imperils by contact. It is admitted on all sides that the prevention of infection is even a greater problem than the treatment of the individual patient.

Light, air and water are the victorious phalanx that never loses a battle against pathogenic organisms. They are, as L. F. Flick, of Philadelphia, Pa., correctly remarks, the natural enemies of the tubercle bacillus. Sunlight and air kill it, the water dissolves it out of its *cache*, so that light and air may get at it. The bacillus comes out of a host wrapped up in broken-down tissue which serves as a *cache*. When this broken-down tissue is deposited in a house, it dries and hardens, and the bacilli inside remain alive for a long time. When it is deposited in the open, it is dissolved or disintegrated and soon becomes devitalized. This is why an enclosure of some kind plays such an important rôle in the propagation of tuberculosis. In an enclosure sunlight, air and water can not get at the tuberculous matter and it remains vital; out-of-doors sunlight, air and water get at it, and it soon becomes sterile. Houses of one kind and another are the ordinary means of spreading tuberculosis. The home is the most frequent means and the workshop the next. This is so because it takes prolonged, intimate con-

tact with a person, place, or thing that has been intensely contaminated with tuberculous matter to give rise to an implantation. The home and the workshop are the two places where environment of sufficient intensity of contamination, and contact of long enough duration for implantation, most readily can exist. Probably three-fourths of all cases of tuberculosis which are conveyed from person to person are contracted in the home, and the other fourth is contracted in the workshop.

With the importance of air as a prophylactic agent firmly fixed in our minds we are prepared to understand the meaning of inhalation as a therapeutic measure. To exhort patients to breathe deeply while walking in the open air is excellent advice, but not of much practical value, because patients tire of monotonous and irksome exertion of this kind. We must, therefore, resort to some other means of enforcing deep inhalation. Therein lies the principal therapeutic value of all inhalation-methods irrespective of the agent used (oxygen, ozone, medicated vapors, etc.). The value lies in the act of inhalation, not so much in the character of the substance inhaled, unless it is the normal physiological lung-food, namely atmospheric oxygen.

The inhalation of manufactured oxygen out of an oxygen-tank is being advocated by some. Theoretically speaking, the inhalation of oxygen ought to be the ideal treatment of tuberculosis. It ought to, as it were, supply the missing link in the chain of vital elements which are antagonistic to the bacillus and its development. More especially ought this to be the case when the expanding capacity of the lungs is being increased by breathing exercises or by thoracic gymnastics. Clinical experience does not confirm this optimism of the theoretical physiologist. The absorption of oxygen is regulated by the physiological oxygen-carrying capacity of the blood. This again is in direct proportion to the relative number and quality of the red corpuscles. It is plain, therefore, that the forced introduction of oxygen into the air-passages does not necessarily produce

an equivalent oxygenation of the blood. In order to arrive at distinctly physiological, *i. e.* curative, effects from this method, oxygen must be not only inhaled but absorbed. The blood of a consumptive is wretchedly poor in oxygen, because the elements which carry it are poor in quality and reduced in number. Hence it is clear that the benefits of oxygen-inhalation are to a large extent illusory in character. Then again, there is present in the organism that indefinable element which demands bulk or mass of physiological fuel rather than concentration or extraction. The experiments which have been made with concentrated food-elements as a pure unmixed substitute for food in bulk or mass, apply analogously to the problem of oxygen-feeding. The disappointments which have followed these experiments have demonstrated that the human body and the test-tube of the physiologist are alike only in a provisional sense. The lungs demand bulk, not an extracted element. They crave for air, not for oxygen. Yet oxygen-inhalation is not altogether valueless. Aside from being a potent psychic factor it gives the chest a gymnastic training and helps the patient to breathe deeply.

What has been said concerning oxygen-inhalation holds good in regard to ozone-inhalation. Ozone is an irritating gas and, for this reason, is not very well borne by the air-passages of the average consumptive. The popularity of the static machine has brought ozone prominently before the professional mind. Every static machine has its ozone-generating attachment, and the enthusiastic owner of such a machine never wearies of extolling the virtues of ozone. That the enthusiasm of these men has given rise to many an extravagant claim in its behalf, it is quite natural to suppose. The odor of the gas, not unlike chlorine gas, is disagreeable to many persons. Unless the gas is largely diluted with air, it is very irritating and can hardly be borne by the average consumptive. If it is administered in a badly ventilated room, the procedure is of questionable value. Ozone is in no way superior to oxygen as an inhalant, and

possesses many disagreeable features which oxygen does not. After all, it is the mechanical act of deep respiration wherein lies the good of any inhalation method. The mechanical act of deep breathing does the good. The substance inhaled (and there are thousands recommended) is the psychic and persuasive factor. A record of chest-expansion should be kept.

Deep breathing must be enforced cost what it may. Niemeyer had an ingenious system of making his consumptive patients breathe deeply. He divided them into classes. Each class was compelled to go out into the open air and walk slowly until they were tired. Then the members of the class were given a chance to lie down in invalid chairs or hammocks and rest. One of the number had to read aloud until another one took his place. Occasionally the whole class had to read, sing, whistle or play on wind- or brass-instruments. In this way the lungs were constantly active. The children were allowed to romp over the grounds at pleasure. Those that were too weak were allowed to sit in the open air and make soap-bubbles with straws. No patient's lungs were allowed to remain idle. It makes no difference how inhalation is effected. The principal thing is to enforce it. There is a sanatorium in the Black Forest, in Germany, which—with due apology to the author of "The Divine Comedy"—has a sign over the entrance to the grounds which reads thus: "Walk slowly and breathe deeply, whoever enter here!"—Sudden changes in the temperature of the inhaled air should be avoided, especially if the bronchial symptoms are well marked.

DIET.—The criterion of dietetic directions is the tolerance of the individual stomach together with the state of individual digestion. Food should be largely tissue-building but non-stimulating. The best nitrogenous foods for the average consumptive with a fairly good stomach are lean beef, lamb, chicken, milk, eggs, peas, beans, lentils, spinach. The liberal use of whisky, by many thought to be indispensable in these cases, should be reserved until the last

stages of the disease. As a beverage, mild stimulant and tonic, beer is preferable in most cases. Too much care can not be exercised in preserving the stomach and avoiding irritating articles of food. The stomach is the mainstay of the patient. If necessary, the bowels should be kept open by tepid enemata. The diarrhea of consumptives is best controlled by irrigating the colon with warm water. In cases that do not show much febrile reaction a non-irritating mixed diet is permissible. Extremes of temperature in foods and all articles that are not strictly foods should be avoided as much as possible (spices, condiments, etc.). A consumptive should sleep or rest for a half hour to an hour after a meal. If patients can readily digest cold milk, the latter is a good substitute for cold water. In many cases the appetite can be stimulated by massage and hot applications to the stomach. The weight of the patient should be watched. Individualization is the key-note of success.

PHOTO-THERAPY.—Next to fresh air, sunlight is the most vital therapeutic element. When we call to mind the part which the actinic rays of sunlight play in the economy of nature, no further argument is necessary to prove that the treatment of tuberculosis pulmonum without actinic light is unconditionally a hopeless task. To begin with, light regulates the output and consumption of oxygen. It is, therefore, the necessary and all-powerful regulator of oxidation, the fundamental basis of all organic life. In addition to this, it is the great and universal disinfectant by whose presence and quantitative influence the degree of resisting power is determined by which animal and vegetable bodies maintain their integrity in the universal struggle for existence. Germ-life, which requires but little oxygen and is devitalized by atmospheric oxygen, is suspended by actinic light—(1) on account of the directly germicidal power of the chemical rays; (2) on account of the affinity of oxygen and light. For this reason the continued exposure to actinic light comes second in point of importance to inhalation of pure oxygen-laden air. The whole body of the patient

should be exposed so that the whole body-surface may receive the benefits of regeneration and oxidation. Light counteracts the effects of auto-intoxication by encouraging the escape of toxines, mainly CO_2 , through the skin, both in the form of gas and vapor, not to speak of the active excretion which is coincident with diaphoresis.

The use of the concentrated chemical rays of one or more arc-lights is a valuable therapeutic agent. In cases of apical infection concentration of the light on the chest-wall directly in front of the seat of infection has been practiced with some degree of success. That the germ is thus killed in its haunts by the direct action of light, is questionable. That the intense effect on the oxidation and general activity of a region so near the nidus of bacterial vegetation is bound to increase the resisting power of the infected parts, is more than likely. While all these photo-therapeutic applications are interesting and not without great therapeutic effect, it must not be forgotten that sunlight over the whole body-surface is the ideal light-treatment. During the summer-months it should be given in the open air. When the weather is cold, the solarium should be resorted to.

RADIO-THERAPY.—The X-rays promise to be of great diagnostic value. Whether their therapeutic effect in cases of tuberculosis pulmonum is worth considering, is doubtful. The researches of Pott have shown that the tubercle-bacillus resists the action of the X-rays. Even if such were not the case, it must be remembered that the rays from a soft tube do not penetrate, while those from a hard tube lack therapeutic quality. In addition to this the danger of destruction of relatively sound tissue is not inconsiderable in view of the length and frequency of the exposures which would be required, and the low vitality of the tissues of a consumptive. This seems to be the status of the question at present. For the relief of pain (pleurodynia and pleuritic stitch) the X-rays seem to render good service.

ELECTRO-THERAPY.—Galvanism, faradism and static electricity have a field of usefulness in the treatment of

tuberculosis. Within the range of their physiological action they are capable of relieving certain symptoms. Cataphoresis has received but scant recognition at the hands of electrotherapists although its usefulness in suitable cases seems to be beyond question. Mild positive electrolysis in thin persons (one electrode in front, another posteriorly, both charged positively,—the negative electrode at some distant point) seems to promise much in view of the affinity of the positive pole for oxygen. The force-modality which promises to become a very important feature of treatment in the future, is the high-frequency current. The reader will remember the remarkable effects which currents of high-frequency are capable of producing on the most vital functions of the whole organism. The ideal mode of application is the use of D'Arsonval's cage or the diasolenic body-cylinder. The systemic effects are so marked, even after three or four treatments, that the virtue of this method can not possibly be questioned. To intensify the effects of the general treatment and to concentrate the action of the current on the seat of the disease, Oudin's double resonator is the proper instrument to use, the patient being comfortably seated between the discharging discs of the instrument, one anteriorly and the other posteriorly. The salutary effects of these applications have been verified by many observers, who kept a record of the sputum-examinations and of the patient's weight.

TREATMENT AS A SOCIAL AND ECONOMIC PROPOSITION.—The rational solution of the tuberculosis problem consists in the cure of the infected person and in the protection of those who are not infected. At this advanced day, with all our knowledge of the biology of the disease, the home-treatment of this disease is out of the question. Consumptives must be given a superlative degree of air and light at all times. At the same time they must be removed from places where they can endanger the health of others. This logically places the tuberculosis-problem in the hands of the health-authorities, municipal or, better still, state or, best of all, national. In each county there should be one or more sufficiently large

tracts of land to accommodate tents and cottages for consumptive patients, who must live here among healthful primitive surroundings and under the care of a competent medical officer. A centrally located administration-building, equipped with all modern resources of hygiene and therapy, should be at his disposal. He should be an accomplished physio-therapist and bacteriologist. He should not be hampered by lack of funds or assistance, but be given ample sway to carry out modern principles of hygiene and therapy. He should have the authority of the law to back him up in his work and the co-operation of a medical state-board to control the work. Housing a consumptive should be on a par with housing a small-pox patient. The old stereotyped advice of doctors who tell their patients to go to California, Colorado, Mexico or the Carolinas, involves hardships, financial and otherwise, that are hardly in proportion to the good which most of these patients derive. Many a poor sufferer might have remained near his home and received the benefits of rational treatment along the lines indicated. The climatic and atmospheric advantages of the States named hardly compensate for the inconveniences, the discomfort, the homesickness and the lack of competent professional attention which are in store for all but the wealthy. Cincinnati is the first municipality in the United States where a municipal hospital for consumptives is being conducted with as much success as the insufficient resources will allow. Patients are housed up in several buildings, but have the advantage of air, light and natural surroundings. By conducting a vigorous educational campaign throughout the country, the people might be taught the necessity of system and united effort in the treatment of consumptives and the protection of the non-infected. The National Government, through a department of public health, must eventually take hold of this problem. This is the only way in which the nation as a whole can be protected and preserved. Additional information concerning the clinical features of tuberculosis will be found under the head of

FUNCTIONAL DISORDERS, REFLEX DISORDERS, AUTO-INTOXICATION, and in the chapter on the THERAPY OF LIGHT. Symptomatic therapy is suggested under the head of COUGH, NIGHT-SWEATS, HEMORRHAGE, DIARRHEA, etc., etc.

Typhoid Fever is the disease in the treatment of which the earliest laurels were won by strictly physiological therapy. There is not an intelligent practitioner to-day who does not practice physiological methods persistently, at least in the treatment of this one disease. Typhoid fever was at one time one of the most murderous infections, the mortality being as high as one death in two or three cases. To-day the mortality is not more than one in twenty cases. This is an achievement of hygiene, diet and hydro-therapy. In conjunction with this statement it is but fair to correct the historical error which gives Dr. Brand, a military surgeon of Stettin, credit for originating a method which he really adopted from Vincenz Priessnitz who taught and practiced the hygienic, dietetic and hydriatic method in the treatment of typhoid fever forty years before Brand published his statistics.

In order to understand the rationale of the modern treatment of typhoid fever, it is above all things necessary to be familiar with the physiological effects of cold water and the relation of these effects to the fever-process. The statement that the febrile condition in and of itself is an element of danger, is not unequivocally true. Fever, as we at this advanced day are ready to admit, is essentially salutary because it is the process of intensified combustion and metabolism by which nature effects the expulsion of morbid elements and restoration of normal conditions. Those who fear fever, commit the fundamental error of confounding fever and high temperature. The latter is usually the outward manifestation of the former. The intensity of the one, however, is not necessarily in proportion to the other. Ordinarily the body burns up at a temperature of 99° F. If the oxidation of the body is accelerated and intensified, the heat of combustion is greater and the temperature corre-

spondingly higher. In this sense fever and high temperature are correlative to each other. If the organism has been infected with toxic material, direct irritation of the heat-controlling centers may result in great variations in the body-temperature. In a case of this kind the temperature would be in no way dependent upon the fever-process. We must remember two facts, *i. e.* (1) fever *per se* is not a *destructive*, but a *constructive* element; and (2) fever and temperature are in no sense of the word synonymous.

In applying cold water to the body-surface, the reduction of the temperature is only a secondary consideration, physiologically speaking. Cold applications are made to bring about a cutaneous anemia. The sudden and forcible contraction of the blood-vessels of the skin is followed by a reaction consisting in the so-called secondary hyperemia. (See chapter on HYDRO-THERAPY.) The vessels dilate and in this way warmth and increased function of the skin are produced by a primary cold application. Increased skin-function is coincident with more active excretion of morbid material and more intense radiation of heat-units. Thus the temperature is reduced by a lessening of the amount of fever-producing toxins and by elimination of heat. Hence it is absurd to leave a patient in a cold bath until the temperature drops. This plan is based on an amateurish conception of the action of cold water in typhoid fever. Cyanosis, collapse and even death have followed this misinterpretation of hydro-therapeutic principles. The best illustration of the principle involved is furnished by the antipyretic effect of the warm and even the hot bath. In cases where the system is much depressed and cutaneous reaction is uncertain, the warm bath is a safer water-application. The cutaneous vessels are directly affected and the activity of the skin is at once stimulated. Excretion (by gas, vapor or sweat) begins and the temperature drops. The continued application of cold to the skin can not be too emphatically condemned. Suddenly induced anemia of the skin must always and promptly be followed by increase in the cutaneous circu-

lation and stimulation of skin-function. Any hydro-therapeutic measure that fails in this, is wrong in principle and incorrect in practice. This holds good, not only in typhoid fever, but in all conditions characterized by high temperature. Let us remember that sweat is concentrated heat.

A continued fever like typhoid fever should be watched with the aid of the thermometer. If the temperature is not more than 102° F. one or more cold sponge-baths daily are sufficient. If the temperature exceeds 102° F., the application of a general cold moist pack for forty-five minutes to an hour is indicated. One of these Priessnitz packs every day is sufficient if the temperature is not higher than 102° F. If the temperature rises within three hours after the pack, another application should be made or the patient subjected to immersion in a tub (Brand's method). In cases characterized by continued high fever it is excellent practice to give three packs daily and an immersion (tubbing) in the interval, unless the patient shows signs of great weakness, when the cold sponge-bath (either by direct application of a towel or sponge or by rubbing the patient through a cold moist sheet in which he is enveloped) should be substituted. Tubbing can be done, especially in children, by wrapping the patient in a dry sheet, grasping the latter below the feet and above the head of the patient, and gradually lowering patient, sheet and all, into the water. Undue excitement and exhaustion are contra-indications. If cutaneous reaction is sluggish or imperfect, warm and even hot water should be used. Sometimes alternation of heat and cold is indicated. In this way the antipyretic effect can be combined with powerful stimulation. At all times it is of vital importance to be able to individualize. Brisk rubbing of the skin during and after a cold bath is an effective way of promoting reaction and preventing collapse. In cases characterized by headache and severe brain-symptoms the cold moist pack gives considerable symptomatic relief, delirium, stupor, subsultus, etc., being lessened.

Persistent headache may call for cold applications to the

head and hot applications to the feet. In cases which are treated with the general cold moist pack this is hardly ever necessary. Abdominal symptoms (tympanites) may require a local cold moist pack to the abdomen. Diarrhea is usually controlled by starch-water or rice-water injections. Constipation is best treated by means of rectal irrigation. Bed-sores should be prevented by cold ablutions and the use of air-pillows.

The sick-room should have a wealth of air and light. The temperature in the room should be 65° F. or a trifle higher. Mental rest is imperative. The bed should be kept scrupulously clean. Feather-beds are an unhygienic nuisance. The ejecta should not be allowed to remain in the room. The food is to be regulated according to the directions which are given under the head of DIET IN ACUTE FEVERS. From the end of the second week the diet is of great significance. Food should be small in quantity but liberal in quality. Stimulants like coffee or alcohol are indicated in cases of great weakness. Patient should not take solid food until the temperature has been normal for at least two weeks.

Peritonitis is a serious complication, but not necessarily fatal. It should be treated by "derivating" packs applied to the abdomen and to the lower extremities. Perforation is fatal unless the opening is closed by agglutination or by surgical means. Owing to the almost invariably fatal character of perforation, abdominal section under these circumstances offers the only prospect, and is, therefore, justifiable.

Symptoms and complications must be met *pro re nata*. The principal feature in the management of a typhoid-fever case is the hydro-therapeutic treatment of the febrile condition. All else pales into insignificance. Proper hygienic and dietetic regulations are taken for granted. The nurse in charge of the case is the one overtowering figure in whose hand the weal and woe of the patient are placed. Without intelligent co-operation and a strong will on the part of the nurse, the most modern treatment planned by the best phy-

sician will avail nothing. For this reason the modern hospital is by all odds the best place for typhoid cases. (For further information concerning symptomatic features and complications of typhoid fever see HEMORRHAGE and other special subjects.)

Ulcer (Chronic).—To overcome the indolence of a broken surface and encourage the formation of healthy granulations, the surface should be exposed to the actinic rays (sunlight or Finsen-apparatus) as often and as long as practicable. Once every day, or every other day, the ulcer should be exposed to the Minin light (heat-rays to increase arterial blood-supply and local metabolism). If this regime is persistently carried out, healing will promptly take place. Exuberant granulations can be removed by simple positive electrolysis or by metallic electrolysis (copper, zinc or mercury-amalgam, positive electrode to ulcer) or by a sun-glass. A negative static spray is useful. High-frequency applications produce most happy results in many cases. The greater the spark-gap between ulcerated surface and electrode, the more intense the local reaction. X-rays are frequently effective (soft tube every other day for five to ten minutes at short range). Prolonged immersion in hot water is of value if the ulcer is on the arm or leg. Immersion of the whole limb is proper. These directions hold good in all forms of chronic ulceration. In many cases attention to the general condition of the patient is essential. Locally the rules of surgical cleanliness should be enforced.

United States (Climate, etc.).—Change in the surroundings of a patient is often a therapeutic measure of great significance. In order to adapt the new surroundings to the needs of the individual patient's condition, knowledge of the climatic and other peculiarities of different sections of the country is essential. The following practical classification is quoted from Cohen's "System of Physiologic Therapeutics" (Blakiston, Philadelphia) where more detailed information will be found. The list includes Canada, the United States, Mexico and neighboring islands.

MARINE CLIMATES.

Warm sedative: Bermuda, the Bahamas, the West Indies.

Moderately cool: The channel islands of California.

Cool stimulant: Long Island, Nantucket, Martha's Vineyard, Cape Cod, the Isles of Shoals.

Cold stimulant: Newfoundland, Cape Breton, Nova Scotia, Campobello, Mount Desert.

COAST CLIMATES.

Warm sedative: The shores of South Carolina, Georgia, Florida, Gulf of Mexico, San Diego, Coronado.

Cool stimulant: New Jersey coast, Lakewood, Long Island Sound, Narragansett Bay, western end of Cape Cod, north shore of Massachusetts, coast of New Hampshire and Maine, San Francisco.

Cool sedative: Portland, Ore.; Tacoma, Seattle, Olympia.

INLAND CLIMATES (low elevation, 0-1500 feet).

Warm and moist: Louisiana, eastern and central Texas, Mississippi, eastern Arkansas.

Warm and dry: Aiken, S. C.; Thomasville, Ga.; Phoenix and Salt River Valley, Yuma, Ariz.; Redlands, Riverside, San Bernardino, Pasadena, San Gabriel, Ojai Valley, Cal.; lake districts of the interior of Florida during the winter.

Moderately warm and dry: Pine region of New Jersey in the summer months.

Desert climate: Mojave desert.

Cool and moist: St. Lawrence Valley, northern California and western Oregon and Washington (not on the coast).

Cold and moist: Winnipeg, Port Arthur, Sault Ste. Marie, Duluth.

Cold and moderately dry: Southern Minnesota, North and South Dakota, Muskoka Lake region in Ontario, southern counties of New York and adjoining counties in Pennsylvania, pine region in Wisconsin and central Michigan,

northwestern Connecticut, Berkshire district in Massachusetts.

INLAND CLIMATES (moderate elevation, 1500-4000 feet).

Warm and dry: Mesilla and Lower Pecos Valley, Las Cruces, southern New Mexico, Guadalajara, Monterey, southern Arizona, southeastern California near the Sierra and coast ranges.

Moderately warm and dry: Asheville, N. C.

Cool and dry: Eastern Oregon and Washington, valleys of Idaho and Montana, southern Wyoming, El Paso, Texas.

Cool and Moist: Adirondack Mountains, White Mountains, Mount Kineo, Me.; Eaglesmere, Pocono, Pa.; Deer Park, Md.; western Virginia and North Carolina.

INLAND CLIMATES (high elevation, over 4000 feet).

Warm and dry: Northern New Mexico, central Mexico, southern Colorado, northern Arizona.

Cool and dry: Denver, Colorado Springs, Manitou and mining regions of Colorado, Montana and Idaho, Yellowstone Park, Lake Tahoe, Nev., Glacier, Field, Banff, Calgary, Rossland, B. C.

Cool and moderately moist: Roan Mountain, N. C.; Mountain Lake, Va.

Uranium is found in metallic ores containing pitchblende (uraninite), the latter being a compound oxide containing $81\frac{1}{2}$ per cent of uranium, 4 p. c. of lead and $\frac{1}{2}$ p. c. of iron with oxygen and water, and sometimes magnesia, manganese or silica. Pitchblende is found in Bohemia, Saxony, Cornwall (England) and in Colorado. Prof. Henri Becquerel, of Paris, discovered in 1896 remarkable radiations emanating from uranium and, through his discovery, established the phenomenon of "radio-activity" as a scientific fact. The radiations from uranium are known as "Becquerel rays."

In investigating Becquerel radiations from uranium Prof. Pierre Curie and his talented wife, Mme. Sklodowska Curie, in 1898 extracted a substance from uranium which had four times the radio-active power of metallic uranium.

The new substance was called **POLONIUM** in honor of Mme. Curie's native land, Poland.

In the same year the Curies found another radio-active substance in pitchblende and called it **RADIUM**. It requires 5,000 tons of uranium-residues to produce approximately two pounds of radium. What therapeutic significance is to be attached to radium future developments will show. It has been used in cases of superficial tuberculosis with apparently good results. In superficial cancer radium has been of service in a few authenticated cases. The author has verified the analgesic effects of radium in several cases of malignant disease. Caspari's experiments have shown that radium possesses marked germicidal properties. It suspends the vitality of the *micrococcus prodigiosus* in about three hours.

In 1899 Debierne extracted another radio-active substance from uranium and called it **ACTINIUM**. Its rays are deviable. Another radio-active substance extracted from uranium is **THORIUM**. In point of radio-active power it ranks next to radium.

The radio-activity of uranium is the unit of measurement. Radium, if it has a radio-activity of 7,000, possesses 7,000 times the radio-active power of uranium.—Reference to this important subject is made in the chapter on **FORCE AND FORCE-MODALITIES**. For detailed information on radium and other radio-active substances the reader is referred to an excellent monograph on the subject, written by Wm. J. Hammer, of New York.

Uremia.—The therapy consists in active elimination (hot bath, dry heat, hot packs, colon-irrigation, catheterization, cupping or leeches over the loins, venesection). For additional information see **BRIGHT'S DISEASE (CHRONIC)**.

Uterine Inertia.—Faradism up to the point of tolerance, one pole in utero, the other on the abdomen or over lumbar region. A bi-polar vaginal electrode is useful. Massage of fundus. Also applicable to post-partum hemorrhage.

Vaginismus.—In addition to forcible dilatation the use of a mild faradic current (very rapid interruptions) is indicated as a muscular tonic. If local nutrition is poor, a mild galvanic current is preferable (current reversed frequently). These applications are made by means of a vaginal electrode, one pole on the abdomen. A bi-polar vaginal electrode is sometimes useful. Applications every day or two for ten minutes or more. Intra-vaginal vibration is effective in some cases in which the spasm is of local origin (derangement of local sensory nerves). A soft-rubber attachment of suitable thickness should be employed. Local hot vapor-baths followed by cold douches have an excellent effect.

Valvular Diseases of the Heart.—The condition of one or more of the heart-valves may be one of insufficiency giving rise to a regurgitation (backward flow) of the blood. Thus there may be mitral, aortic, tricuspid or pulmonic insufficiency and resulting regurgitation. The valve-openings may be narrowed by cicatricial formations, deposits or vegetations producing a condition of stenosis causing a partial obstruction to the blood-current. Thus there may be mitral, aortic, tricuspid or pulmonic stenosis and resulting obstruction. Familiarity with the anatomy of the heart and the physiology of the circulation is necessary in order to understand the peculiar changes in the heart itself and the secondary effects on the circulatory system which follow insufficiency or stenosis of one of the heart-valves. These changes are subsequent to the crowding back of the blood-mass, and as a result the increase of blood-pressure in a retrograde direction and the alterations in the whole circulatory system.

Nature tries in conditions of this kind to stay the inevitable result by fortifying the weakening heart-muscle. In this way the disturbed relation of arterial and venous pressure is temporarily restored. The heart-muscle increases in size to meet the demand for more pumping power. The changes in the structure of the heart are the so-called com-

pensatory hypertrophies. They represent Nature's attempt to prolong the life of the patient.

The therapeutic indications in all cases of valvular disease of the heart are necessarily similar because the effects of all valvular regurgitations or obstructions are practically identical. In the case of a regurgitation, we are dealing with a decrease in the pumping power of the central circulatory organ. In the case of an obstruction, the pumping power *per se* is unimpaired, but the caliber of a main-pipe is reduced. In either case the proportion between the quantity of blood in the pulmonary circulation and in the general circulation is disturbed. Stagnation is the result with uneven distribution of the blood-mass in the different parts of the circulatory system. The lungs are overfilled, the flow of the blood in the large veins of the general circulation becomes more and more sluggish, more blood is crowded back, while the blood coming from the lungs or entering the aorta becomes less and the arterial pressure in the system at large is gradually reduced. The pulmonic hyperemia causes dilatation of the pulmonic vessels, especially of the capillaries surrounding the alveolar spaces. Eventually the delicate capillaries can not resist the pressure of the constantly increasing blood-mass. Rupture of capillary vessels, a hypostatic congestion and catarrhal conditions are the result. The chronic hyperemia causes hyperplastic and hypertrophic changes in the tissues. The lung-parenchyma increases in size, connective tissue proliferates and a cirrhotic or fibroid condition of the lungs is the result.

The stagnating blood-mass increases the pressure in the venous circulation of the liver, the spleen, the pancreas, the kidneys, in fact all the organs of the body. Chronic passive hyperemias in these organs, especially in the kidneys and impairment of the secretory and especially the excretory function of these organs are the result. The lowered heart's action and the pressure of the sluggish venous circulation produce capillary stagnation throughout the system. Owing

to the defective excretion there is a retention of liquids in the body, causing distinct liquefaction of the blood. The aqueous elements of the blood pass through the vessel-walls in large quantities and enter the connective tissue causing edematous swellings.

The natural history of valvular heart-disease as outlined above contains the therapeutic indications. The objects of the treatment should be to diminish the quantity of fluids in the body (depletion of the pulmonary and the general venous circulation, unloading the heart and the kidneys) and in this way to re-establish as far as possible the proportion between arterial and venous pressure and thus counteract the pathologic changes in the different structures and organs of the body.

These effects represent the physiological purposes of rational therapy in the treatment of organic diseases of the heart. In this respect the physio-therapeutic methods occupy a commanding position because they are directly adapted to the working out of these mechanical problems.

The physiological effects of diminution of the liquids of the body concern primarily the vascular system. The lessened amount of the blood which circulates in and through them causes the vessels to accommodate themselves to the diminished blood-mass and blood-pressure. As a result the vessels contract unless the walls of the vessels have by long-continued intra-vascular pressure lost their tone. This is the case in the last stages of circulatory disease. After forced abstraction of fluid from the body, the physiological equilibrium can be maintained by regulating the amount of the fluids which enter the body (drink). The secondary effect of forced abstraction of fluids from the body is the absorption of the serum which has accumulated in the cavities of the body and in the connective tissue (dropsy).

Systemic exercise is of superlative value as an agent for the reduction of liquids in cases of organic heart-disease. The Swedish method consists in thorough massage and passive movements of all parts of the body administered every

day or two. This plan is applicable in weak patients or during inclement weather. It must be carried out in a thorough and systematic manner to be of any avail. Slight improvement usually follows after two or three weeks of treatment. The Nauheim plan was evolved from the Swedish method. It consists in massage and in the systematic application of mild concentric and excentric Swedish movements. The patient's strength must not be taxed. Resistance must be slight and never carried to the point of fatigue, dyspnea or palpitation. Individualization means everything in these cases. The patient is treated every day, massage and movements being properly measured and alternated. In addition thereto baths in saline water and other hydrotherapeutic measures are employed to stimulate the skin and aid in the eliminative process. M. J. Oertel, whose excellent monograph on this subject should be read by every physician who attempts to treat heart-disease, advises active exercise and gives explicit directions concerning respiratory gymnastics, which are accentuated by the patient walking up hill. The patient is made to take ten or twelve steps ascending a hill and then instructed to rest in the standing posture. Inspiration is long, deep and forcible, while expiration is short and rapid. Excretion through the lungs and through the skin is increased and the exchange of gases in the lungs becomes more nearly normal. Oertel supplements therapeutic mountain-climbing with inhalation of compressed air. The object of the latter is the mechanical expansion of the lungs after the decrease of aqueous elements has begun. After four to six weeks of respiratory gymnastics as outlined above, inhalations of compressed air four or six times daily, thirty minutes each time are given, beginning with 1-100 atmosphere and gradually increasing the pressure. The treatment must be continued for months and years.

The degree of blood-pressure in the veins depends largely upon the position of the body as a whole, the position of the several parts of the body and the relative state of contraction and relaxation of the muscles. Pressure is less-

ened by putting the body in the horizontal position. It would appear, therefore, that the best effects can be produced by putting the patient on his back and administering deep centripetal effleurage. Passive movements of the extremities should be added to enhance the depleting effect. This is a good mechano-therapeutic measure for advanced cases and where the application of Oertel's method is not practical or practicable.

Vibration can be added to accentuate the effect of massage. Vibrate centripetally along the course of the large venous trunks in the extremities. If compensation is good, vibration over the precordial space improves the quality and retards the rate of the heart-beats. Central stimulation along the upper dorsal vertebræ is useful in many instances. Vibratory treatments should not be too long continued.

Hydro-therapy and thermo-therapy are powerful agents in the treatment of organic heart-diseases. In careless or reckless hands they are dangerous agents. If properly used, their value can hardly be overestimated. They help in the slow dehydration of the system which should be the first aim in the therapy of heart-lesions. The large thermic cylinder is, in my estimation, a most valuable adjunct. Its use should be mild and be adapted to the features of the individual case. It should be used as a gentle diaphoretic agent once or twice a week. The temperature need not exceed 200° F. The patient should perspire without much heat or depression. General massage should always be administered after a sweat-bath of this kind. Instead of the thermic cylinder, the general electric-light bath, the warm vapor-bath, the warm sitz-bath or hot sparks to the lower portions of the body, might be made use of. Cold applications are contra-indicated in heart-cases on account of the sudden congestion of the deep vessels coincident with the primary cutaneous anemia which is produced by cold packs, etc. (See chapter on THE USES OF HEAT AND COLD.) The heart might not be equal to the suddenly imposed tasks of increased function. The benefits from gaseous baths as given at Nauheim are largely suggestive.

All the therapeutic agents named, especially active movements and dry heat, are contra-indicated in cases of imperfect compensation, of dilatation, atheromatous degeneration of the vessel-walls, arterio-sclerosis of the heart and blood-vessels. They are only applicable when the vessels are in fairly good condition and the heart is protected by a compensatory hypertrophy. Inflammatory conditions of the heart are a contra-indication to precordial vibration.

The patient must be enjoined to avoid anything and everything that might tax the working power of his heart, *e. g.* excitement, fright, exertions, sexual indulgence, etc. All the energy of the patient, especially in the advanced stages, should be therapeutically utilized.

Regulation of the patient's diet is very essential. The quantity of liquids must be reduced as much as the patient will stand. This is in keeping with the idea of dehydration of the system, which Oertel considers the alpha and omega of therapy in these cases. Alcohol and tobacco should be avoided. Meat can be allowed in moderate quantities if the stomach will stand it. In the first stage of valvular disease of the heart a consistent vegetable diet is physiologically indicated to aid in the process of oxidation and prevent waste-accumulation. In the advanced stages the administration of tissue-building foods is necessary. (See FATTY DEGENERATION OF THE HEART.) The colon should be irrigated every second or third day with the patient lying down on the left side.

The general management of a case should include all the hygienic necessities that people ordinarily are apt to ignore. Sun-baths help to dehydrate the system. Pleasant surroundings and agreeable mental impressions preserve the vitality of the nervous system. It must be remembered that valvular heart-disease *per se* is incurable. The object of the therapeutic directions given is to establish a *modus vivendi* that will enable the patient to live as long and as comfortably as is possible under the circumstances. The patient is on the down-grade. If he follows the plan outlined

he will postpone the inevitable and render his life more agreeable to himself and more useful to his surroundings than he could if he fails to adapt his mode of living to the requirements of his condition. The habitual use of so-called heart-tonics, heart-stimulants, etc., can not be too emphatically condemned. (Oertel.) Their use is analogous to the whip by which a wind-broken horse is made to run until exhaustion of the vital forces causes it to collapse. Digitalis, spartein, strophanthus, glonoin, etc., undoubtedly produce a display of increased energy on the part of the heart, which fact makes them available as ready means of bridging a patient over a momentary weakness. Their use is in such a case the lesser of two evils. To employ them in the regular treatment of these ailments is purely symptomatic treatment and physiologically not justifiable. The treatment of circulatory disturbances must be centrifugal. Regulate the circulation in the vascular system and you will regulate the heart. The drug-dispensing empiric proceeds *vice versa*, *i. e.* in a centripetal direction. He whips up the heart in order to adjust irregularities of the vascular system. He whips up the kidneys by diuretics in order to prevent waste-retention, which is the physiological sequence of the disproportion in the arterial and venous pressure in the kidneys. It may be more convenient to proceed in this manner, but it certainly is not on the level of physiological knowledge which the researches of Leyden, Péttenkofer, Schott, Funke, Seguin, Landois and others have given us on the subject of the physiology of the circulatory apparatus.

A number of electrical modalities can be advantageously employed in valvular disease of the heart. Systemically the high-frequency current is of the greatest benefit (D'Arsonvalization). It can be applied locally by means of a vacuum-tube to the dorsal section of the cord and to the sides of the neck (vagus). Galvanization or faradization is useful in impending heart-failure. The positive sponge-electrode is placed below the ear, the negative over the heart and moved about. The current should be mild, and, if it is a faradic current, rapidly interrupted. Static electricity can be ad-

ministered by means of insulation (positive sedative, negative stimulating), negative spray to spine (stimulating), general positive spray (sedative). The electric water-bath is beneficial, but requires great caution. Exposure of the precordium to Minin rays frequently has a prompt anodyne effect.

The details of treatment depend to a large extent on the features of the individual case. The suggestive influence of the physician is a powerful factor in preparing the soil for physiological treatment. Much will depend on the functional integrity of the stomach. It should be preserved and protected at all hazards. Keep the mind of the patient off his physical condition. For this purpose a change of surroundings is often advantageous. The beneficent effects of the Nauheim treatment, with all due regard for the importance of mechano-therapy and hydro-therapy, are in no small measure attributable to the suggestive influence of the place itself, a veritable paradise on earth, about which hover the traditions of the thousands of invalids who have thither wended their weary way to find hope and health in the romantic pine-forests of the Taunus and its world-famed health resort.

Varicose Veins.—Locally, attempts should be to lessen the pressure of the venous blood (horizontal position, elastic bandage). Centripetal massage is valuable. Begin halfway between hip and knee and force the venous blood into the abdominal cavity. After five minutes' massage start at the knee, a few minutes afterwards below the knee, etc., the object being to empty the veins above in order to make room for the ascending venous blood from below. Massage must be gently and carefully executed and should be followed by a warm compress to stimulate local metabolism. Large varices should receive special massage. Instead of the pack a negative static spray can be given for ten minutes.

The general treatment should include abdominal massage, irrigation of the colon and a strictly vegetarian diet. (See AUTO-INTOXICATION.)

Varix.—Insert positive platinum-needle in the vein, negative pole near by, galvanic current, ten milliamperes for five to ten minutes. When clot has formed, reverse the current to loosen the needle. Cleanliness is essential.

Vascular Tumors.—Positive electrolysis (see first part of the book) is commonly used in the removal or rather in the destruction of angiomas, birth-marks, cirroid aneurisms, varices, nodules and dilated vessels in acne rosacea, moles, polypi, fungi, warts, verrucae, and wine-marks. One or more needles are used, depending on the depth and extent of the lesion. The object of positive electrolysis is to obliterate the small arterioles. Bennett recommends the application of a positively charged small wet cotton or sponge pad after using sodium chrom-ethylate on the surface, negative pole near by, five to ten milliamperes, five to ten minutes every week. Neiswanger advises introduction of several needles by means of a multiple needle-holder connected negatively, positive pole near by or in patient's hand, application to be continued until considerable blanching around the point of needle-puncture has taken place. This is negative electrolysis. The same author advises the use of a negative needle introduced below the epidermis parallel to the skin until blanching occurs. Several punctures of this kind can be made during the same sitting. If the vascular element predominates, positive electrolysis is preferable. In ordinary warts and other growths largely composed of cellular and fatty tissue, negative electrolysis is given preference.

X-rays have been used successfully in the treatment of wine-marks and other telangiectatic conditions. Applications are made with soft tube, five to ten minutes every other day until local reaction shows. Finsen-rays cause pigmentation in the naevoid surface, thus substituting a yellowish discoloration for the red mark. To produce this effect an arc-light of fifty amperes and more must be used. Cases of wine-marks have been successfully treated by thermic solar rays, concentrated by means of a sun-glass. In using positive or negative electrolysis, much depends on the technique

of the operator, who must be careful not to cause too much destruction and subsequent disfiguring cicatrization.

Versions of the Womb.—Principles of treatment similar to those mentioned under the head of FLEXIONS. Removal of the cause is paramount (inflammatory conditions, exudates, adhesions, etc.). Pessaries are obsolete. Massage and faradism are the most valuable agents after inflammatory symptoms have subsided.

Vomiting of Pregnancy.—Galvanization of the vagus (side of neck below ear to intra-clavicular space) or phrenic (side of neck to epigastrium) is beneficial. Positive static spray to stomach and spine. Vibration to side of neck, stomach and dorsal vertebræ is useful. (See REFLEX DISORDERS.)

X-ray Burns.—Moist warmth or heat seems to possess considerable palliative and curative virtue. If the "burn" is on the arm or leg, continuous immersion of the extremity in warm water is by far the most effective treatment.

X-ray Coil (portable).—Diagnostic X-ray work will never serve its purpose adequately until X-ray coils of sufficient power are constructed that can be moved from place to place. Many a patient can not be taken to a hospital or a radiographer's laboratory for an X-ray examination (*e. g.* injuries of the hip-joint, severe gunshot wounds, etc.). These patients can not be given the benefit of X-ray diagnosis unless the X-ray machine is brought to their bedside. The accompanying illustration shows a portable equipment, the energy being furnished by a secondary battery.

X-ray Statistics.—In the chapter on X-RAY THERAPY and elsewhere reference has been made to the manifold therapeutic uses of the mysterious rays of Roentgen. The references made were largely suggested and influenced by the author's experience. For the sake of completeness and in order to afford the reader a broader view of the subject, the author has gathered the statements of at least fifteen of the best and most reliable observers from all parts of the world and offers the following résumé as a fair estimate of the clinical uses of the Roentgen rays at the present time.

All observers agree that in the treatment of skin-cancer (epithelioma) the X-rays are at their best. The time which elapses before a healthy action is noticeable, is subject to variation. The location of the trouble, the general condition of the patient and the relative skill of the operator have



A PORTABLE X-RAY EQUIPMENT.

much to do with the comparative promptness with which the individual case yields. On general principles it may be stated that the cases of skin-cancer which are not curable by means of the X-rays are exceptional.

Cancer of the tongue, soft palate and larynx are sometimes benefited by X-ray treatment, although the cured cases are rare but sufficiently well authenticated to demonstrate the possibilities of the X-rays in the conditions referred to. Nearly all observers agree that the progress of

the diseased condition is retarded by the X-rays and thus the life of the patient prolonged.

In regard to cancer of the breast a singular diversity of opinion seems to prevail, even concerning the propriety and relative efficacy of the X-rays in the early stages of the disease. That the cure of primary breast-cancer is possible under radio-therapeutic treatment, is admitted in view of a number of cases of this kind which have been reported. Most of the observers favor surgical interference followed by X-ray treatment.

A few cases of uterine cancer that are supposed to have been cured by the X-ray, have been reported. In all these cases the seat of the malignant process was in the cervical portion and treatment was given *per vaginam*. The vagina is protected by an opaque speculum. Treatment through the abdominal wall is admittedly of doubtful value.

In rectal cancer, if the seat of the trouble is not extensive and directly accessible to the rays, good results might be looked for. The use of the Roentgen rays in cases of this kind requires considerable technical skill. In cancer of the stomach and other deep-seated structures, X-ray treatment seems to offer no encouragement.

All authors admit and emphasize the wonderful power of the Roentgen rays in relieving the pain of malignant disease, even if the lesion is deep-seated.

In the treatment of lupus vulgaris the X-rays are equal to any other agent and superior to most modes of treatment. The points in favor of X-ray treatment are: it is easily given, is painless and consumes but little time. The Fin-sen-rays are equally effective but require prolonged exposures. In the erythematous variety of lupus X-ray treatment does not seem to be of much avail.

Splendid results by the proper application of the Roentgen rays have been achieved in all the parasitic diseases of the hair-follicles and nails (*tinea tonsurans*, *sycosis*, etc.). In many papular skin-diseases the X-rays are of great value. In psoriasis splendid results are frequently achieved, even in cases that had resisted all other modes of treat-

ment. In acne the X-rays are admittedly of great value, if used properly.

The Roentgen-rays are probably the most valuable therapeutic agent in the treatment of pruritus. It is immaterial whether there is a concomitant skin-lesion or not. If there is, it is favorably influenced by the X-rays. Splendid results have been reported in all the pruriginous skin-afflictions (anal, vulvar, intertrigo, neurotic, etc.). In these respects the X-rays rival the high-frequency currents. The effects are attributable to the tonic-stimulant action of the X-rays referred to by the author (see page 297).

In a general way the summary of opinion offered does not differ from the statements made in the chapter on X-RAY THERAPY (see page 301). From a biologic point of view the preponderance of opinions seems to favor the supposition that the action of the X-rays is spent on and in the blood, more especially the erythrocytes (red cells). It is generally thought that at first the X-rays cause an increase in the absolute number of white cells in the cutaneous circulation. This effect is noticed within eight to twelve hours after the exposure. After twelve hours the number of white cells decreases, especially if a hard tube had been used. During the first twelve hours no appreciable effect is noticed on the red blood-cells. After the first twelve hours many red blood-cells appear broken up. The hemoglobin gradually diminishes in quantity. In cases where the red corpuscles are thus affected even after one exposure, a therapeutic reaction usually follows, *i. e.* devitalization of morbid tissue and a coincident tendency towards granulation. In these rapidly yielding cases pigmentation of the cuticle does not usually occur. In the negro the therapeutic effect is not infrequently associated with disintegration of skin-pigment, resulting in the appearance of permanent blanched blotches. If the action of the X-rays could in every case be with certainty foretold in connection with the relative degree of resisting power of skin-pigment, the attempts to turn negroes white could be made with a reasonable amount of success and without any damage to the system at large.

GENERAL INDEX.

- Abdominal congestions, 90, 91.
Ableitendes Verfahren, 89.
Abortion, justifiable, 430.
Abscess. See Sepsis.
Absorption, 84, 160.
Adrenalin-cataphoresis, 398.
Acne, 235, 301, 451, 503.
Acne rosacea, 214, 301.
Actinic rays, 147.
Actinium, 491.
Active movements, 115.
Acute infections. See Fever.
Affusion (Kneipp-douche), 91.
After-dinner nap, 50.
Agalactia, 405.
Albers-Schoenberg, 260.
Alcohol, 64, 65.
Alcoholism, 307.
Alopecia, 307.
Alopecia areata, 155, 307.
Alternating currents, 171.
Amenorrhœa, 308.
Amperage, 167, 199.
Anal fissure, 308.
Anemia, 235, 308.
Aneurysm, aortic, 309.
Aneurysm, cirroid, 214.
Angina, 90.
Angina pectoris, 309
Angioma, 214, 310.
Animal kingdom, 53.
Animal magnetism, 107, 141,
142, 375.
Ankle sprained, 99.
Ankylosis, 453.
Anodal axis, 252.
Anodal electrolysis, 213.
Anode, 237.
Anorexia. See Dyspepsia.
Anteflexion, 360.
Anteversion, 501.
Anthrax, 154.
Anti-cathode, 237.
Aphasia, 310.
Aphonia, 310.
Apoplexy, 90, 370.
Apostoli's method, 216, 360.
Appendicitis, 91, 310.
Arc-light, 147.
Arterio-sclerosis, 311.
Arthritis. See Stiff Joints. Bier's
Stasis. Tuberculosis of
Joints.
Arthritis deformans, 444.
Asiatic cholera, bacillus of, 154.
Asphyxia, 311.
Asthma, 311.
Atavism, 5, 394.
Atheromatous vessel-walls, 90,
96, 112, 311.
Atmospheric pressure, 226.
Atrichiasis. See Alopecia.
Atrophic paralysis, 421.
Atrophy, 130, 225.
Aufrecht's experiments, 146.
Auto-conduction cage, 206.
Auto-intoxication, 36, 90, 312.

Bacteria, 8, 32, 33, 146, 154, 298,
425, 480.
Bacteriology, 33.
Bacterium coli commune, 154.
"Baking," 96.
Baldness, 155, 307.
Barber's itch. See Sycosis.
Basedow's disease. See Ex-
ophthalmic goitre.
Beck's tubular diaphragm, 282.
Becquerel rays, 490.
Bell's palsy, 421.
Bennett, H. C., 186, 465, 500.
Betz Electric Light Bath, 318.
Bier's Stasis, 79, 312, 446, 466.
Biliary Calculi. See Calculi.
Biliousness. See Auto-intoxica-
tion. Dyspepsia. Jaundice.
Birth-marks, 214, 313.
Bladder, inflammation or ca-
tarrh, of, 337.
Blech, G. M., 393, 390.

- Bloch on high frequency, 232.
 Blood-spitting, 369.
 Blue light, 157, 164.
 Boas on massage, 110.
 Boas on diet in constipation, 330.
 Bone-setting, 101.
 Bony growths, 217.
 Bouchard, 36.
 Bowel-function, 34.
 Bowels, congested, 90.
 Brand's water-treatment, 484, 486.
 Brandt's massage, 21, 113, 422.
 Breast, cancer of, 301, 387, 503.
 Breast, function of female, 405.
 Breeze, static, 187.
 Bright's disease, 87, 99, 313.
 Bronchitis, 322.
 Bruise, 87, 158, 323.
 Bubo, 326, 461.
 Buechner, Ludwig, 26.
 Bulbar paralysis, 421.
 Buttermilk in rheumatism, 440.

 Calculi, 324.
 Caldwell's tube, 299.
 Calories, 61.
 Cancer, 301, 325, 364, 501.
 Carbuncle, 156.
 Carcinoma, 301, 502.
 Carnivora, 53.
 Catalysis, 212.
 Cataphoresis, 191, 218, 391.
 Catarrh, 382, 405.
 Catarrhal state, 382.
 Catching cold, 82.
 Cathodal electrolysis, 214.
 Cathode, 237.
 Causal symptoms, 10.
 Causes of disease, 7, 8, 26, 27, 35, 63.
 Cedergreen, 189.
 Central stimulation, 130.
 Cephalalgia, 368, 406, 410.
 Cerebral hemorrhage, 90, 370.
 Chancre, 326.
 Chancroid, 326.
 Charcot, 397, 432.
 Chemical effects of electricity, 209.
 Chemical sources of electricity, 169.
 Chemistry of foods, 59.
 Chest-massage, 471.
 Chilblains, 326.

 Chloasma, 394.
 Chorea, 326.
 Chromo-therapy, 162, 432.
 Cicatrices, 215.
 Cirsoid aneurysm, 214.
 Clap, 367.
 Clothing, 30.
 Coal-tar products, 17, 358.
 Cocaine, 218.
 Cohen, 47, 488.
 Cold, 68.
 Cold in the head, 405.
 Colic. See Enteritis. Pain.
 Colon irrigation, 327.
 Color, effects of, 162, 432.
 Colors, 41, 162.
 Comedo, 451.
 Comma bacillus, 154.
 Compressed air, 325, 326.
 Concentric movements, 115.
 Condensed air. See Compressed air.
 Condensation-couch, 204.
 Conductors, 167.
 Congestion, 79, 82, 92, 225.
 Conjunctivitis. See Inflammation.
 Conjunctivitis, ultra-violet, 231.
 Constant current. See Galvanic current.
 Constipation, 35, 125, 328.
 Contusion, 87, 158, 323.
 Convection, 187.
 Copper-electrodes, 217.
 Copper oxy-chloride. See Metallic electrolysis.
 Corns, 335.
 Corset, 27.
 Cough, 335.
 Coulomb, 167.
 Cupric electrolysis, 213.
 Curie, Pierre, and wife, 490.
 Currents, 171, 174.
 Cutis anserina, 76, 85.

 Dandruff, 338.
 D'Arsonval, 202, 230, 234, 235.
 D'Arsonvalization, 236.
 Darwin, 5, 54, 446.
 Deafness, 338.
 Debierno, 491.
 Degeneration, 5, 42, 130.
 "Derivating" method, 89.
 Derivation, 89, 338.
 Dermo-lamp, 153.

- Destructive action of current, 209.
 Developing fluid, 272.
 Diabetes insipidus, 338.
 Diabetes mellitus, 339.
 Diagnosis, 6.
 Diaphoresis, 83.
 Diarrhea, 341.
 Diasolenic cylinder, 201, 206, 235.
 Dielectric, 188.
 Dietetics, 12, 45.
 Diet for the sick, 58, 342.
 Digestive process, 48.
 Dilated capillaries, 214.
 Dilated stomach, 59.
 Diphtheria-bacillus, 148.
 Diphtheritic paralysis, 421.
 Direct current, 171.
 Disease defined, 4, 6.
 Disruption, 188.
 Disturbances of nutrition, 13.
 Donovan's solution, 387.
 Drinking water, 37.
 Drug-action, 2, 16, 17, 18, 434, 498.
 Drug-habits, 342.
 Drugs, 16, 25, 94, 343, 426.
 Dry heat, 94.
 DuBois-Raymond, 74.
 Dysentery, 344.
 Dysmenorrhea, 197, 344.
 Dyspepsia, 344.
 Eccentric movements, 115.
 Eczema, 155, 235, 301, 451.
 Effluage, 105.
 Electrical terms, 165, 173.
 Electricity defined, 166.
 Electric Light Bath, 158, 318.
 Electro-cautery, 353.
 Electro-chemical effects, 212.
 Electrodes, faradic and galvanic, 178, 179, 183, 219.
 Electrodes, high frequency, 206.
 Electrodes, static, 191.
 Electrolysis, 213.
 Electro-mechanics, 165.
 Electro-physics, 165.
 Electro-therapeutic currents, 173.
 Emphysema, 353.
 Empirical methods, 14.
 Enchondroma, 217.
 Endometritis, 354, 388.
 Endosmosis, cutaneous, 75.
 Enlarged tonsils, 356.
 Enteric fever. See Typhoid fever.
 Enteritis, 356.
 Epididymitis. See Orchitis. Inflammation.
 Epilepsy, 39, 356.
 Epithelial hypertrophies, 215.
 Epithelioma, 301, 303, 501.
 Epistaxis, 369.
 Esmarch's antiseptics, 146.
 Ether, 137.
 Ethereal molecule, 137.
 Ethics of food, 51.
 Ewald's salol experiment, 109.
 Exanthematous diseases, 358.
 Excentric (eccentric) movements, 115.
 Exercise, 101.
 Exophthalmic goitre, 366.
 Exostosis, 217.
 Explosion of coil or tube, 286, 287.
 External medication, 17.
 Exudates, 91, 390, 422.
 Eye-lids, granulated, 368.
 Facial neuralgia, 409.
 Facial paralysis, 421.
 Faraday's experiment, 172.
 Faradic current, 174, 220.
 Faradism, 174, 220.
 Faradic coil, 183.
 Fatty heart, 357.
 Favus, 302.
 Fever, 13, 73, 357, 484.
 Fibroid tumors, 216, 359.
 Fibroma, 216.
 Fifth nerve, 409.
 Finsen, Niels R., 147, 295, 400, 446, 451.
 Fistula in ano, 360.
 Flexions of the womb, 360.
 Fluoroscope, 243.
 Fluoroscopy, uses of, 244.
 Fraenkel's movement-cure, 396.
 Freckles, 361.
 Frequency, low, high, 233.
 Freund on high frequency, 234.
 Food defined, 46.
 Force, 136.
 Force-modalities, 136.
 Friction, 105.
 Frictional electricity. See Static electricity.
 Friction-machine, 185.

- Functional disorders, 361.
 Fungus, 214, 216.
 Furuncle, 155, 449.
 Galactorrhœa, 405.
 Gall-stones, 244.
 Galvanic current, 174, 209.
 Galvanic current, absorbent effects of, 210.
 Galvanic current, action of positive pole of, 213.
 Galvanic current, action of negative pole of, 214.
 Galvanic current, anodyne effects of, 210.
 Galvanic current, chemical effects of, 212.
 Galvanic current, electrolytic effects of, 213-216.
 Galvanic current, general applications of, 212.
 Galvanic current, interrupted, 210.
 Galvanic current, mild applications of, 211.
 Galvanic current, physiological effects of, 209.
 Galvanic current, sedative effects of, 210.
 Galvanism, 174, 209.
 Galvanization, 212.
 Gaston's method, 387.
 Gastralgia, 410.
 Gastric cancer, 365.
 Gastric ulcer, 365.
 Gastritis, 365.
 Geisler's experiments, 38, 146.
 General paralysis of the insane, 422.
 Germs. See Micro-organisms.
 Geyser's treatment of trachoma, 368.
 Goitre, 217, 366.
 Goitre, exophthalmic, 366.
 Gonococcus, 152, 214.
 Gonorrhœa, 214, 367, 443.
 Gonorrhœal rheumatism, 443.
 Goose-skin, 76, 85.
 Gout, 368.
 Granger, 386.
 Granulated eye-lids, 368.
 Grave's disease. See Exophthalmic goitre.
 Green light, 164.
 Ground wire, 188.
 Gymnastics of the chest, 471, 474.
 Gynecological massage, 21, 113, 422.
 Hammer, Wm. J., 491.
 Hair-follicles, diseases of, 503.
 Hair, superfluous, 214, 302.
 Hard tube, 242.
 Hay-fever, 311.
 Headache, 14, 90, 104, 212, 368.
 Health defined, 4, 225.
 Heart, fatty degeneration of, 357.
 Heart and adnexa, inflammatory conditions of, 423.
 Heart, palpitation of, 414.
 Heart, valvular diseases of, 492.
 Heat, 68.
 Heat-stroke, 86, 454.
 Helio-pantheism, 140.
 Hematemesis, 370.
 Hemoptysis, 90, 369.
 Hemorrhage, 90, 214, 369.
 Hemorrhoids, 372.
 Hepatic cancer, 372.
 Hepatic cirrhosis, 372.
 Hepatic congestion, 90. See Jaundice.
 Herbivora, 54, 56.
 Herdman, W. J., 462.
 Heredity, 5.
 Herpes, 451.
 Hexenschuss. See Lumbago.
 Hiccough, 447.
 High frequency apparatus, 199.
 High frequency currents, 176, 229, 234, 235, 504.
 Hilton's definition of pain, 406.
 Hippocrates, 26, 45.
 Homeopathy, 23.
 Hoorweg on high frequency, 234.
 Hydrocele, 373.
 Hydro-electric bath, 345.
 Hydro-faradic applications, 221.
 Hydro-galvanic applications, 219.
 Hydro-therapy, 18, 68.
 Hygiene, 12, 24, 51.
 Hygrometer, 186.
 Hypertrichosis, 214, 302, 451.
 Hypertrophy, 130, 210, 212-218.
 Hypochondriasis, 373.
 Hysteria, 87, 88, 373, 420.

- Ice-applications, 87.
 Impotency. See Sexual weakness.
 Incontinence of urine, 376.
 Indigestion. See Dyspepsia.
 Induction, 172, 200.
 Inertia, uterine, 491.
 Infantile paralysis, 421.
 Inflammation, acute, 376.
 Inflammation, chronic, 381.
 Influence-machine, 187.
 Influenza. See Fever.
 Inoperable malignant disease, 385.
 Insolation, 86, 454.
 Insomnia, 90, 388.
 Instrumental massage, 119.
 Instrumental movements, 119.
 Insulation, 167.
 Intercostal neuralgia, 410.
 Interrupted current. See Faradic current.
 Intestinal hemorrhage, 371.
 Intestines, congested, 91.
 Intra-pelvic inflammations, 388.
 Invisible rays, 147.
- Jaundice, catarrhal, 393.
 Joints, stiff, 453.
- Kassabian, M. K., 276.
 Kattenbracker's experiments, 152.
 Kellogg, 98.
 Keloid, 302, 451.
 Keratosis senilis, 302, 451.
 Kidney-function, 34.
 Kinesi- (properly *Kineseo*-) therapy, 114.
 Kjeldsen's lamp, 152.
 Kneipp, 37, 91, 92, 94, 398.
 Koumiss, 365.
 Kraftumwerthung, 41, 140.
- Laboratory-methods, 351.
 Laryngitis. See Tonsillitis.
 Lateral sclerosis, 393.
 Lead-poisoning. See Constipation. Paralysis.
 Lenstrom's experiments, 223.
 Leucorrhœa, 393.
 Leukemia, 302.
 Leyden jars, 190.
 Lichen planus, 302, 451.
 Light, 144.
- Light, biologic importance of, 145.
 Light, germicidal effects of, 146, 154.
 Light, physics of, 147.
 Line of rest, 139.
 Ling, P. H., 104, 114.
 Liver, cancer of, 372.
 Liver, cirrhosis of, 372.
 Liver, congestion of, 90.
 Liver-spots, 394.
 Locomotor ataxia, 394.
 Lombroso, 42.
 London Hospital lamp, 152.
 Lues. See Syphilis.
 Lumbago, 22, 125, 410, 436, 444.
 Lung-exercise, 474.
 Lung-fever, 425.
 Lung-function, 31.
 Lungs, congestion of, 90, 91.
 Lupus erythematosus, 235, 303, 400, 451, 503.
 Lupus vulgaris, 214, 302, 400, 452, 503.
- Maggiora on massage, 111.
 Magnetism, 165.
 Malaria, 401.
 Malignant disease, inoperable, 385.
 Marriage of consumptives, 475.
 Massage, 20, 101, 104.
 Massage of the chest, 471.
 Massage of the stomach, 349.
 Massey's method, 218, 390, 400.
 Mastitis, 405.
 Mastkur, 374.
 Mastoiditis. See Inflammation.
 McCaskey, G. W., 463.
 Meat, 52.
 Meat, relation to cancer, 388.
 Mechanical sources of electricity, 170.
 Mechano-therapy, 101.
 Melancholia, 402.
 Meningitis, 90, 403.
 Menorrhagia, 214, 371, 404.
 Mercury in lues, 460.
 Metallic electrolysis, 217, 390, 400.
 Metritis, 385, 404.
 Metrorrhagia, 214, 371, 404.
 Metschnikoff, 36, 364.
 Mezger, Prof., 104.
 Micrococcus gonorrhœicus, 154.

- Micrococcus prodigiosus, 491.
 Micro-organisms, 8, 32, 33, 146,
 154, 298, 425, 480, 491.
 Migraine, 404.
 Milk-secretion, 405.
 Milliampere-meter, 180.
 Milzbrand, 146.
 Minin, 98, 157, 327.
 Mitchell, Weir, 333, 374, 397,
 420.
 Mogigraphia. See Writer's
 cramp under Occupation-
 neuroses.
 Moles, 214, 405.
 Moleschott, 140.
 Monell, 197.
 Morton wave current, 198, 225,
 228.
 Movement-cure, 114, 396.
 Music, 42, 433.
 Myalgia. See Rheumatism, mus-
 cular.

 Nails, diseases of, 503.
 Nasal catarrh, 405.
 Nasal septum, 217.
 Nature's bedside method, 9.
 Nauheim carbonated baths, 496.
 Nauheim massage, 495.
 Negative electrolysis, 214.
 Negatives, 269, 270.
 Negroes, pigment in the skin of,
 156, 504.
 Neiswanger, 226, 373, 500.
 Nervous diseases, 406.
 Nervousness, 87, 197, 410.
 Nervous system, 127.
 Nephritis, 87, 99, 313.
 Neuralgia, 406.
 Neuralgia, facial, 211, 409.
 Neurasthenia, 197, 212, 410.
 Neurosis, case of gastric, 20.
 Newman's method, 215, 430.
 Night-sweats, 412, 470.
 Non-destructive action of cur-
 rents, 209.
 Non-reactive water-applications,
 93.
 Nordau, Max, 42.
 Nose-bleeding, 369.
 N-rays, 143.
 Nutrition, 13, 76, 131.

 Obesity, 94, 119, 221, 412.
 Occupation-neuroses, 413.

 Odontalgia, 409, 465.
 Oertel's method, 343, 354, 412,
 492, 498.
 Ohm's law, 168.
 Orchitis, 414.
 Organs of special sense, 40.
 Orthopedics, 101.
 Oscillation, 102, 135.
 Oscillator, 134.
 Osteoma, 217.
 Osteopathy, 102, 129.
 Otitis. See Inflammation. Deaf-
 ness.
 Oudin resonator, 204.
 Ovarian neuralgia, 410.
 Oxidation, 45, 72, 116, 213.
 Oxygen, 31, 32, 145, 298, 449,
 477.
 Ozone, 228, 478.
 Pain, 10, 15, 21, 111, 157, 158,
 198, 211, 225, 414.
 Palpitation of the heart, 414.
 Papilloma, 216, 422.
 Papular skin-diseases, 503.
 Paralysis, 210, 414, 420, 422.
 Paralysis, different forms of,
 421.
 Paresis. See Paralysis.
 Parametritis, 388.
 Passive movements, 115.
 Pelvic adhesions, 422.
 Pelvic cellulitis, 388.
 Pelvic exudates, 390, 422.
 Pericarditis, 423.
 Perimetritis, 388.
 Peritonitis, 91, 424.
 Petrissage, 105.
 Pettenkofer, 38, 65, 144.
 Phagocytosis, 224, 429.
 Pharyngitis, 424.
 Photography, 246, 269.
 Physics of electricity, 166.
 Physics of light, 147.
 Physics of X-rays, 290.
 Physiological methods, 18.
 Physio-therapy defined, 1.
 Piffard's cataphoresis, 398.
 Piffard rays, 424, 500.
 Pigment, 156, 294, 500, 504.
 Piles, 372.
 Pitchblende, 490.
 Plasmodium, 156, 224, 401.
 Pleurisy, 425.
 Pleurodynia, 436, 443.
 Plexus, 128.

- Plumbism. See Constipation.
 Paralysis.
 Pneumatic cabinet or chamber.
 See Compressed air.
 Pneumonia, 91, 425.
 Point of rest, 139.
 Poisons, 18.
 Polarity, 173, 182, 188, 222.
 Pole-changer, 189.
 Polonium, 491.
 Polypus, 214.
 Pope, Curran, 308.
 Positive electrolysis, 213.
 Post-diphtheritic paralysis, 421.
 Potential alternations, 195-198.
 Premature labor, 430.
 Priessnitz, 11, 70, 79, 81, 84, 88,
 94, 378, 451, 484.
 Primary area in hydro-therapy,
 78.
 Proctitis. See Inflammation.
 Progressive muscular atrophy,
 421.
 Prostate gland, enlarged, 430.
 Pruritus, 303, 452, 504. See
 Auto-intoxication.
 Psoriasis, 155, 235, 451, 503.
 Ptomaine-poisoning. See Auto-
 intoxication.
 Pus-germs. See Bacteria.

 Radio-activity, 141, 291, 490.
 Radiography, 245.
 Radio-therapy, 289.
 Radium, 491.
 Rarefied air. See Compressed
 air.
 Rationale of disease, 9.
 Rationale of symptoms, 9.
 Rationale of treatment, 12.
 Raw food, 63.
 Reaction in hydro-therapy, 77,
 80, 96, 437.
 Reactive water-applications, 88.
 Recreation, 461.
 Red light, 149, 162.
 Reflex disorders, 430.
 Resistance, 167.
 Resistance-movements, 115.
 Resonance-effects, 202.
 Rest-cure, 333, 461.
 Restorative symptoms, 10.
 Retention of urine. See Cystitis.
 Reflex disorders.
 Retro-flexion, 360.

 Rheumatism, 21, 56, 87, 99, 115,
 434.
 Rheumatism, muscular, 443.
 Rheumatoid arthritis, 444.
 Rhinitis, 405.
 Rock-crystal, 150.
 Roentgen-rays. See X-rays.
 Rokitanski, 466.
 Roller-cabinet, 177.
 Roman-Irish (dry heat) bath,
 94.
 Russian bath (hot steam bath
 followed by douche and
 massage). See Hydro-
 therapy.

 Salpingitis, 388, 445.
 Sarcoma, 218, 303, 445.
 Scars, 148, 215.
 Scheidel coil, explosion of, 287.
 Schroth, Johann, 364, 365, 367,
 440, 457.
 Schueller's experiments, 77.
 Schwedische Heilgymnastik, 114.
 Sciatica, 221, 410.
 Scleroderma pigmentosum, 452.
 Sclerosis, 393, 394.
 Secondary area in hydro-ther-
 apy, 78.
 Secondary radiations, 258.
 Sepsis, 445.
 Sex-determination, 446.
 Sexual instinct, 42.
 Sexual weakness, 134, 164, 197,
 447.
 Shunt, 171.
 Singultus, 447.
 Sinusoidal current, 176.
 Skiagraphy, 245.
 Skin-diseases, 345, 363, 447.
 Skin-function, 28.
 Skinner, C. E., 441.
 Smallpox, scars of, 148.
 Snow, Arnold, 399, 408.
 Snow's electrodes, 206.
 Soft tube, 242.
 Solarium, 157.
 Spasm, 452.
 Species, 4.
 Spinal cord, 127.
 Sprains, 87, 99, 158, 452.
 Spray, static, 188.
 Static applications, 191.
 Static electricity, 175, 184, 222,
 228.

- Static induced current, 195, 196.
 Static machine, 184.
 Static machine, how to clean, 185.
 Static machine, how to dry, 185.
 Static machine, polarity of, 188.
 Steam-bath, 93.
 Steam-bath for fever-cases, 350.
 Stenosis, 453.
 Stereo-skiagraphy, 276.
 Stiff joints, 453.
 Stitch in the side, 425, 481.
 Stomach, catarrh of. See Dyspepsia.
 Stomach, inflammation of. See Gastritis.
 Stomach-massage, 349.
 Stone. See Calculi.
 Streptococcus pyogenes, 154.
 Strictures, 453.
 Strictures, urethral, 215, 454.
 St. Vitus' dance. See Chorea.
 Suggestion, 142, 143, 229, 431.
 Suggestive element in static electricity, 229.
 Sunbath, 156.
 Sunlight, 147, 156.
 Sunstroke, 86, 454.
 Superfluous hairs, 214, 302, 456.
 Surgery, conservatism in, 22, 218.
 Surging, 195.
 Survival of the fittest, 4, 5.
 Suspension-method in tabes, 397.
 Sweat, 83.
 Swedish movements, 114.
 Swimming for consumptives, 474.
 Sycosis, 155, 452, 503.
 Sympathetic nerves, 128, 131.
 Syphilis, 456.
 Tabes dorsalis, 394.
 Tait, Lawson, 22.
 Tangential rays, 258.
 Tapotement, 105.
 Testicles, inflammation of. See Orchitis.
 Tetanus, 461.
 Therapy of electric currents, 208.
 Therapy of light, 144.
 Therapy of water, 85.
 Therapy of Roentgen (X-) rays, 289.
 Thorium, 491.
 Tic-douloureux, 409.
 Tinea circinata, 452.
 Tinea tonsurans, 214, 303, 503.
 Tissue-builders, 47.
 Tissue-consumers, 47.
 Tobacco, 48, 464.
 Tonsils, enlarged, 356.
 Tooth-ache, 409, 465.
 Torticollis, 22, 125, 436, 443.
 Trachoma, 368.
 Tripet on high frequency, 234.
 Trockenkur. See Schroth, Johann.
 Tubercle-bacillus, 33, 146, 154, 156, 208, 469.
 Tuberculosis, 33, 303.
 Tuberculosis as an economic problem, 34, 482.
 Tuberculosis of glands, 465.
 Tuberculosis of joints, 466.
 Tuberculosis pulmonum, 467.
 Tumors, 210, 212-218, 280.
 Typhoid fever, 10, 38, 70, 484.
 Typhoid fever, relation of water to, 37.
 Ulcer, 488.
 Ulcer, gastric, 365.
 Ultra-violet element in high frequency, 231.
 Ultra-violet element in X-rays, 292.
 Ultra-violet rays, 147, 229, 231, 258, 294.
 Undulation, 137.
 United States, climate of, 488.
 Uranium, 490.
 Uremia, 491.
 Urethral stricture, 454.
 Urethritis, specific, 367.
 Uterine fibroids, 216.
 Uterine hemorrhage, 371.
 Uterine inertia, 491.
 Vacuum of the X-tube, 239, 254.
 Vaginismus, 492.
 Valvular diseases of the heart, 492.
 Vapor-bath, 93, 358.
 Varicose veins, 499.
 Varix, 214, 500.
 Vascular tumors, 214, 500.
 Vegetarian diet, 53.
 Versions of the womb, 501.

- Vertigo. See Nervous disorders.
 Constipation, Dyspepsia.
 Vibration, 102, 123.
 Vibration-tables, 132, 133, 134,
 416.
 Vibratory stimulation, 129.
 Vis medicatrix naturæ, 4, 457.
 Voltage, 166, 168.
 Vomiting of pregnancy, 211, 501.
- Wagner, Richard, 41, 42.
 Walter's radiations, 258, 293.
 Walter's skiameter, 279.
 Warts, 214, 216.
 Water as a physiological element, 47.
 Water, hygienic importance of,
 37.
 Water-applications, different
 kinds of, 86.
 Water-applications, physiological
 effects of, 71.
 Wave-length, 138.
 Wine-marks. See Birth-marks.
 Winternitz, Prof. Wilhelm, 74,
 78, 81, 109, 159, 227, 428.
 Wounds, 162.
 Wrist-drop. See Paralysis.
- Writer's cramp. See Occupa-
 tion-neuroses.
 Wry-neck. See Torticollis.
- X-rays (Roentgen-rays), 236,
 289.
 X-rays, anodyne effects of, 503.
 X-rays in biology, 296.
 X rays, physics of, 290.
 X-rays, ultra-violet element in,
 292.
 X-ray accessories, 278.
 X-ray burns, 282, 501.
 X-ray camera, 260.
 X-ray coil, portable, 501, 502.
 X-ray diagnosis, 236.
 X-ray errors, 273.
 X-ray gloves, 287.
 X-ray statistics, 501.
 X-ray therapy, 289.
 X-ray tubes, 236.
- Zander's method, 120.
 Ziegenspeck, 113.
 Zinc-mercury cataphoresis, 387.
 Zinc silicate, 232.
 Zone of sterilization, 386.
 Zoroaster, 140.

LANE MEDICAL LIBRARY

To avoid fine, this book should be returned on
or before the date last stamped below.

JAN - 6 1933

